

AT MICROFICHE REFERENCE LIBRARY

A project of Volunteers in Asia

Appropriate Technology for Water Supply and
Sanitation. Volume 3: Health Aspects of Excreta
and Sullage Management--A State-of-the-Art Review

by: Richard G. Feachem, David T. Bradley, Hemda
Garelick and D. Duncan Mara

Published by:

The World Bank
1818 H Street, N.W.
Washington, DC 20433 USA

Available from:

The World Bank
Publications Unit
1818 H Street, N.W.
Washington, DC 20433 USA

Reproduced by permission of the World Bank.

Reproduction of this microfiche document in any
form is subject to the same restrictions as those
of the original document.

Appropriate Technology for Water Supply and Sanitation

Health Aspects of Excreta and Sullage Management—A State-of-the-Art Review

by Richard G. Feachem, David J. Bradley, Hemda Garelick,
and D. Duncan Mara

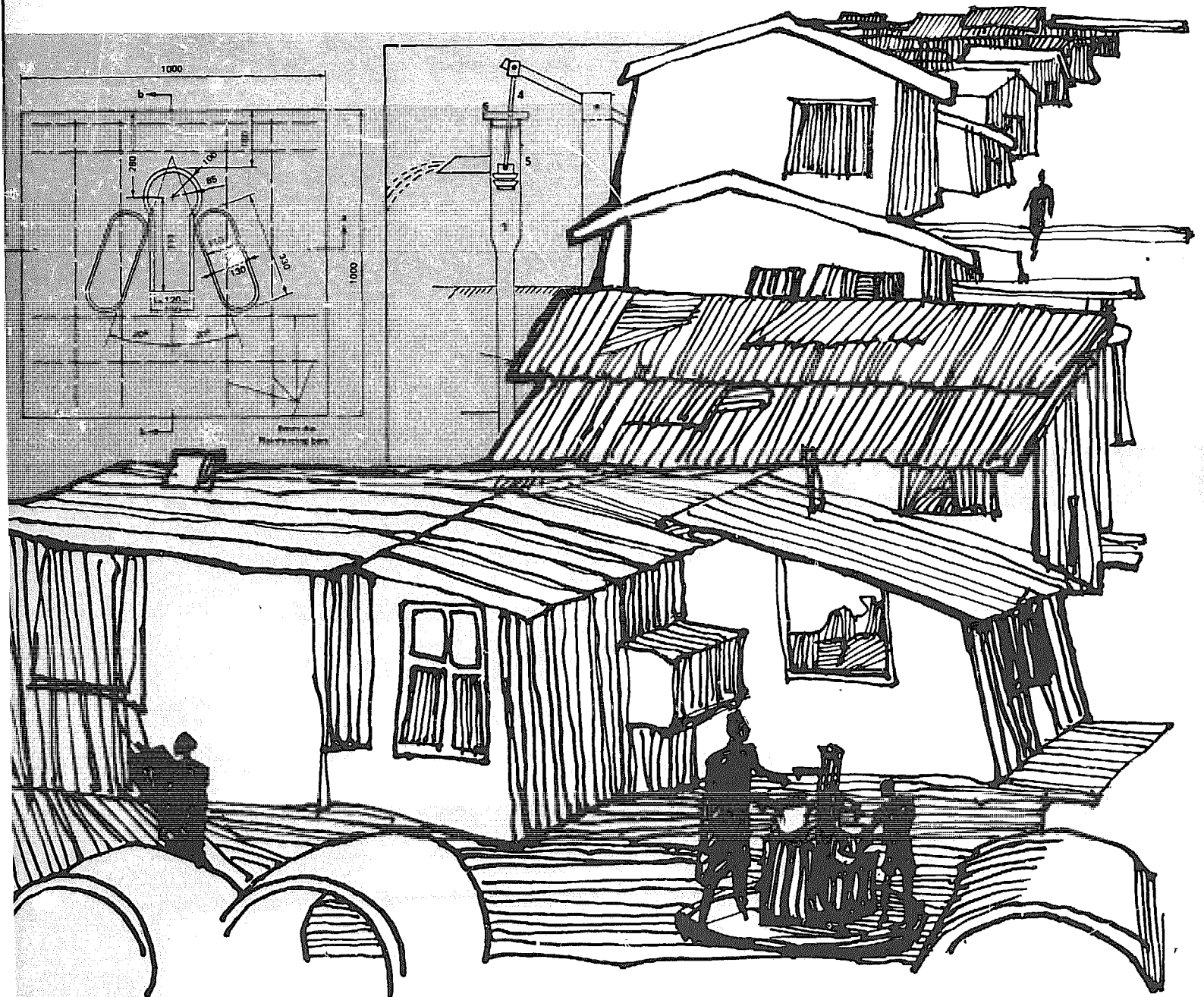

Copyright © 1980 by the International Bank for Reconstruction and
Development/The World Bank

The World Bank enjoys copyright under Protocol 2 of the Universal Copyright Convention. Nevertheless, permission is hereby granted for reproduction of this material, in whole or part, for educational, scientific, or development-related purposes except those involving commercial sale provided that (a) full citation of the source is given and (b) notification in writing is given to the Director of Information and Public Affairs, the World Bank, Washington, D.C. 20433, U.S.A.

APPROPRIATE TECHNOLOGY FOR WATER SUPPLY AND SANITATION

HEALTH ASPECTS OF EXCRETA AND SULLAGE MANAGEMENT:

A STATE-OF-THE-ART REVIEW

The work reported herein represents the views of the authors and not necessarily those of the World Bank, nor does the Bank accept responsibility for accuracy or completeness.

Transportation, Water, and Telecommunications Department

The World Bank

June 1981

A B S T R A C T

Public Health is of central importance in the design and implementation of improved excreta disposal projects. Improvements in health are the main social and economic benefit which planners and economists hope to achieve by investing in excreta disposal. It is therefore necessary to make available as much information as possible about the interaction between excreta and health in order that engineers and planners may make informed and rational decisions. The information that is required not only concerns the broad epidemiological issues of the impact on disease of improvements in excreta disposal, but also the ways in which particular excreta disposal and reuse technologies affect the survival and dissemination of particular pathogens.

This book sets out to provide such information. It is intended for planners, engineers, economists and health workers and has been written with a minimum of jargon so that it can be readily absorbed by people from differing professional backgrounds.

This paper presents a distillation of available knowledge on excreta, night soil, sewage and health. The emphasis is on presenting the complex, and sometimes contradictory, evidence as clearly and concisely as possible.

TABLE OF CONTENTS

	<u>Page No.</u>
PREFACE	v
CHAPTER 1. EXCRETA AND HEALTH	1
CHAPTER 2. THE NATURE OF EXCRETA AND SEWAGE	5
2.1 Quantities	5
2.2 Chemical composition	6
2.3 Pathogens in excreta	14
2.4 Viruses in excreta	14
2.5 Bacteria in excreta	15
2.6 Leptospira	19
2.7 Protozoa in excreta	19
2.8 Helminths in excreta	20
2.9 The hazard from feces	24
2.10 Pathogens in urine	24
CHAPTER 3. THE NATURE OF SULLAGE	27
3.1 Introduction	27
3.2 Quantities	27
3.3 Characteristics of sullage	29
3.4 Health aspects	31
CHAPTER 4. ENVIRONMENTAL CLASSIFICATION OF EXCRETA-RELATED INFECTIONS	33
4.1 Introduction	33
4.2 Key concepts in understanding excreta- related infections	33
4.3 Environmental classification of excreta-related infections	42
CHAPTER 5. THE RISK OF EXCRETA TO THE PUBLIC HEALTH	55
5.1 Introduction	55
5.2 Illustrative sketches	55
5.3 Children	59
5.4 The distribution of sanitation benefits	62
5.5 Health benefits of sanitation	63
5.6 Benefits and impacts	65
CHAPTER 6. FECAL INDICATOR BACTERIA	69
6.1 Introduction	69
6.2 The ideal fecal indicator bacterium	69
6.3 Fecal indicator bacteria	70
6.4 Relationship of fecal indicator bacteria to excreted pathogens	74
6.5 Pathogen indicator organisms	75

CHAPTER 7.	SURVIVAL OF INDICATORS AND PATHOGENS	79
	7.1 Introduction	79
	7.2 Survival in feces, night soil, and sludge	80
	7.3 Survival in water or sewage	81
	7.4 Survival on soil	81
	7.5 Survival on crops	82
CHAPTER 8.	APPROPRIATE PHILOSOPHIES REGARDING PATHOGEN SURVIVAL AND WASTE TREATMENT	85
	8.1 Appropriate philosophies for the consideration of pathogen survival	85
	8.2 Appropriate philosophies for night soil and sewage treatment	86
CHAPTER 9.	HEALTH ASPECTS OF EXCRETA AND NIGHT SOIL SYSTEMS	91
	9.1 Introduction	91
	9.2 Pit latrines	91
	9.3 Composting toilets	95
	9.4 Cartage systems	98
	9.5 Composting	104
	9.6 Summary	108
CHAPTER 10.	HEALTH ASPECTS OF SEWAGE SYSTEMS	111
	10.1 Introduction	111
	10.2 Aquaprivies and septic tanks	111
	10.3 Conventional sewage treatment	116
	10.4 Aerated lagoons	125
	10.5 Oxidation ditches	126
	10.6 Tertiary treatment	126
	10.7 Effluent chlorination	131
	10.8 Waste stabilization ponds	132
	10.9 Summary	134
CHAPTER 11.	THE REUSE OF EXCRETA	137
	11.1 Introduction	137
	11.2 Agricultural Reuse	137
	11.3 Aquaculture reuse	145
	11.4 Biogas production	149
CHAPTER 12.	DISCHARGE OF EFFLUENTS	153
	12.1 Discharge to rivers and lakes	153
	12.2 Discharge to sea	154
	12.3 Discharge to groundwater	156
	12.4 Nitrates	157

CHAPTER 13.	THE HUMAN ELEMENT IN SANITATION SYSTEMS	159
13.1	Introduction	159
13.2	The significance of understandings and values	159
13.3	The significance of social structure and organization	161
13.4	Deposition	162
13.5	Removal systems	165
13.6	Reuse	168
13.7	Improving the management of urban sanitation systems	169
13.8	The role of self-help schemes	170
13.9	Health education	172

APPENDICES

REFERENCES

PREFACE

Most people in the less developed countries do not have an adequate excreta disposal system. A survey by the World Health Organization in 1975 indicated that 75 percent of urban dwellers did not have sewerage (i.e., sewers for disposal of excreta), while 25 percent had no system of any kind. In rural areas it was reported that 85 percent lacked any adequate excreta disposal facility. Clearly, the situation is most serious and major national and international initiatives are required if any substantial impact is to be made on the problem in the next few decades.

Public health is of central importance in the design and implementation of improved excreta disposal projects. Improvements in health are the main social and economic benefit that planners and economists hope to achieve by investing in excreta disposal. It is therefore necessary to make available as much information as possible about the interaction between excreta and health to enable engineers and planners to make informed and rational decisions. The information that is required not only concerns the broad epidemiological issues of the impact on disease of improvements in excreta disposal, but also the ways in which particular excreta disposal and reuse technologies affect the survival and dissemination of particular pathogens.

This report sets out to provide such information. It is intended for planners, engineers, economists, and health workers and has been written with a minimum of jargon so that it can be readily absorbed by people from differing professional backgrounds.

This report presents a distillation of available knowledge on excreta, night soil, and sewage and health. The emphasis is on presenting the complex, and sometimes contradictory, evidence as clearly and concisely as possible. The information is drawn largely from the available literature -- but not entirely. On occasion we have gone beyond the literature to make statements about what we anticipate to be the case based on a fundamental understanding of a particular disease or pathogen. Inevitably, the need for clarity and limited space have necessitated some oversimplifications.

This report is an abbreviated version of Feachem et al., (forthcoming) which contains a short account of each excreta-related infection briefly considered here, stressing in more detail the appropriate control methods and the role of improved excreta disposal in any control campaign. These accounts have been revised and updated since this report was completed. Emphasis is also given in the book to the survival of the pathogen outside its host in order that the effect of various waste treatment processes may be clarified. Like the present volume, this material is derived from the literature. Where the literature is ambiguous or contradictory, we have attempted to give a conservative opinion; for instance, we overestimate the ability of the pathogen to survive hostile environmental conditions. Readers of this report are referred to the more extensive coverage of the literature contained in the book-length study. The literature selected therein is drawn from throughout the world, and a considerable number of Czech, French, German, Japanese, Korean, Russian, Spanish, and other non-English language publications have been listed. Contributors to the book included: J. Coghlan, C.F. Curtis, D.M.E. Curtis, W.A.M. Cutting, B.S. Drasar, B.R. Laurence, B. Lloyd, W.W. Macdonald, D.M. Mackay, R.L. Muller, J.S. Slade, B.A. Southgate, D.C. Warhurst, and A.J. Zuckerman.

A variety of technical terms used by the medical and engineering professions are found in this report. These terms have not always been used in a consistent way in the literature. We have therefore compiled a list of definitions (appendix I) that clarifies the exact meanings we attach to these terms in this report. The reader may find it useful to refer to appendix I before proceeding further.

This report has been prepared by the Ross Institute of Tropical Hygiene from the work of a group of bacteriologists, engineers, entomologists, epidemiologists, parasitologists, and virologists drawn from the London School of Hygiene and Tropical Medicine and elsewhere. The work has been carried out as part of the World Bank's research project on appropriate technology for water supply and sanitation. A complete list of publications issued as a result of this project is contained in Chapter I. Financial assistance has been provided by the World Bank and the authors are indebted to the staff of the World Bank for their support and encouragement during the preparation of the report. The authors are particularly grateful for the guidance given by Mr. John Kalbermatten, Mr. Charles Gunnerson, Dr. DeAnne Julius, and Mr. Richard Middleton.

We also wish to thank Dr. V.J. Cabelli, Dr. W. Crewe, Dr. B. Cvjetanovic, Mr. C. Gunnerson, Dr. J.M. Hughes, Dr. D. Julius, Mr. J. Kalbermatten, Dr. J.C. Leighty, Mr. R. Middleton, Dr. F.D. Miller, Mr. W.L. Reyes, Dr. H.I. Shuval, Dr. B.B. Sundaresan, Prof. A. Wolman, and Prof. A.M. Wright who kindly reviewed the manuscript of this report and made many thoughtful and constructive suggestions. Thanks are also due to many other people who assisted in various ways and especially to Dr. F.I.C. Apted, Ms. P. Berrington, Ms. E. Burge, Margaret Carroll, Mr. P. Hawkins, Professor K. Ives, Dr. M. McGarry, and Mr. C. Miller. We also acknowledge the valuable work of translation carried out by Sandy Cairncross (Portuguese), Mario Campa (Italian), Agnes Candler (French), Zuzana Feachem (Czech, Slovak, and Russian), and Rieko Fukano (Japanese).

Richard G. Feachem
David J. Bradley
Hemda Garelick
D. Duncan Mara

T A B L E S

	<u>Page</u>
1. Fecal weights around the world.	8
2. Composition of human feces and urine.	10
3. Possible BOD ₅ content of excreta and night soil.	12
4. Some reported <u>per capita</u> BOD ₅ contributions in sewage.	13
5. Viral pathogens excreted in feces.	15
6. Fecal microflora of different human populations.	16
7. Bacterial pathogens excreted in feces.	18
8. Protozoal pathogens excreted in feces.	20
9. Helminthic pathogens excreted in feces.	22
10. Possible output of some pathogens in the feces and sewage of a tropical community.	25
11. Water use in sewerless rural households in selected developing countries.	28
12. Pollution loads of wastewater as sampled from each plumbing fixture.	30
13. The bacterial content of sullage in the U.S.A.	30
14. Some basic features of excreted infections.	43
15. Environmental classification of excreted infections.	47
16. The age of maximum prevalence of some major excreted infections in indigenous populations of endemic areas.	60
17. A speculative ranking of eight excreta disposal technologies based upon four criteria.	68
18. Pathogen content anticipated in final product of anaerobic composting toilets operating at ambient temperatures in warm climates.	87
19. Summary of pathogen removal by various sewage treatment processes.	109

F I G U R E S

	<u>Page</u>	
Figure 1	Main ways of excreta's relation to ill health	35
Figure 2	Involvement of other vertebrates in transmission of human excreted infections	41
Figure 3	Survival outside host of excreted pathogens over time	49
Figure 4	Length and dispersion of transmission cycles of excreted infections	50
Figure 5	Section of a pit latrine	92
Figure 6	Vented improved pit latrine	93
Figure 7	ROEC pit latrine	94
Figure 8	"Multum" style continuous composting toilet	96
Figure 9	Single-family-double-vault composting latrine	97
Figure 10	Pathogen flow through a batch composting toilet	99
Figure 11	Bucket latrine with squatting slab	101
Figure 12	Household night-soil collection (with vault and vacuum truck)	102
Figure 13	Influence of time and temperature on selected pathogens in night-soil and sludge	106
Figure 14	Pathogen flow through well-managed thermophilic composting process	107
Figure 15	Two-compartment septic tank	112
Figure 16	Self-topping aqua privy	113
Figure 17	Pathogen flow through septic tank	115
Figure 18	Pathogen flow through various continuous sludge treatment processes	120
Figure 19	Pathogen flow through various batch sludge-treatment processes	121
Figure 20	Pathogen flow through conventional sewage treatment plant featuring trickling filters	123
Figure 21	Pathogen flow through conventional sewage treatment plant featuring activated sludge	124
Figure 22	Flow diagram for aerated lagoon incorporated sludge-digestion	127
Figure 23	Flow diagram for oxidation ditch	128
Figure 24	Stages in development of a waste stabilization pond-aerated lagoon system	129
Figure 25	Pathogen flow through waste-stabilization ponds system	135
Figure 26	Two biogas plant designs	150

A P P E N D I C E S

- I. Glossary of technical terms.
- II. Uncritical summary of some literature on the impact of improved excreta disposal.
- III. Reported survival times for excreted organisms in feces, night soil, and sludge.
- IV. Reported survival times for excreted organisms in water and sewage.
- V. Survival of excreted organisms in soil.
- VI. Reported survival times for excreted organisms on crops.
- VII. Reported survival times for excreted organisms in composting plants.
- VIII. Reported survival data for excreted organisms in Imhoff tanks and septic tanks.
- IX. Reported survival data for excreted organisms in primary sedimentation.
- X. Reported survival data for excreted organisms in trickling filters.
- XI. Reported survival data for excreted organisms in activated sludge.
- XII. Reported survival data for excreted organisms in sludge digestion plants.
- XIII. Reported survival data for excreted organisms in sludge dewatering and drying plants.
- XIV. Reported survival data for excreted organisms in waste stabilization ponds.

CHAPTER I

EXCRETA AND HEALTH

This report is about human excreta and disease. Excreta are defined here as human urine and feces. Many infections, in excess of fifty even if the different numbered types of viruses and serotypes of enteric bacteria are ignored, are transmitted from the excreta of an infected person to the mouth of another. The disease-causing agents (the pathogens) of these infections travel from anus (or, rarely, the bladder) to mouth by a variety of routes -- sometimes directly on dirty fingers and sometimes on food or utensils, in water, or by any other route that allows minute amounts of infected excreta to be ingested. Some of these pathogens may reinfect, not only through the mouth, but by inhalation of dust or aerosol droplets. There are also a few infections (notably hookworm and schistosomiasis) that can penetrate through the skin.

Human excreta are the principal vehicle for the transmission and spread of a wide range of communicable diseases. Some of these diseases rank among the chief causes of sickness and death in societies where poverty and malnutrition are ubiquitous. Diarrheas, for instance, are, together with malnutrition, respiratory disease, and endemic malaria, the main cause of death among small children and infants in developing countries. Cholera, whether endemic or epidemic in form, is accompanied by numerous deaths in all age groups -- although under endemic conditions, it is children who suffer the most fatalities. Other diseases, such as hookworm infection and schistosomiasis, cause chronic debilitating conditions that impair the quality of life (however defined) and make the individuals more liable to die from superimposed acute infections.

These diseases, and the many others that are discussed in this report, start their journey from an infected individual to a new victim when the causative agent is passed in the excreta. Therefore, the collection, transportation, treatment, and disposal of human excreta are of the utmost importance in the protection of the health of any community. They become even more important in those societies that recognize the value of human excreta in agriculture, aquaculture, or biogas production and therefore reuse, rather than dispose of, the raw or treated wastes. Such reuse systems have a positive role in supporting economic activity and food production and are often cheaper than alternative methods of disposal. Nevertheless, reuse systems present a challenge to the public health engineer to design and develop technologies that will not pose unacceptable risks to health.

In most countries there are millions of people who lack any hygienic and acceptable method of excreta disposal. There are also governments and international agencies spending, or preparing to spend, large sums of money to improve this situation. If these governments and agencies could arrange, by massive investment and miraculous social and economic transformation, to provide everyone with a modern house with water and sewerage connections, the health concerns discussed in this book would be less relevant. But change will not come in this way. Change will come slowly and unevenly and resources of money, manpower, and institutions will often be scarce.

The recipients of new excreta disposal technologies may be unable to completely pay for them, or they may lack the necessary experience and education to use them effectively. There will always be many constraints, and with these constraints will come difficult choices.

Choices need to be made about all aspects of excreta disposal. There will be choices about technology, ultimate disposal, reuse, sullage, payment, management, and all the other elements that make up a sewage or night soil system. A number of factors will influence these choices, but one central factor is health. Since a primary motivation for investing in excreta disposal is improved health, decision makers will need to understand the health implications of the various choices. The more limited the resources, the more difficult the choices and decisions become and the more it is necessary to understand precisely and in detail the relationships between excreta and health.

The object of this report is to present to the educated, but nonspecialist, reader the information about excreta and health that will enable him to make informed decisions and to allocate limited resources in a way likely to be most beneficial to the public health. Our purpose is not to provide technical details of the excreta disposal systems discussed. A companion review and bibliography on the technical aspects has been prepared and published by the International Development Research Centre (IDRC) in Ottawa (Rybczynski, Polprasert, and McGarry, 1978). Readers are strongly recommended to use the two books together and to consult the other volumes in the World Bank's series of publications entitled Appropriate Technology for Water Supply and Sanitation of which this report is volume 3. Other volumes in this series are as follows:

- [vol. 1] Technical and Economic Options, by John M. Kalbermatten, DeAnne S. Julius, and Charles G. Gunnerson [a condensation of Appropriate Sanitation Alternatives: A Technical and Economic Appraisal, forthcoming from Johns Hopkins University Press]

- [vol. 1a] A Summary of Technical and Economic Options

- [vol. 2] A Planner's Guide, by John M. Kalbermatten, DeAnne S. Julius, Charles G. Gunnerson, and D. Duncan Mara [a condensation of Appropriate Sanitation Alternatives: A Planning and Design Manual, forthcoming from Johns Hopkins University Press]

- [vol. 4] Low-Cost Technology Options for Sanitation--A State-of-the-Art Review and Annotated Bibliography, by Witold Rybczynski, Chongrak Polprasert, and Michael McGarry [available, as a joint publication, from the International Development Research Centre, Ottawa, Ontario, Canada]
- [vol. 5] Sociocultural Aspects of Water Supply and Excreta Disposal, by Mary Elmendorf and Patricia K. Buckles
- [vol. 6] Country Studies in Sanitation Alternatives, by Richard A. Kuhlthau (ed.)
- [vol. 7] Alternative Sanitation Technologies for Urban Areas in Africa, by Richard G. Feachem, D. Duncan Mara, and Kenneth O. Iwugo
- [vol. 8] Seven Case Studies of Rural and Urban Fringe Areas in Latin America, by Mary Elmendorf (coordinating anthropologist)
- [vol. 9] Low-Cost Water System Design, Section 1 by Donald T. Lauria, Peter J. Kolsky, and Richard N. Middleton; Section 2 by Keith Demke and Donald T. Lauria; and Section 3 by Paul V. Hebert
- [vol. 10] Night-soil Composting, by H. I. Shuval, Charles G. Gunnerson, and DeAnne S. Julius
- [vol. 11] Sanitation Field Manual, by John M. Kalbermatten, DeAnne S. Julius, Charles G. Gunnerson, and D. Duncan Mara
- [vol. 12] Low-Cost Water Distribution--A Field Manual, by Charles Spangler

The more complete book versions of volumes 1, 2 and 3 are forthcoming -- under the series titles "World Bank Studies in Water Supply and Sanitation" -- from the Johns Hopkins University Press (Baltimore and London).

Additional volumes and occasional papers will be published as ongoing research is completed. With the exception of volume 4, all reports may be obtained from the World Bank's Publications Unit.

Other useful publications, which may be read in conjunction with this book, are Feachem and Cairncross (1978), Feachem, McGarry, and Mara (1977), Gotaas (1956), McGarry and Stainforth (1978), Mara (1976), Okun and Ponghis (1975), Rajagopalan and Shiffman (1974), Shuval (1977), and Wagner and Lanoix (1958).

CHAPTER 2

THE NATURE OF EXCRETA AND SEWAGE

2.1 QUANTITIES

There are very marked differences in the volumes of excreta and sewage produced by different communities. Volumes, composition, and consistency of feces depend on such factors as diet, climate, and state of health. Individual wet fecal weights vary from under 20 grams daily to 1.5 kilograms daily. When national or regional averages are considered, however, Europeans and North Americans produce between 100 and 200 grams daily, while people in developing countries have average wet fecal weights of 130-520 grams daily. Vegetarians generally have higher fecal weights than other groups, and fecal weights in rural areas are considerably higher than in towns. Children, adolescents, and the elderly have lower fecal output than others. Table 1 shows wet fecal weight data reported by various authors from a range of countries.

The water content of feces varies with fecal weight. For instance, in a community with an average wet fecal weight of 100-150 grams daily, the water content will be around 75 percent. As fecal weight increases, so does the proportion of water, so that, at a fecal weight of 500 grams daily, the water content of the stool may be about 90 percent. The frequency of defecation also varies with fecal weight. In Europe and North America, where fecal weights are generally under 200 grams daily, the average frequency is one stool per day. In rural areas of developing countries, especially where diet is vegetarian and fecal weights are high, two or three stools per day is common.^{1/}

Most adults will produce between 1.0 and 1.3 kilograms of urine per day, but this depends on how much they drink and sweat, which in turn depends on diet, occupation, climate, and other factors.

Where possible, local data sources should be consulted when designing a night-soil ^{2/} system. In the absence of other data, a working assumption in a developing country is that adults will produce about 350 grams of feces and 1.2 kilograms of urine per day in rural areas and 250 grams of feces and 1.2 kilograms of urine in urban areas.

Volumes of night soil produced for cartage and treatment may be computed from the sum of the per capita contributions of feces and urine plus any water used for ablution or for cleaning the toilet area. Typically, night-soil volumes are in the range 1.5-2.0 liters per capita daily. Data

1. We are indebted to Dr. John Cummings of the MRC Dunn Nutrition Unit, University of Cambridge, for providing the information reported here and in Table 1.

2. For definitions of this and other technical terms see the glossary, appendix I.

from Kiangsu Province, China, show that a bucket latrine system produces 2 liters of waste per capita daily including the bucket washwater (McGarry and Stainforth, 1978).

Volumes of domestic sewage depend on quantities of water used in the home. Houses connected to sewers are normally also connected to water and usually have comprehensive plumbing fittings. Such houses may, rarely, use as little as 30 liters per capita per day (White, 1977) but, if use falls below 50 liters per capita daily, the sewers are liable to lose their self-cleansing flow and become frequently blocked. At the other end of the scale, households with many water using devices (such as washing machines) may use 300 liters or more per capita daily.

The consistency or solids content of night soil may be calculated from these figures. Assume a fecal weight of 250 grams per capita daily with a water content of 80 percent. Further assume a urine production of 1.2 liters per capita per day and 0.35 liter of water used for anal cleansing. Then the night soil of one individual will contain 50 grams of solids in 1.8 liters of night soil, in other words, a solids content of 2.8 percent. If paper is used for anal cleansing, solids content will go up to perhaps 5 percent. Therefore the solids content of night soil is similar to that of primary sewage works' sludge. Data from Japan, Taiwan, and Thailand indicate a solids content for night soil in the range 2.0-4.2 percent, with mean figures of 2.7-3.7 percent (Pescod, 1971).

2.2 CHEMICAL COMPOSITION

Excreta, especially feces, are of very complex and variable composition. Some typical figures on some constituents are given in Table 2. Of particular interest to the sanitary engineer are the data on carbon and nitrogen content, which indicate that the C/N ratio in feces is in the region of 8, while in urine it is under 1. These figures have considerable bearing on the design of the composting systems where the C/N ratio needs to be around 20-30 for the process to proceed efficiently (Gotaas, 1956).

The other parameter of great importance to the public health engineer is the concentration of organic material, measured by the biochemical oxygen demand (BOD)^{1/} or other similar index, such as COD (chemical oxygen demand ^{2/}, or total organic carbon). In a night-soil system, the per

1. The biochemical oxygen demand is the mass of oxygen required by microorganisms to oxidize the organic content of the waste. It is an indirect measure of the concentration of biodegradable material present. BOD₅ denotes the oxygen demand exerted during the standard test, which is conducted at 20°C over five days.

2. The chemical oxygen demand is the mass of oxygen consumed when the organic matter present is oxidized by strong oxidizing agents in acid solution. It includes some substances (such as cellulose) that are not available to microorganisms, but excludes some (such as acetic acid) that are.

capita BOD₅ contribution is made by the paper or other material used for anal cleansing. In the U.S.A., Laak (1974) has found that urine contains 8.6 grams of BOD₅ per liter and feces contain 9.6 grams per 100 grams. Clearly, as fecal weights increase and moisture content rises, the BOD₅ contribution per unit weight of wet feces will fall. In addition, it is possible that higher fecal weights will be associated with a higher fiber content, which may not be readily biodegradable. This would cause higher fecal weights to be accompanied by lower BOD₅ contributions per unit weight of dry feces.

Table 1. Fecal Weights around the World

Subject	Number	Average wet fecal weight (grams daily)	Fecal weight (range)	Source
<u>U.K.</u>				
Naval recruits and wives	15	94	(39-223))))) Burkitt, Walker, and Painter (1972)
Teenage boarding school pupils	9	110	(71-142)	
Vegetarians	24	225	(71-488)	
Hospital patients with fiber added to diet	6	175	(128-248)	
Laboratory staff	4	162	(123-224)	Greenberg (1976)
Medical students	33	132	--	Cummings (unpublished)
Medical personnel	11	107	--	Goy <u>et al.</u> (1976)
<u>U.S.A.</u>				
Cincinnati	5	115	(76-148)	Connell and Smith (1974)
Philadelphia students)) Goldsmith and Burkitt (1975)
- Black	10	148	--	
- White	10	192	--	
San Francisco medical personnel	5	91	--	Gray and Tainter (1941)
Norwalk, volunteers	6	103	--	Fuchs, Dorfman, and Floch (1976)
<u>SOUTH AMERICA</u>				
Villagers Shipibo Indians, Peru	20	325	(60-650)	Crofts (1975)
<u>KENYA</u>				
Hospital staff rural Chogoria	16	520	--	Cranston and Burkitt (1975)

(Table continues on following page.)

Table 1 (continued)

Subject	Number	Average wet fecal weight (grams daily) (range)		Source
<u>UGANDA</u>				
Senior boarding-school pupils	27	185	(48-348))) Burkitt, Walker, and Painter (1972)
Rural villagers	15	470	(178-980)	
<u>INDIA</u>				
Nurses	13	155	--)) Burkitt, Walker, and Painter (1972)
Healthy Indians in Nutrition Unit New Delhi)) Tandon and Tandon (1975)
<15 yrs	36	374	(50-1060))
>15 yrs	314	311	(19-1505))
<u>MALAYSIA</u>				
Chinese (urban)	1	277	(180-270)))
Chinese (rural)	10	489	(386-582)))
Malay (rural)	10	465	(350-550)))
Indian (urban)	5	170	(110-240))) Balasegaram and Burkitt (1976)
Indian (rural)	8	385	(255-520)))
Doctors (urban)	6	135	(40-300)))
<u>SOUTH AFRICA</u>				
Young schoolchildren (rural)	--	--	(60-70)))
Older schoolchildren (rural)	--	--	(120-180))) Walker (1975)
Adults (rural)	--	--	(140-220)))
Young children (urban)	--	--	(55-70)))
Older children (urban)	--	--	(100-170)))
Adults (urban)	--	--	(120-180))) Burkitt, Walker, and Painter (1974)
Students	100	173	(120-195)))
Schoolchildren (urban)	--	165	(129-260))) Burkitt, Walker, and Painter (1972)
Schoolchildren (rural)	--	275	(150-350)))

Table 2: Composition of Human Feces and Urine

Item	Feces	Urine
Quantity (wet) per person daily	100-400 g	1.0-1.31 kg
Quantity (dry solids) per person daily	30-60 g	50-70 g
Moisture content (percent)	70-85	93-96
Approximate composition (percent dry weight)		
Organic matter	88-97	65-85
Nitrogen	5.0-7.0	15-19
Phosphorus (as P_2O_5)	3.0-5.4	2.5-5.0
Potassium (as K_2O)	1.0-2.5	3.0-4.5
Carbon	44-55	11-17
Calcium (as CaO)	4.5	4.5-6.0

Source: Adapted from Gotaas (1956).

We have calculated possible BOD₅ contribution at different fecal weights in Table 3. In the absence of other data these are speculative calculations and require confirmation by field testing. Laak (1974) has found that the BOD₅ contribution of anal cleansing paper in the U.S.A. is 3.5 grams per capita daily, and this figure may be lower in some developing countries where water or nonbiodegradable material is used. Where heavy paper (cement bags or newspaper), corncobs, or leaves are used, however, the contribution of anal cleansing material may be similar to that in the U.S.A. Speculative figures have been added to Table 3 to cover the contribution of anal cleansing to the BOD₅ in night soil.

Assuming a total volume of 1.5 liters per adult daily from excreta and anal cleansing material, it is possible to calculate the BOD₅ strength of a night soil produced by adults. These figures are given in Table 3. When allowance is made for children, although the weights of BOD₅ per child will be lower, the volumes will also be lower, so that the concentration may be similar and the final night soil strength may be as calculated. Pradt (1971) found a night soil BOD₅ content of 10,000 milligrams per liter in Japan, and Hindhaugh (1973) found 46,000 milligrams per liter of BOD₅ in Lagos night soil. This last figure is extremely high and may be due to the practice in Lagos of putting garbage in the night-soil buckets.^{1/} However, the volume of night soil produced in Lagos is about 1.5 liters per capita per day -- the figure assumed in Table 3.

1. The reason why garbage is placed in the buckets may be the lack of an adequate refuse disposal system. Huponu-Wusu and Daniel (1977) record that only 35 percent of 1,099 randomly sampled households in metropolitan Lagos are covered by the refuse collection service of the city council.

Table 3: Possible ROD₅ Content of Excreta and Night Soil a/

Population	Assumed adult fecal weight per day <u>b/</u> (grams)	Assumed adult urine weight per day (kilograms)	Estimated percentage water in feces	BOD ₅ per gram of wet feces <u>c/</u> (milligrams)	BOD ₅ per adult per day in feces (grams)	ROD ₅ per adult per day in urine (grams)	ROD ₅ per adult per day in excreta (grams)	BOD ₅ per adult per day in anal cleansing material (grams)	BOD ₅ Strength of night soil assuming that 1.5 liters are produced per adult daily (milligrams per liter)
Europe/ N. America	150	1.2	75	96 <u>d/</u>	14.4	10.3	24.7	3.5 <u>d/</u>	18,800
Developing country, urban	250	1.2	80	77	19.3	10.3	29.6	3.0 <u>e/</u>	21,700
Developing country, rural	350	1.2	85	58	20.3	10.3	30.6	2.0 <u>e/</u>	21,700

a. This table is speculative and should not be used where actual data are available.

b. Fecal weights taken from the ranges indicated in Table 1.

c. Calculated by assuming that the BOD₅ contribution is constant per unit weight of dry feces. This assumption is unlikely to be accurate since, as fecal weight increases, so will the proportion of fiber and fiber is not readily biodegradable.

d. From Laak (1974).

e. Where water is used for anal cleansing, this figure will be 0.

In a sewerage system, the per capita BOD₅ contribution is augmented by sillage, which will contain organic wastes and thus exert an oxygen demand. Typical figures for sewage including sillage are presented in Table 4. Further information on the BOD₅ in sillage will be found in chapter 3.

Table 4: Some Reported per capita BOD₅ Contributions in Sewage

Area	BOD ₅ per capita daily in sewage (grams)
Africa	36
Argentina	54
Australia	23-40
E. Asia	43
India	30-55
Brazil (Sao Paulo)	50
France (rural)	24-34
U.K.	50-59
S.A.	45-78

Note: These figures were calculated by measuring the BOD₅ of raw sewage and multiplying by the estimated water use per capita per day. This gives a most approximate result because urban sewage may contain a substantial proportion of commercial and industrial wastes. The domestic water use and domestic BOD₅ conditions are not readily derived from data on total urban sewage. These figures are not directly comparable with those in Table 3.

2.3 PATHOGENS IN EXCRETA

Although it is not our intention that the biological classification of organisms that cause disease should figure largely here, a brief note on the major agents involved may assist the reader. They comprise four groups of microbes -- viruses, bacteria, leptospirae, and protozoa, to place them in ascending order of size -- together with worms parasitic to man, grouped together under the term helminths. In addition, excreta disposal may affect the breeding of insects, including cockroaches, flies, and mosquitoes, which all have nuisance value and may act as vectors of human disease agents that may themselves not be found in the feces or urine.

2.4 VIRUSES IN EXCRETA

Numerous viruses may infect the intestinal tract and be passed in the feces. Five groups of pathogenic viruses are particularly important: polioviruses, echoviruses, coxsackieviruses, rotaviruses, and hepatitis A virus, but other types are not unusual. The first three of these belong to the family of enteroviruses, all of which replicate in the intestinal tract. Other virus groups include parvo-like viruses and adenoviruses. The latter are mainly respiratory tract viruses but have been found in the feces of children with diarrhea. Many infections, especially in children, are sub-clinical with all these.

Polioviruses are excreted in human feces and infect a new human host by ingestion or inhalation. Most infections do not give rise to any clinical illness. Sometimes, however, infection leads to mild influenza-like illness, to virus-meningitis, or to paralytic poliomyelitis, which may lead to permanent disability or death. It is estimated that paralytic poliomyelitis occurs in only about one out of every 1,000 poliovirus infections, but almost everyone becomes infected in developing countries.

Echoviruses are expected in the feces. Infection can cause simple fever, meningitis, diarrheal disease, or respiratory illness.

Coxsackieviruses are excreted in the feces of infected individuals. Infection can lead to meningitis, fevers, respiratory disease, paralysis, myocarditis, and other conditions.

Rotaviruses are an apparently important group recently found in the feces of a surprisingly large number of cases of infant diarrhea. Their precise causative role or epidemiology is as yet undefined, but they may prove to be responsible for the majority of infant diarrheas.

Hepatitis A virus is the causative agent of infectious hepatitis. It is excreted in the feces and infection may lead to jaundice but is often without symptoms, especially in young children.

These excreted viruses are summarized in Table 5.

Table 5: Viral Pathogens Excreted in Feces

Virus	Disease	Symptomless human carrier state?	Reservoir
Polioviruses	Poliomyelitis; paralysis and other conditions	Yes	Man
Echoviruses	Numerous conditions	Yes	Man
Coxsackieviruses	Numerous conditions	Yes	Man
Reoviruses	Numerous conditions	Yes	?
Adenoviruses	Numerous conditions	Yes	Man
Hepatitis A virus	Infectious hepatitis	Yes	Man
Rotaviruses	Diarrhea or gastroenteritis in children	Yes	?

2.5 BACTERIA IN EXCRETA (excluding Leptospira)

The feces of a healthy person contain large numbers of commensal bacteria of many species. The species of bacteria found in the normal stool and the relative numbers of different species will vary among communities. Table 6 lists the bacteria most commonly found and indicates the variations in their concentrations in feces. Because these bacteria are ubiquitous and numerous in the feces of healthy people, they have been used as indicators of fecal pollution (chapter 6). The most widely used indicator has been the fecal coliform (Escherichia coli), which is the main constituent of the enterobacteria group in Table 6. Enterococci (or, more generally, fecal streptococci), another widespread commensal group, are also used as indicators. Anaerobic bacteria, such as Clostridium, Bacteroides, and Bifidobacterium, have been employed in the past and their role as potential indicators is attracting increasing attention at the present time (Evison and James, 1977). The use of indicator organisms is discussed in more detail in chapter 6.

Table 6: Fecal Microflora of Different Human Populations a/

Diet	Country	Mean log ₁₀ no. of bacteria per gram of feces						
		Enterobacteria <u>b/</u> , <u>c/</u>	Enterococci <u>c/</u>	Lactobacilli	Clostridia	Bacteroides	Bifidobacteria	Eubacteria
Largely carbohydrate	India	7.9	7.3	7.6	5.7	9.2	9.6	9.5
	Japan	9.4	8.1	7.4	5.6	9.4	9.7	9.6
	Uganda	8.0	7.0	7.2	5.1	8.2	9.4	9.3
	Hong Kong	7.0	5.8	6.1	4.7	9.8	9.1	8.5
Mixed Western	England	7.9	5.8	6.5	5.7	9.8	9.9	9.3
	Scotland	7.6	5.3	7.7	5.6	9.8	9.9	9.3
	U.S.A.	7.4	5.9	6.5	5.4	9.7	9.9	9.3
	Denmark	7.0	6.8	6.4	6.3	9.8	9.9	9.3
	Finland	7.0	7.8	8.0	6.2	9.7	9.7	9.5

a. Data collected by Dr. B. Drasar.

b. This group is chiefly comprised of Escherichia coli.

c. These two groups are the most commonly used fecal indicator bacteria.

On occasion, some bacteria listed in Table 6, or particular strains of them, may give rise to disease, as may other groups of bacteria not normally found in the healthy intestine. These pathogenic, or potentially pathogenic, bacteria are listed in Table 7. These bacterial pathogens most commonly enter a new host by ingestion (in water, on food, on fingers, on dirt, and so forth), but some may also enter through the lungs, following inhalation of aerosol particles, or by way of the eye, following the rubbing of the eye with fecally contaminated fingers. At some time during the course of an infection large numbers of the bacteria will be passed in the feces, thus allowing the infection to be spread to new hosts.

Diarrhea is a major symptom of many intestinal infections. The bacteria may invade the body from the alimentary tract and cause either generalized or localized bacterial infections. This invasion is characteristic of typhoid infections and other enteric fevers caused by salmonellae. During infections that are restricted to the digestive system, bacteria will be passed out in the feces only. When invasion has occurred, bacteria may be passed in the urine and will be found in the bloodstream at some stage.

With all the infections listed in Table 7, a carrier state occurs and thus, in communities where these infections are endemic, a proportion of perfectly healthy individuals will be excreting these bacteria. These carriers may play a prominent role in transmitting the infection they carry because they are mobile and hence their feces may be widely dispersed. For instance, a patient with severe cholera will be in bed for most of the time that he is excreting Vibrio cholerae. Those who nurse him are clearly at risk, but he is not disseminating bacteria widely around the community. A mild case, or carrier, by contrast, may look relatively healthy and be mobile and may excrete up to 10^6 cholera vibrios per gram of feces. In some infections the carrier state lasts for a similar duration to the illness, but in others it may persist for months or even be lifelong. Some carriers may have been ill but continue to excrete the bacteria, while others may have been healthy throughout. A carrier becomes especially dangerous if he is engaged in food preparation or handling or if he works at a water supply facility.

Some of the pathogens listed in Table 7 are excreted entirely, or almost entirely, by man, while others are excreted by a wide range of animals. This is significant for the control of the infection through changes in excreta disposal facilities alone, because any improvement made can have no effect upon transmission from animal feces to man. It is noteworthy, however, that three of the major infections listed in Table 7 -- namely typhoid, shigellosis, and cholera -- may be assumed to be infections exclusively of human beings, and spread from one to another.

Table 7: Bacterial Pathogens Excreted in Feces

Bacteria	Disease	Bacteria also passed in urine?	Symptomless human carrier state	Reservoir
<u>Salmonella typhi</u>	Typhoid fever	Yes	Yes	Man
<u>Salmonella paratyphi</u>	Paratyphoid fever	Yes	Yes	Man
Other salmonellae	Food poisoning and other salmonellosis	No	Yes	Man and animals
<u>Shigella</u>	Bacillary dysentery	No	Yes	Man
<u>Vibrio cholerae</u>	Cholera	No	Yes	Man
Other vibrios	Diarrhea	No	Yes	Man (and animals?)
Pathogenic <u>E. coli</u>	Diarrhea or gastroenteritis	No	Yes	Man <u>a/</u>
<u>Yersinia</u>	Yersiniosis	Yes	Yes	Animals and man <u>b/</u>
<u>Campylobacter</u>	Diarrhea	No	Yes	Animals and man(?)

a. Although many animals are infected by pathogenic E. coli, each serotype is more or less specific to a particular animal host.

b. Of the thirty or more serotypes so far identified, a number seem to be associated with particular animal species. There is at present insufficient epidemiological and serological evidence to say whether distinct serotypes are specific to primates.

In summary, the bacterial and viral pathogens listed in Tables 5 and 7 are all passed in the feces of man or animals, they are not free-living, and they normally infect a new host following ingestion. Transmission is therefore primarily by swallowing minute quantities of infected feces (in water, food, and the like) and therefore the sanitary disposal of all feces (both human and animal) and perfect personal hygiene would largely eliminate these infections. Unfortunately, for many of these infections, this has proved an unattainable goal in even the most affluent societies, and more modest targets must be set with the intention of reducing transmission to a manageable level.

2.6 LEPTOSPIRA

Bacteria of the genus Leptospira have been excluded from section 2.5 because they cannot be included in the broad generalizations that have been made. Although, in the majority of human cases, leptospirosis gives rise to a benign, self-limited febrile illness, it occasionally leads to severe, even fatal, diseases characterized by jaundice and hemorrhages, Weil's syndrome. Death may result from kidney failure. The organisms are excreted in the urine of animal carriers and usually infect new animal hosts and man through abraded skin or when the mucous membranes are contaminated with infected urine. Man may be an intermittent urinary shedder for a few weeks, rarely months, after acute infection. Leptospirosis should be considered in relation to excreta because of the risk to workers who handle excrement that may contain leptospire derived either from animal carriers (e.g., the sewer rat, Rattus norvegicus) attracted to such environments or, occasionally, from infected human urine.

2.7 PROTOZOA IN EXCRETA

Many species of protozoa can infect man and cause disease. Among these, several species are harbored in the intestinal tract of man and other animals and may cause diarrhea or dysentery. Infective forms of these protozoa, often as cysts, are passed in the feces and man is infected when he ingests them. Only three species of human intestinal protozoa are considered frequently pathogenic: Giardia, Balantidium, and Entamoeba histolytica (Table 8). With all three, an asymptomatic carrier state is common and, in the case of Entamoeba histolytica, it is these carriers who are primarily responsible for continued transmission.

Table 8: Protozoal Pathogens Excreted in Feces

Protozoa	Disease	Symptomless human carrier state?	Reservoir
<u>Entamoeba histolytica</u>	Colonic ulceration, amoebic dysentery, and liver abscess	Yes	Man
<u>Giardia lamblia</u>	Diarrhea and malabsorption	Yes	Man
<u>Balantidium coli</u>	Mild diarrhea and colonic ulceration	Yes	Man and animals

2.8 HELMINTHS IN EXCRETA

Many species of parasitic worms, or helminths, may infect man. Some can give rise to a range of serious illnesses, but a number appear to cause few symptoms. We are here concerned only with those helminths whose eggs or larval forms are passed out in the excreta -- in the urine for Schistosoma haematobium, the cause of urinary schistosomiasis, and in the feces for all the others under consideration. The helminths that escape through a blister on the skin (guinea worm) or by the bite of a blood-feeding insect are not considered in this section. The blood-borne larvae of the filarial worm causing elephantiasis may be transmitted by Culex pipiens, a mosquito that often breeds in sewage, sullage, and other polluted waters, and Culex-transmitted filariasis is discussed at appropriate points in this report.

Helminths (except for Strongyloides) do not multiply within the human host. If a person is exposed to twenty-three hookworm larvae, for instance, he may subsequently have up to twenty-three hookworms, but cannot have more unless he is reexposed to infection. Therefore, helminth infections need to be thought of quantitatively, with people having heavy or light infections. This contrasts with infections caused by viruses, bacteria, and protozoa, where massive asexual reproduction occurs. In helminth infections, the chance of serious illness is related to the size of worm burden.

Therefore, the development of pathology and the diseased state in helminthic infections is usually the result of a cumulation of worm burdens, often over many years, resulting from regular and repeated reinfections. Asexually replicating organisms, on the other hand, can give rise to an overwhelmingly heavy infection and a state of gross disease within a few days or a few weeks of a single infective dose or organisms entering the body.

The excreted helminths are listed in Table 9. Often the developmental stages through which they pass before reaching man again, their life cycles, may be very complex, as is also shown in the Table. The helminths divide into two main groups: the roundworms (nematodes) and those flat in cross-section. The flat worms again form two groups: the tapeworms (cestodes), which form chains of helminth segments, and the flukes (trematodes), which have a single, flat, unsegmented body. Adult tapeworms mainly create problems by depriving the person they infect of nutrients. The roundworms may cause mechanical obstruction (Ascaris), rectal prolapse (Trichuris), itching around the anus (Enterobius), or anemia (hookworms), in addition to diverting food to themselves and producing abdominal pain in some victims, while many remain symptomless. Among the trematodes, some live in and damage the liver (Clonorchis) or lungs (Paragonimus), while the schistosomes live outside the intestine in small blood vessels and the eggs that fail to escape from the host may damage several organs. The intestinal flukes may occur in large numbers and are mostly transmitted through food items, but they seem to cause relatively mild symptoms.

Most of the roundworms infecting man, and also the schistosomes from among the flukes, have the sexes separate, so that transmission depends upon persons being infected with both male and female worms and upon the mating of these worms within the human body, so that eggs or larvae can be produced and leave the body. This implies that a number of individuals may have unisexual infections, or infections with unmated worms, but be of no significance epidemiologically because they are unable to transmit the infection.

Table 9: Helminthic Pathogens Excreted in Feces

Disease	Common name of pathogen	Pathogen	Transmission	Distribution
Ascariasis	Roundworm	<u>Ascaris lumbricoides</u>	Man--soil--man	Worldwide
Clonorchiasis	Chinese liver fluke	<u>Clonorchis sinensis</u>	Animal or man--aquatic snail--fish--man	S.E. Asia
Opisthorchiasis	Cat liver fluke	<u>Opisthorchis felineus</u> <u>O. viverrini</u>	Animal--aquatic snail--fish--man	U.S.S.R., Thailand
Diphyllobothriasis	Fish tapeworm	<u>Diphyllobothrium latum</u>	Man or animal--copepod--fish--man	Widely distributed foci, mainly in temperate regions
Enterobiasis	Pinworm	<u>Enterobius vermicularis</u>	Man--man	Worldwide
Fascioliasis	Sheep liver fluke	<u>Fasciola hepatica</u>	Sheep--aquatic snail--aquatic vegetation--man	Worldwide in sheep and cattle raising areas
Fasciolopsiasis	Giant intestinal fluke	<u>Fasciolopsis buski</u>	Man or pig--aquatic snail--aquatic vegetation--man	S.E. Asia, mainly China
Gastrodiscoidiasis	--	<u>Gastrodiscoides hominis</u>	Pig--aquatic snail--aquatic vegetation--man	India, Bangladesh, Vietnam, Philippines
Heterophyiasis	--	<u>Heterophyes heterophyes</u>	Dog or cat--brackish water snail--brackish water fish--man	Middle East, southern Europe, Asia
Hookworm	Hookworm	<u>Ancylostoma duodenale</u> , <u>Necator americanus</u>	Man--soil--man	Mainly in warm, wet climates

Table 9 (continued)

Disease	Common name of pathogen	Pathogen	Transmission	Distribution
Hymenolepiasis	Dwarf tapeworm	<u>Hymenolepis</u> spp.	Man or rodent-- man	Worldwide
Metagonimiasis		<u>Metagonimus</u> <u>yokogawai</u>	Dog or cat-- aquatic snail-- freshwater fish-- man	Japan, Korea, China, Taiwan, Siberia
Paragonimiasis	Lung fluke	<u>Paragonimus</u> <u>westermani</u>	Pig, man, dog, cat or other animal--aquatic snail--crab or crayfish--man	S.E. Asia; scattered foci in Africa and S. America
Schistosomiasis; bilharziasis	Schistosome; bilharzia	<u>Schistosoma</u> <u>haematobium</u>	Man--aquatic snail--man	Africa, Middle East, India
		<u>S. mansoni</u>	Man--aquatic snail--man	Africa, Arabia, Latin America
		<u>S. japonicum</u>	Animals and man-- snail-- man	S.E. Asia
Strongyloidiasis	Threadworm	<u>Strongyloides</u> <u>stercoralis</u>	Man--man (dog--man?)	Mainly in warm, wet climates
Taeniasis	Beef tapeworm;	<u>Taenia saginata</u>	Man--cow--man	Worldwide
	pork tapeworm	<u>T. solium</u>	Man--pig--man, or man--man	Worldwide
Trichuriasis	Whipworm	<u>Trichuris</u> <u>trichiura</u>	Man--soil--man	Worldwide

2.9 THE HAZARD FROM FECES

From the above discussion the nature of the hazard from excreta is becoming clear. Feces not only smell and are considered offensive in most societies, but they may contain an array of pathogenic viruses, bacteria, protozoa, and helminths that may cause disease in a new host. Feces are, therefore, the beginning of the transmission routes of the diseases that we are considering in this book and the aim of improving excreta disposal facilities is to interrupt these routes at their very inception.

We can dramatize the magnitude of the potential hazard by considering the typical load of pathogens that a poor, tropical community may be excreting in a single day. Table 10 presents these data for only the more prominent diseases of considerable public health importance. Table 10 emphasizes the point that every community in the world is producing every day a large volume of feces and fecal products, often containing significant concentrations of pathogenic organisms. The resulting diseases comprise some 10 to 25 percent of the illness that comes to the attention of the health care services as well as causing a vast amount of misery that does not. It is the responsibility of the engineering profession and the relevant government agencies to collect, transport, treat, and reuse these substances in a way that does not endanger the public health.

2.10 PATHOGENS IN URINE

Generally speaking, urine is a sterile and harmless substance. There are occasions, however, when infections in the host will cause pathogens to be passed in the urine. The three principal infections that will lead to pathogens appearing in significant numbers in the urine are urinary schistosomiasis (caused by Schistosoma haematobium), typhoid, and leptospirosis.

In cystitis and other urinary infections coliform and other bacteria may be numerous in the urine, but they are no risk to others. In venereal infections, also, the microbial agents will reach the urine, but they are so vulnerable to conditions outside the body that excreta are unimportant as a vehicle of transmission.

Table 10: Possible Output of Some Pathogens in the Feces and Sewage of a Tropical Community a/

Pathogen	Typical prevalence of infection in developing country <u>b/</u> (percent)	Typical average number of organisms per gram of feces <u>c/</u>	Total number excreted per infected person per day <u>d/</u>	Total number excreted per day in town of 50,000 pop.	Concentration per liter in sewage from town of 50,000 <u>e/</u>
Enteric viruses	5	10^6	10^8	2.5×10^{11}	5,000
<u>Salmonellae</u>	7	10^6	10^8	3.5×10^{11}	7,000
<u>Shigellae</u>	7	10^6	10^8	3.5×10^{11}	7,000
<u>Vibrio cholerae</u>	1	10^6	10^8	5×10^{11}	1,000
Pathogenic <u>E. coli</u>	?	10^8	10^{10}	?	?
<u>Entamoeba histolytica</u>	30	15×10^4	15×10^6	2.25×10^{11}	4,500
<u>Ascaris</u>	60	10,000 <u>e/</u>	10^6	3×10^{10}	600
<u>Trichuris</u>	60	2,000 <u>e/</u>	2×10^5	6×10^9	120
Hookworms	40	800 <u>e/</u>	8×10^4	1.6×10^9	32
<u>Schistosoma mansoni</u>	25	40 <u>e/</u>	4×10^3	5×10^7	1
<u>Taenia saginata</u>	1	10^4	10^6	5×10^8	10

a. This table represents an entirely hypothetical situation and the figures are not taken from any single town. For each pathogen, however, the figures are reasonable and in line with those found in the literature. The concentrations of each pathogen in sewage, derived in the table, are in line with the higher figures in the literature. It is, however, unlikely that all these infections at these relatively high prevalences would occur in any one community.

b. The prevalence figures quoted in this column refer to infection and not to morbidity.

c. It must be remembered that the pathogens listed have different abilities to survive outside the host and the concentration of some of them will rapidly decline after the feces have been passed. Calculations are made assuming 100 liters per capita per day of sewage produced, and that 90 percent of excreted pathogens do not enter the sewers or are inactivated in the first few minutes.

d. To calculate this figure it is necessary to estimate a mean fecal weight for those people infected. This must necessarily be the roughest estimate because it depends on the age-specific fecal weights in the community and the age distribution of infected people. It was assumed that over-fifteen-year-olds excrete 150 grams per day and that under-fifteen's excrete, on average, 75 grams per day. It was also assumed that two-thirds of all infected people are under fifteen. This gives a mean fecal weight for infected individuals of 100 grams.

e. The distribution of egg output among people infected by these helminths is extremely skewed and some people are putting out very high egg concentrations.

People infected with urinary schistosomiasis (due to Schistosoma haematobium) will pass ova chiefly in their urine. The worms live for years, occasionally decades, and superinfection is possible, so that those affected will often pass eggs, sometimes accompanied by blood, for much of their lifetime. Ten milliliters of urine may contain over a thousand eggs in heavy infections if the urine is collected near midday, when eggs are most numerous.

During the phase of typhoid and paratyphoid fevers when bacteria are disseminated through the blood, the organisms will usually be shed in the urine. In a few cases where S. haematobium is also present, prolonged urinary carriage of typhoid may occur over many years.

An individual with leptospirosis will pass Leptospira intermittently in his urine for a period of about four to six weeks. Chronic carrier states in man are rare.

CHAPTER 3

THE NATURE OF SULLAGE

3.1 INTRODUCTION

Sullage, also known as graywater, is domestic wastewater not containing excreta. It is the wastewater from baths, sinks, and the like, which may be expected to contain considerably fewer pathogenic microorganisms than sewage. Interest and research in the handling of sullage has increased in recent years in both developing and affluent countries. In affluent countries there is growing interest in the use of sewerless chemical toilets and the separate disposal of sullage as a way to overcome the environmental problems associated with the disposal of large volumes of heavily contaminated sewage from urban areas. There is also interest in chemical toilets and on-site sullage disposal for developments in nature parks where environmental considerations are paramount (Winneberger, 1974).

In developing countries, also, there is growing realization of the financial and other difficulties associated with the provision of water-borne sewerage and thus a growing interest in dry or on-site techniques such as composting toilets or cartage systems (Rybczynski, Polprasert, and McGarry, 1978). These sewerless technologies require that separate provision be made for the disposal of sullage when the volumes of domestic wastewater become too great just to drain away in the yard. It is increasingly realized everywhere that it is too expensive to use up to half of the high quality drinking water supply in a house simply to flush excreta along sewers. With the development of any toilet not flushed by water comes the need to design a sullage disposal system.

3.2 QUANTITIES

Volumes of sullage produced depend upon domestic water use. Where people use public taps, domestic water use may be as low as 10 liters per capita daily (White, 1977). In affluent households with full plumbing, water use may be 200 or more liters per capita daily, and all water not used for flushing toilets may be classed as sullage. Bennett, Linstedt, and Felton (1974), studying homes in the U.S.A., found that the toilet was used 3.6 times per capita daily, that the average flush was 15.5 liters, and that toilet flushing accounted for 33 percent of domestic water use. Witt, Siegrist, and Boyle (1974), also studying homes in the U.S.A., found corresponding figures of 2.3 times per capita daily, 15.1 liters, and 22 percent. Reviewing data from several studies, Witt, Siegrist, and Boyle (1974) found that toilet flushing water comprised between 22 percent and 45 percent of total domestic water usage. Laak (1974) reviewed data from Canada, Sweden, and the U.S.A. that shows the following allocation of water use in houses with full plumbing fixtures.

<u>Facility</u>	<u>Mean</u> (percent)	<u>Range</u> (percent)
Kitchen	9	5-16
Bathroom	26	12-40
Laundry	18	4-22
Toilet flushing	47	41-65

We have been unable to obtain comparable figures from urban households in developing countries either with or without sewer connections. There are data for rural households without sewers, however, and examples from Lesotho (Feachem *et al.*, 1978), Papua New Guinea (Feachem, 1977) and Uganda (White, Bradley, and White, 1972) are given in Table 11.

Table 11. Water Use in Sewerless Rural Households in Selected Developing Countries

Water use	Country			
	Lesotho	Papua New Guinea (Enga)	Uganda	
			Lango	Kigezi
Drinking (humans)) 45.3%	79.0% <u>a/</u>	19%	6% <u>a/</u>
"Kitchen" (cooking and utensil hygiene))	11.0%	13%	74%
Drinking (animals)	2.4%	7.5%	0%	0%
"Bathroom" (personal hygiene)	15.0%	0%) 66%) 20%
Laundry	22.0%	0%))
Vegetable gardens	5.6%	0%	0%	0%
Other	9.7%	2.5%	2%	0%
Total water use per capita daily	18.0 liters	0.68 liters	18 liters	8 liters

a. These are very small volumes of drinking water. In Papua New Guinea they may be due to features of physiology, such as very low salt intake and a consequently low need for fluids, and also to water intake from food, especially sugar cane (see Feachem, 1977). In Kigezi, the small volumes of drinking water are caused by the practice of eating gruels and other very liquid foods.

These figures highlight the immense differences of water use practice, and thus in type of sillage produced, according to culture, environment, wealth, and many other factors.

The health implications of sillage disposal will depend on the technology employed, which in turn will depend primarily on the volume of sillage per household, the density of housing, the nature of the climate, soil type, and groundwater conditions.

3.3 CHARACTERISTICS OF SULLAGE

Table 12 (from Laak, 1974) presents the results of surveys on five households in the U.S.A. The sullage contributed 53 percent of the sewage flow, 52 percent of the BOD₅, 43 percent of the COD, about 15 percent of the nitrogen and 45 percent of the phosphates. Table 12 indicates that, using the ratio of COD to BOD₅ as the criterion, the wastes from the toilet are more resistant to biodegradation than the sullage. Hypes (1974) points out the effect of sink-installed garbage disposal units on the quality of sullage. In his test, sullage without garbage solids had a BOD₅ of 328 milligrams per liter, while with garbage it had, on average, 480 milligrams per liter. In Taipei it was found that sullage contributed 40 percent of BOD₅ in sewage, but it was noted that food scraps were fed to pigs rather than washed down the sewers. (World Health Organization, 1970).

Witt and his colleagues (1974) examined the bacterial content of sullage in the U.S.A. Their results, summarized in Table 13, show that bath and shower waters were less contaminated by fecal bacteria than were waters used for washing clothes. Furthermore, 38 percent of the fecal streptococcal isolates were enterococci (Streptococcus faecalis, S. faecium, and S. durans) and the majority of the bath enterococci were S. faecalis var. liquefaciens, whereas only a few enterococci isolated from the clothes washing waters were of this species. S. faecalis var. liquefaciens is now widely regarded as being of nonfecal origin. S. bovis accounted for 22 percent of all streptococcal isolates. The implications of these findings are that under half of the streptococci isolated were from human feces and the bath waters were even less contaminated relative to the clothes washing waters from the total counts suggested. Hypes (1974) found that the coliform counts in sullage were about 1.9×10^7 per 100 millimeters, irrespective of garbage content. After twenty-four hours of storage, this count had increased to 5.4×10^8 , indicating that sullage is a favorable medium for coliform growth.

Table 12. Pollution Loads of Wastewater as Sampled from Each Plumbing Fixture (milligrams per capita daily)

	BOD		COD		NO ₃ -N		NH ₃ -N		PO ₄	
	Mean	%	Mean	%	Mean	%	Mean	%	Mean	%
Kitchen sink	9,200	19	18,800	16	7.6	10.4	74	2.3	173	1.5
Bathtub	6,180	13	9,080	8	11.6	16.0	43	1.3	30	0.3
Bathroom sink	1,860	4	3,250	2	2.2	3.0	9	0.3	386	3.3
Laundry machine	7,900	16	20,300	17	35.3	48.5	316	9.8	4,790	40.4
Water closet	23,540	48	67,780	57	16.0	22.0	2,782	86.5	6,473	54.5
Total pollution	48,690	100	119,410	100	72.7	100.0	3,224	100.0	11,862	100.0

Source: From Laak (1974).

Table 13. The Bacterial Content of Sullage in the U.S.A.

Type of sullage	Total coliforms per 100 milliliters		Fecal coliforms per 100 milliliters		Fecal streptococci per 100 milliliters	
	Geometric mean	Range	Geometric mean	Range	Geometric mean	Range
Bath and shower water	1,100	70-8.2 x 10 ³	220	1-2.5 x 10 ³	44	1-7 x 10 ⁴
Clothes washing water	18,000	85-8.9 x 10 ⁵	1,400	9-1.6 x 10 ⁴	210	1-1.3 x 10 ⁶
Clothes rinsing water	5,300	190-1.5 x 10 ⁵	320	35-7.1 x 10 ³	75	1-2.3 x 10 ⁵

Source: From Witt, Siegrist, and Boyle (1974).

Unfortunately, these bacterial concentrations are the only sullage microbiological data that we have encountered. It may be assumed that sullage from bathrooms and laundries would contain small numbers of any pathogenic viruses, bacteria, protozoa, and helminths that were being excreted. The washing of babies, and of babies' soiled clothing, might be expected to raise the pathogen content of sullage substantially. It is possible that some bacteria would find sullage at warm temperatures a suitable medium for multiplication. Data on the microbiological quality of sullage from the tropics would help to clarify this picture and should be collected as a research priority.

3.4 HEALTH ASPECTS

There are fundamentally five kinds of sullage disposal systems:

- (a) casual disposal by tipping in the yard;
- (b) garden watering;
- (c) on-site disposal by soakaway;
- (d) drainage in open drains; and
- (e) drainage in covered drains or sewers.

Each of these has different health implications.

Tipping in the yard may create breeding sites for Culex pipiens, which is a major nuisance mosquito and also the vector of bancroftian filariasis in some areas of the world. It may also create muddy and unsanitary conditions in the yard that could help to promote the development of nematode ova, which require a fairly moist environment. A clean, dry yard is less likely to be used for defecation by children, and any ova deposited are unlikely to develop. A wet, muddy yard will conceal any feces deposited and will promote development of worm eggs and larvae.^{1/} Sullage containing pathogens from babies' bath water or adults' ablution water may infect children playing in the yard. In soils with good drainage, where sullage production or housing density are low, tipping of sullage water outside the home is unlikely to be a major health hazard. Where soils are less permeable, however, and where water use or housing density is high, an adequate method of sullage disposal becomes essential. It should be noted that high housing densities are generally associated with poverty and thus with low levels of water use and low volumes of sullage production.

Sullage disposal by watering vegetable gardens near the house is likely to create few if any health hazards, provided that prolonged ponding is prevented (thus discouraging mosquito breeding) and that children are discouraged from defecating in or near the gardens.

1. Some of the classic literature on nematode infections (for instance, Cort, Otto, and Spindler, 1930; Otto and Spindler, 1930; Otto, Cort, and Keller, 1931; and Winfield, 1937) suggests that, among households of similar socioeconomic status, the contamination of the yard by the feces of young children is associated with increased intensity of ascariasis, while a yard that is moist and shady may be associated with increased hookworm infection.

Sullage disposal by soakaway provides a low risk of groundwater contamination. This is discussed in chapter 12, but it is worth noting here that the risk of microbiological groundwater pollution is very much lower with sullage than it is with sewage. The same is true of high nitrate pollution, since we have seen in Table 12 that sullage contains very little nitrogen compared to sewage.

Drainage in open drains, maybe in stormwater drains, provides the most readily identifiable health risk -- that of promoting Culex pipiens and other mosquito breeding. Assume that sullage is being introduced into the stormwater drainage system. In areas of year-round rainfall, these drains will contain water continuously. If they are kept free of garbage and are well designed, they will flow freely and provide few sites for mosquito breeding. The presence or absence of sullage will make no difference. In areas of seasonal rainfall, however, and where the drains are liable to blockage and pondage, the addition of sullage will create year-round water and thus year-round Culex breeding where previously only seasonal Culex breeding may have occurred. Thus, it is not the quality of the sullage that is important, since ponded stormwater will also be sufficiently polluted to allow Culex pipiens breeding. The continuous production of sullage may convert wet season breeding into year-round breeding in areas where the stormwater drains are liable to pond. This rise in Culex populations may lead to increased filariasis transmission, heavier infections, and more disease.

An example of this latter effect is provided by the recent resurgence of bancroftian filariasis as a major public health problem in Egypt. Since approximately 1965 a complex of factors, including major changes in irrigation practice, a proliferation of poorly maintained water supplies, and inadequate excreta disposal facilities leading to the contamination of surface water, have increased Culex population, which has led in turn to a dramatic increase in the prevalence and intensity of bancroftian filariasis and to an extension in the geographical spread of the infection. It has also led to an explosive epidemic of Rift Valley Fever from October 1977 to the present day.

A similar effect could be caused in urban areas by large scale sullage disposal in open drains with a tendency to blockage. Too often sullage makes its way to streams by natural gullies, and no formally defined drainage system exists. The solution to these problems is either to use an alternative method of sullage disposal or to protect drains from blocking by covering or by vigorous efforts to keep them clear. The latter approach is the more realistic and can be implemented either by the employment of municipal workers, by subcontracting the job to the private sector, or by organizing and motivating community effort on a neighborhood basis.

Finally, sullage may be disposed of in a sewerage system, as with sewage except that smaller bore pipes may be used. This raises no special health problems and conventional treatment before discharge or reuse should be highly effective. The load of pathogenic microorganisms will be small, so that discharge or reuse can take place without tertiary treatment.

CHAPTER 4

ENVIRONMENTAL CLASSIFICATION OF EXCRETA-RELATED INFECTIONS

4.1 INTRODUCTION

In chapter 2 we showed the variety and number of diseases related to excreta. In considering improved excreta disposal technologies, the engineer, administrator, and community development worker cannot consider each disease separately. Rather, they require a conceptual framework that links various types of excreta-related infections to the design and implementation of particular disposal or reuse technologies. A biological classification, which groups the viruses, bacteria, protozoa, and worms together, may be less helpful in understanding the health aspects of alternative approaches to excreta disposal than a classification of infections that is based upon their transmission routes and life cycles. Such a classification we call an environmental classification. In fact, the resemblance between a biological and an environmental classification is much closer in the case of the excreta-related infections than in the case of the diseases related to water.

The purpose of an environmental classification is to group infections in such a way that the role of different preventive measures and the efficacy of different environmental and behavioral modifications are made clear. An environmental classification for the "water-related infections" has already been proposed (Bradley, 1977; Feachem, McGarry, and Mara, 1977). The object here is to propose an environmental classification of the infections related to excreta. In devising such a classification we have encountered two major limitations. The first is, remarkably, how little is known about the transmission of several infections and the numbers of microbes needed to pass the infections on to susceptible people. The second is that the bulk of the excreted viruses, bacteria, and protozoa differ quantitatively rather than qualitatively in their transmission characteristics and it is easy to finish up with a big category containing the majority of infections. Understanding of these infections depends on some basic parameters of transmission, especially latency and persistence in the environment, and the infective dose for man. We therefore discuss these and other key concepts before setting out the classification.

4.2 KEY CONCEPTS IN UNDERSTANDING EXCRETA-RELATED INFECTIONS

Excreta may be related to human disease in two ways (Figure 1). The agents of many important infections, set out in chapter 2, escape from the body in the excreta and thence eventually reach others. These are the excreted infections. In some cases the reservoir of infection is almost entirely in animals other than man. These are not dealt with here because such infections cannot be controlled through changes in human excreta disposal practices. We do include, however, a number of infections for which both man and other animals serve as a reservoir.

The second way in which excreta relate to human disease is where their disposal encourages the breeding of insects. These insects may be a nuisance in themselves (flies, cockroaches, mosquitoes), they may mechanically transmit excreted pathogens either on their bodies or in their intestinal tracts (cockroaches and flies), or they may be vectors for pathogens that

circulate in the blood (mosquitoes). Where flies or cockroaches are acting as vehicles for the transmission of excreted pathogens, this represents a particular case of the many ways in which excreted pathogens may pass from anus to mouth. Where mosquitoes are transmitting nonexcreted pathogens, however, the concepts discussed in this chapter have little relevance and the important factors are those that determine the breeding habits of the particular mosquitoes.

Figure 1 — Main Ways of Excreta's Relation to Ill Health

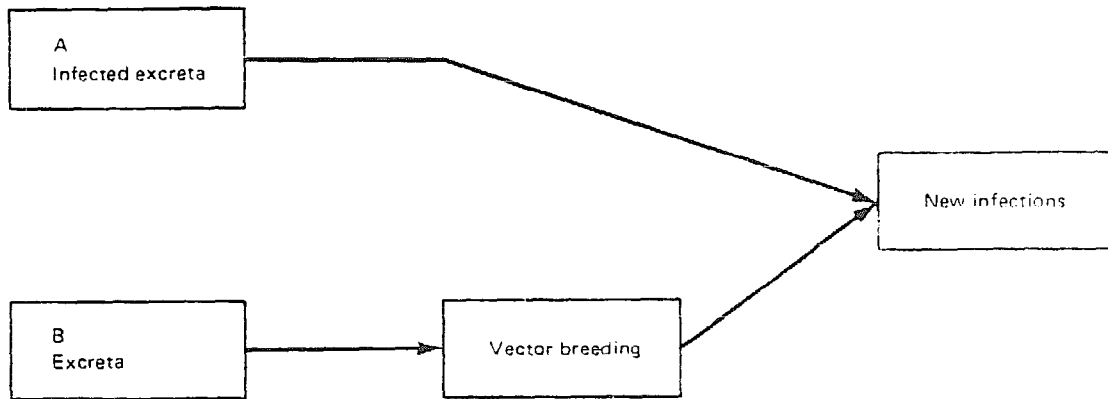

Note: In A the excreta itself contains the pathogens which may be transmitted by various routes to a new host. In B the excreta or sewage permits the breeding of certain flies and mosquitoes that may act as vectors of excreted and other pathogens.

In considering the transmission of excreted infections, the distinction between the state of being infected and the state of being ill must be kept in mind. Very often, the most important section of the population involved in transmitting an infection shows little or no sign of disease; conversely, individuals with advanced states of disease may be of little or no importance in transmission. A good example occurs in schistosomiasis, where as much as 50 percent of the total egg output in feces and urine reaching water from a human population may be produced by children in the five-to-fifteen year age group; many of these children will show minimal signs of disease. Conversely, middle-aged people with terminal disease conditions may produce few or no hatchable eggs.

If an excreted infection is to spread, an infective dose of the relevant agent has to pass from the excreta of a case, carrier, or reservoir of infection to the mouth of a susceptible person or some other portal of entry. Spread will depend upon the numbers of pathogens excreted, upon how these numbers change during the particular transmission route or life cycle, and upon the dose required to infect a new individual. Infective dose is in turn related to the susceptibility of the new host. Three new factors govern the probability that, for a given transmission route, the excreted pathogens from one host will form an infective dose for another. These are latency, persistence, and multiplication. Diagrammatically we can represent the concepts thus:

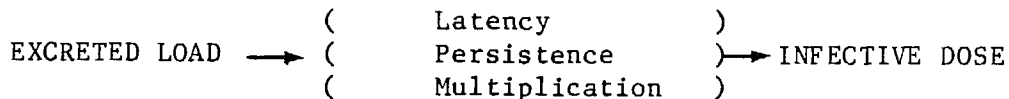

We will discuss these concepts in turn.

Excreted load. There is wide variation in the concentration of pathogens passed by an infected person. For instance, a person infected by a small number of nematode worms may be passing a few eggs per gram of feces, whereas a cholera carrier may be excreting more than 10^6 vibrios per gram, and a case may pass 10^{13} vibrios in a day.

Where large numbers of organisms are being passed in the feces, they can give rise to high concentrations in sewage (see Table 10). Thus, even in England, where water use is relatively high and salmonellosis relatively rare, raw sewage may contain 10^4 Salmonella per liter. At these concentrations, removal efficiencies of 99 percent in treatment works will still leave 10^2 pathogenic organisms per liter in the effluent, and their implications for health will depend upon the disposal method, their ability to survive or multiply, and the infective dose required.

Latency. By latency we mean the interval between the excretion of a pathogen and its becoming infective to a new host. Some organisms, including all excreted viruses, bacteria, and protozoa have no latent period and are immediately infectious when the excreta are passed. The requirements for the safe disposal of excreta containing these agents are different from those for helminthic infections, where there is a prolonged latent period.

In particular, infections that have a considerable latent period are largely risk-free where night soil is being carted, whereas the others constitute a major health hazard in fresh night soil. Therefore, in our classification the first two categories, where no latency is observed, are separated from the remaining categories, where a definite latent period occurs.

Among the helminthic infections (Table 9), only three have eggs or larvae that may be immediately infectious to man when passed in the feces. These are the pinworm or threadworm (Enterobius vermicularis), a dwarf tapeworm (Hymenolepis nana), and sometimes Strongyloides stercoralis. The remaining excreted helminths all have a distinct latent period, either because the eggs must develop into an infectious stage in the physical environment outside the body or because the parasite has one or more intermediate hosts through which it must pass to complete its life cycle.

Persistence (survival) of the pathogen in the environment is a measure of how quickly it dies after it leaves the human body. It is the single property most indicative of the fecal hazard, in that a very persistent pathogen will create a risk throughout most treatment processes and during the reuse of excreta.

A pathogen that persists outside the body only for a short time needs to find a new susceptible host rapidly. Hence transmission cannot follow a long route through sewage works and the final effluent disposal site back to man, but will occur in the family by transfer from one member to another as a consequence of poor personal cleanliness. More persistent organisms can readily give rise to new cases of disease further afield, and as persistence increases so also must concern for the ultimate disposal of excreta. In addition, pathogens that tend to persist in the general environment will require more elaborate processes if they are to be inactivated in a sewage works. Methods of sequestering them, as by sedimentation into a sludge that receives special treatment, are often needed.

To measure persistence or viability of pathogenic organisms in a laboratory is easy. The results, however, need confirmation by field studies of persistence, which are more difficult. In order to interpret such results it is necessary to know how many are being shed in the excreta (relatively easy to determine) and the infective doses for man (extremely difficult).

Multiplication. Under some conditions certain pathogens will multiply in the environment. Thus, originally low numbers can be multiplied to produce a potentially infective dose (see below). Multiplication can take the form of reproduction by bacteria in a favored substrate (e.g., Salmonella on food) or of the multiplication by trematode worms in their molluscan intermediate hosts.

The former case is a mechanism whereby light fecal contamination may build up bacterial numbers to reach the apparently high minimal infective doses needed by many excreted bacterial pathogens. The need for this may determine the usual mode of infection, since multiplication in water is rare and limited compared with the massive increases possible in food. Viruses and excreted protozoa do not multiply outside their animal hosts.

Among the helminths transmitted by excreta, all the trematodes infecting man undergo multiplication in aquatic snails. This introduces a prolonged latent period of a month or more while development is taking place in the snail, followed by an output of up to several thousand larvae into the environment for each egg that reaches a snail. Category V of the classification is used for infections of this sort where excreta have to gain access to the appropriate snail habitat, but once this happens great amplification is possible.

Infective Dose. In a tidy world, knowledge of the output of pathogens in the excreta of those infected, the mean infective dose, and the extractive efficiency of the excreta treatment process, would make risk assessment a simple calculation. The real world is much less predictable than this because of the variable infective dose of most pathogens and the uneven distribution of infection in the environment. While the minimal infective dose for some diseases may be a single organism, or very few, the doses required in most bacterial infections are much higher. Data on this are very hard to acquire, since they involve administering a known dose of a pathogen to a volunteer. Information is scanty, concerned with doses required to infect, say, half those exposed, rather than a minute proportion, at a single exposure. The volunteers have been well-nourished adults and usually from nonendemic areas. Such results have therefore to be applied with great caution to malnourished peasant children continually exposed to infection. It has been found that changes in the manner of administration, such as preceding a dose of cholera vibrios with an alkaline substance to reduce temporarily free gastric acid, may lower the mean infective dose of such organisms by a factor of 10^3 . Also, in human experimental studies the infective dose for half the people exposed (known as the ID_{50}) is the most reliable result, but in natural transmission the dose that is infective for 5 percent or less of the population may be more relevant.

The consequent uncertainties over the size of the minimal infective dose in nature makes it a difficult criterion to use in devising a classification, but it is so important that it cannot be left out. The difficulties are greatest for the major excreted bacterial infections and for protozoa. For viruses there is evidence of low infective doses in experiments, and in human populations for some but not all virus infections.^{1/} Among the helminths a single egg or larva can infect if ingested, even though a high proportion of worms can fail to develop to maturity, especially where immunity is present.

1. The WHO Scientific Group on Viruses in Water, Wastewater, and Soil, which met in Geneva in October 1978, concluded that one or a few infectious units of virus can cause infection in a certain proportion of the nonimmune individuals who ingest them in drinking water.

Host response. Host response is important in determining the result of an individual receiving a given dose of an infectious agent. In particular, acquired immunity and the relation of age to pathology are important for predicting the effects of sanitation. At one extreme would be a shortlived parasite to which little immunity developed and in which the relation between infection and disease was not age-dependent. Then a close, tending to linear, relationship between exposure and disease might be expected, with improvements in the appropriate aspects of sanitation giving health benefits proportional to effort. Ascaris closely approximates this model.

At the other extreme would be a viral or bacterial infection that gives rise to long-lasting immunity and where the chance of overt disease in those infected rose with increasing age. An example is infection with poliomyelitis virus (Table 5). Under very bad sanitary conditions all are infected at a young age, older children and adults are immune, and disease is limited to a few of the youngest children who may suffer chronic paralysis. If sanitation improves, infection is deferred and its pathological consequences later in life are more serious. Thus, although poliovirus transmission may be reduced by improving sanitation, it will not necessarily result in reduction in disease, which in practice is achieved by immunization. This may apply to other excreted infections, such as infectious (viral) hepatitis, and it has been argued in the case of typhoid. There are probably several infections, however, where human immunity is of importance in regulating the amount of disease. This will tend to reduce the health significance of moderate sanitary improvements, and may in part explain the disappointing impact of some sanitary programs (see chapter 5 and appendix II).

The balance between exposure to infection and host response to it will determine the pattern of excreta-related disease. If transmission, creating exposure to a particular infection, is low, then most people will not have encountered the infection. They will be susceptible. If a sudden increase in transmission of the disease occurs, it will affect all age groups in epidemic form. Improvements in sanitation will have a big effect under these circumstances by reducing the likelihood and/or the magnitude of an epidemic.

By contrast, if transmission is very high all the people will be repeatedly exposed to infection and first acquire it in childhood. Subsequent exposures may be without effect if immunity is acquired from the first attack. Or immunity may be cumulative from a series of attacks. The infection will always be present and is described as endemic. Under these conditions much transmission is ineffective because of human acquired immunity, and reduced transmission, as through improved sanitation, will only delay the date of infection somewhat so that older children are infected. Very large improvements in sanitation will either render the infection very rare or, if the disease was originally very highly transmitted, make it an adult disease. Examples are typhoid, which can be completely prevented in the community by adequate management of excreta and of water supplies, and poliomyelitis virus infection, which can be prevented only by taking extreme hygienic precautions. In practice, improved sanitation increases the disease problem by deferring infection to an age at which the clinical course is more severe.

Consequences of a juvenile-age prevalence are that not only do children suffer chiefly from the diseases, but they are also the main sources of infection, so that the acute need for better community excreta disposal is focussed on young children, the group perhaps least inclined to use any facilities that may be available.

Other hosts besides man. Some excreted infections are strictly confined to human beings, for example, shigellosis, and the control of human excreta alone is required for their prevention. Many others involve wild or domestic vertebrate animals as well as man, and such infections are called zoonoses (for example, salmonellosis).

There are two groups of zoonoses, which have quite different implications for sanitation (Figure 2). In the first case the animals act as alternatives to man as the hosts of the infection. Thus, even if human excreta is under completely safe control, the excreta of the other animals can continue to transmit the infection. In effect, the animal is "in parallel" with man. It is necessary to control both human and animal excreta or tackle the problem in some other way. In the other situation the vertebrate animal is an essential step in the transmission of the disease from one person to another (Figure 2, "in series"). Here control of either human excreta or of the infection in the animals alone will suffice to end transmission. In our classification below, we have therefore separated the second group from the others, and it includes the human tapeworms of the genus Taenia.

Some excreted helminthic infections have invertebrate intermediate hosts (Table 9). They will therefore be controlled if:

- (a) excreta are prevented from reaching the intermediate host;
- (b) the intermediate hosts are controlled; and
- (c) people do not eat the intermediate host uncooked or do not have contact with the water in which the intermediate host lives (depending on the particular life cycle).

Some details on the factors discussed above are provided in Table 14 for the excreted infections being considered.

Figure 2 — Involvement of Other Vertebrates in Transmission of Human Excreted Infections

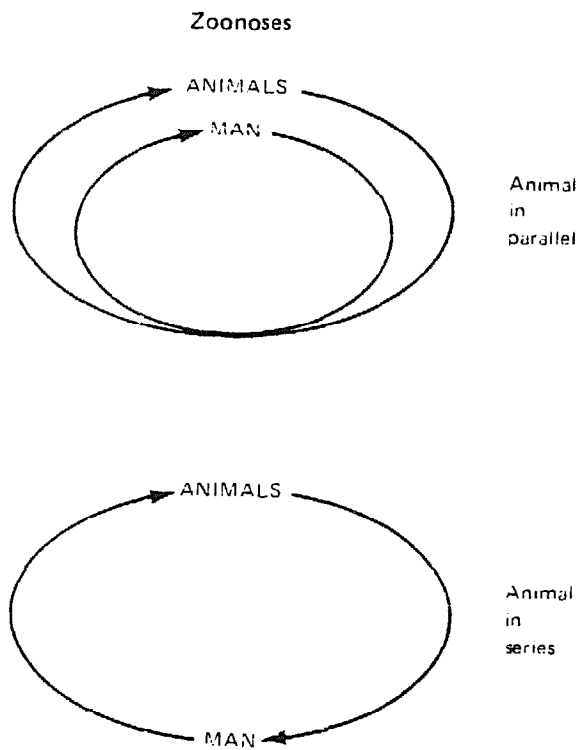

Note. Examples of zoonoses in parallel are salmonellosis and balantidiasis. Examples of zoonoses in series are beef- and pork-tapeworm infections.

4.3 ENVIRONMENTAL CLASSIFICATION OF EXCRETA-RELATED INFECTIONS

There are many ways in which the excreted infections could be grouped on the basis of the information presented in Table 14. We have searched for a classification that is most relevant to the effect of excreta disposal per se and that is most helpful in considering the impact of changing excreta disposal facilities and technology. Table 15 presents this classification. We have distinguished six categories of infection. The environmental factors considered here are latency, persistence, multiplication, transmission, and immunity.

There is a clear difference between the first five categories of excreted pathogens and the last, which contains the excreta-breeding insect vectors of disease. A variety of sanitation methods will control the insects and there are additional specific measures that can be directed against them.

The excreted infections are divided on the presence (categories III-V) or absence (I and II) of a latent period so that health problems with fresh feces or night soil are particularly acute in the first two categories. The distinction between categories I and II, on the one hand, and categories III-V, on the other, is fundamental and clear cut. It also corresponds closely to the biology of the pathogens, in that all infections in categories III-V are helminthic.

Table 14. Some Basic Features of Excreted Infections a/

Category (Table 15)	Pathogen	Latency (typical min. time from excretion to infectivity)	Persistence anticipated max. life of infective stage at 20-30°C	Concen- tration (typical average number of orga- nisms per gram of feces)	Multipli- cation outside human host	Median infective dose (High >10 ⁶ Medium 10 ⁴ Low <10 ²)	Signi- ficant Immunity?	Major reser- voir other man?	Inter- mediate host?
I	Enteric viruses	0	6 months	10 ⁶	No	Low	Yes	No	None
	Hepatitis A virus	0	7 months	10 ⁶ (?)	No	Low	Yes	No	None
	Rotaviruses	0	1 year (?)	10 ⁶ (?)	No	Low	Yes (?)	No	None
	<u>Entamoeba histolytica</u>	0	20 days	15 x 10 ⁴	No	Low	No	No	None
	<u>Giardia lamblia</u>	0	3 months	10 ⁵	No	Low	No (?)	No	None
	<u>Balantidium coli</u>	0	1 month (?)	?	No	Low (?)	No	Yes	None
	<u>Enterobius</u>	0	7 days	Not usually found in feces	No	Low	No	No	None
	<u>Hymenolepis</u>	0	A few weeks	?	No	Low	Yes (?)	No	None
II	<u>Salmonella typhi</u>	0	60 days	10 ⁶	Yes (food)	High	Yes	No	None
	Other salmonellae	0	1 year	10 ⁶	Yes (food)	High	Irrelevant <u>b/</u>	Yes	None
	<u>Shigella</u>	0	40 days	10 ⁶	Yes (food)	Medium	No	No	None
	<u>Vibrio cholerae</u>	0	30 days	10 ⁶	Unlikely	High	Limited	No	None
	Path. <u>E. coli</u>	0	1 year	10 ⁸	Yes	High	Yes (?)	No	None
	<u>Yersinia</u>	0	6 months	10 ⁵	Yes (food)	High	No	Yes	None
	<u>Campylobacter</u>	0	?	?	?	?	?	?	None
III	<u>Ascaris</u>	9 days	several years	10 ⁴	No	Low	No	No	None
	<u>Trichuris</u>	3 weeks	1-1/2 years	10 ³	No	Low	No	No	None
	Hookworms	7 days	20 weeks	8 x 10 ²	No	Low	No	No	None
	<u>Strongyloides</u>	3 days	5 weeks (free living stage very much longer)	10	Yes	Low	Yes	No	None
IV	<u>Taenia</u>	8 weeks <u>c/</u> 2 years	10 ⁴	No	Low	No	No	Cow/pig	

(Table continues on following page).

Table 14 (continued)

Category (Table 15)	Pathogen	Latency (typical min. time from excretion to infectivity)	Persistence (anticipated max. life of infective stage at 20-30°C)	Concen- tration (typical average number of orga- nisms per gram of feces)	Multipli- cation outside human host	Median infective dose (High >10 ⁶ Medium 10 ⁴ Low <10 ²)	Signi- ficant immunity?	Major reser- voir other than man?	Inter- mediate host?
V f/	<u>Clonorchis</u>	3 months d/	Life of fish	10 ²	Yes e/	Low	No	No	Snail & fish
	<u>Diphylloboth- rium</u>	4 weeks d/	Life of fish	10 ⁴	No	Low	No	Yes	Copepod & fish
	<u>Fasciolopsis</u>	10 weeks c/	?	10 ²	Yes e/	Low	No	Yes	Snail & aquatic plant
	<u>Paragonimus</u>	4 months d/	Life of crab	?	Yes e/	Low	No	Yes	Snail & crab or cray- fish
	<u>Schistosoma mansoni</u>	4 weeks c/	2 days	40	Yes e/	Low	?	No	Snail
	<u>Schistosoma haematobium</u>	5 weeks c/	2 days	40/10 ml urine	Yes e/	Low	Yes	No	Snail
	<u>Schistosoma japonicum</u>	7 weeks c/	2 days	40	Yes e/	Low	Yes	Yes	Snail

Notes: a. Leptospirosis does not fit into any of the categories defined in Table 14.

Leptospira 0 7 days ? (urine) No Low Yes Yes None.

b. The large number of serotypes (>1,000) makes immunity epidemiologically irrelevant.

c. Life cycle involves intermediate host. Latency is minimum time from excretion by man to potential reinfection of man. Persistence refers here to maximum survival time of final infective stage.

d. Life cycle involves two intermediate hosts. Latency is minimum time from excretion by man to potential reinfection of man. Persistence refers here to maximum survival time of final infective stage.

e. Multiplication takes place in intermediate snail host.

f. Fasciola, Gastrodiscoides, Heterophyes, and Metagonimus are also located in category V.

The subdivisions of the infections with latency (categories III-V) are also clear cut, with category III for the soil-transmitted worms, IV for the tapeworms that depend on access of cattle and pigs to human feces, and V for the trematodes and other worms requiring aquatic intermediate hosts. The subdivision of categories I and II is difficult and somewhat arbitrary, however, because the various concepts discussed above split the infections in these categories in different ways. For instance, if we divide categories I and II on the basis of median infective dose, stressing as we do so the grave limitations of the available data on infective dose, we arrive at the following approximate ranking (Table 14).

Increasing median infective dose:

<u>Enterobius</u>	
<u>Hymenolepis</u>	
<u>Entamoeba histolytica</u>	< 10 ² (Low)
<u>Giardia lamblia</u>	
<u>Balantidium coli</u>	
Enteric viruses	
<u>Shigella</u>	10 ⁴ (Medium)
<u>Salmonella typhi</u>	
Salmonellae	
<u>Yersinia</u>	> 10 ⁶ (High)
Enteropathogenic	
<u>Escherichia coli</u>	
<u>Vibrio cholerae</u>	

If, on the other hand, we list the infections according to their persistence outside their animal host, we arrive at approximately the following ranking (Table 14):

Increasing persistence:

<u>Enterobius</u>	
<u>Entamoeba histolytica</u>	
<u>Hymenolepis</u>	< 1 month (Low)
<u>Balantidium coli</u>	
<u>Vibrio cholerae</u>	
<u>Shigella</u>	
<u>Salmonella typhi</u>	< 6 months (Medium)
<u>Yersinia</u>	
<u>Giardia lamblia</u>	
Enteric viruses	< 1 year (High)
Salmonellae	
Enteropathogenic	
<u>Escherichia coli</u>	

Another important factor in predicting the impact of improved excreta disposal facilities may be whether or not there is a significant nonhuman reservoir of infection (Figure 2). Considering the category I and II infections, there are only two (the salmonellae and Balantidium coli) that have significant animal reservoirs.

A quite different approach to the division of categories I and II is to consider affluent communities in Europe (for instance) that enjoy high standards of sanitary facilities and hygiene, and examine which of the category I and II infections are commonly transmitted in these privileged communities. We might expect that infections that continue to be transmitted among people living in good housing with indoor plumbing and flush toilets will not be readily reduced by the introduction of limited sanitary improvements among poor people in the less developed countries. A division on this basis is approximately as follows:

		<u>Infective</u> <u>dose</u>	<u>Persistence</u>
Pathogens commonly transmitted within affluent communities in Europe	<u>Enteric viruses</u>	Low	High
	<u>Enterobius</u>	Low	Low
	<u>Giardia lamblia</u>	Low	Medium
	<u>Enteropathogenic</u> <u>Escherichia coli</u>	High	High
	<u>Salmonella</u>	High	High
	<u>Shigella sonnei</u> <u>Yersinia</u>	Medium High	Medium Medium
Pathogens rarely transmitted within affluent communities in Europe	<u>Balantidium coli</u>	Low	Low
	<u>Entamoeba histolytica</u>	Low	Low
	<u>Hymenolepis</u>	Low	Low
	<u>Salmonella typhi</u> <u>Shigella (other than</u> <u>sonnei)</u>	High Medium	Medium Medium
	<u>Vibrio cholerae</u>	High	Low

In some cases the reasons for this division are clear (for instance, the salmonellae continue to be transmitted from animals to man in affluent communities through contaminated foodstuffs), whereas in other cases (such as the continued success of Shigella sonnei in Europe) they are obscure.

Table 15 – Environmental Classification of Excreted Infections

<u>Category</u>	<u>Epidemiological feature</u>	<u>Infection</u>	<u>Dominant transmission focus</u>	<u>Major control measure</u>
I	Non-latent, low infective dose	Enterobiasis Enteroviral infections Hymenolepiasis Amoebiasis Giardiasis Balantidiasis	Personal Domestic	Domestic water supply Health education Improved housing Provision of toilets
II	Non-latent medium or high infective dose, moderately persistent and able to multiply	Typhoid Salmonellosis Shigellosis Cholera Path. <u>Escherichia coli</u> Yersiniosis <u>Campylobacter</u> infection	Personal Domestic Water Crop	Domestic water supply Health education Improved housing Provision of toilets Treatment prior to discharge or reuse
III	Latent and persistent with no intermediate host	Ascariasis Trichuriasis Hookworm	Yard Field Crop	Provision of toilets Treatment of excreta prior to land application
IV	Latent and persistent with cow or pig intermediate host	Taeniasis	Yard Field Fodder	Provision of toilets Treatment of excreta prior to land application Cooking, meat inspection
V	Latent and persistent with aquatic intermediate host (s)	Clonorchiasis Diphyllobothriasis Fascioliasis Fasciolopsiasis Gastrodiscoidiasis Heterophyiasis Metagonimiasis Paragonimiasis Schistosomiasis	Water	Provision of toilets Treatment of excreta prior to discharge Control of animal reservoirs Cooking
VI	Excreta-related insect vectors	Bancroftian filariasis (transmitted by <u>Culex pipiens</u>), and all the infections listed in I–V for which flies and cockroaches can be vectors	Various fecally contaminated sites in which insects breed	Identification and elimination of suitable breeding sites

Source: Feachem and others, Sanitation and Disease.

We believe that, for the time being, the most useful division of categories I and II is on the basis of infective dose, recognizing again that our knowledge of infective dose among malnourished peasant children in the tropics is nonexistent. Infective dose divides categories I and II in a way that makes sense theoretically and also corresponds to some degree with the likely impact of improved excreta disposal facilities.

Each category in Table 15 implies some minimum sanitary requirements for control of the diseases, and often ancillary inputs in addition to excreta disposal facilities if success is to be achieved.

The transmission characteristics of the first five categories are set out in Figure 3, which illustrates their typical survival, latency, and multiplication features. These in turn affect the "length" of transmission cycle involved. Length has implications beyond those of time, in that a long cycle is associated with opportunity to spread over a wider area and changes the pattern of risk. These issues are developed in the next chapter and represented in Figure 4, which also summarizes some of the conclusions we reach on the relative efficiency of sanitation improvements in controlling infections.

Category I. These are the infections that have a low infective dose ($< 10^2$) and are infective immediately on excretion. We argue that these infections may spread very easily from person to person whenever personal and domestic hygiene are not ideal (Figure 4). Therefore, it is likely that changes in excreta disposal technology will have little effect on the incidence of these infections if they are unaccompanied by sweeping changes in personal cleanliness that may well require major improvements in water supply and housing, as well as major efforts in health education. The important facet of excreta disposal is the provision of a hygienic toilet of any kind so that the people in a house have somewhere to deposit their excreta.

What subsequently happens to the excreta (i.e., how it is transported, treated, and reused) is of less importance because most transmission will occur in the home. Although transmission can and does occur by more complex routes, we argue that most transmission is directly person-to-person, and therefore the provision of hygienic toilets alone will have a negligible impact. Having said this, we must at once qualify this category, for categories I and II grade into each other and really form a continuum (see below). In particular, the parasitic protozoa have some features of each group. The extreme example of a category I parasite is the pinworm, Enterobius, whose sticky eggs are laid by emerging females on the anal skin so that transmission is by way of scratching fingers without depending much on eggs in the feces. At the other extreme, Giardia has been associated with well-documented waterborne diarrhea outbreaks, and therefore is presumably in part subject to control by excreta management.

Category II. The infections in this category are all bacterial. They have medium or high infective doses ($> 10^4$) and so are less likely than category I infections to be transmitted by direct person-to-person contact. They are persistent and can multiply, so that even the small

Figure 3. Survival Outside Host of Excreted Pathogens (categories I–V from table 15) Over Time

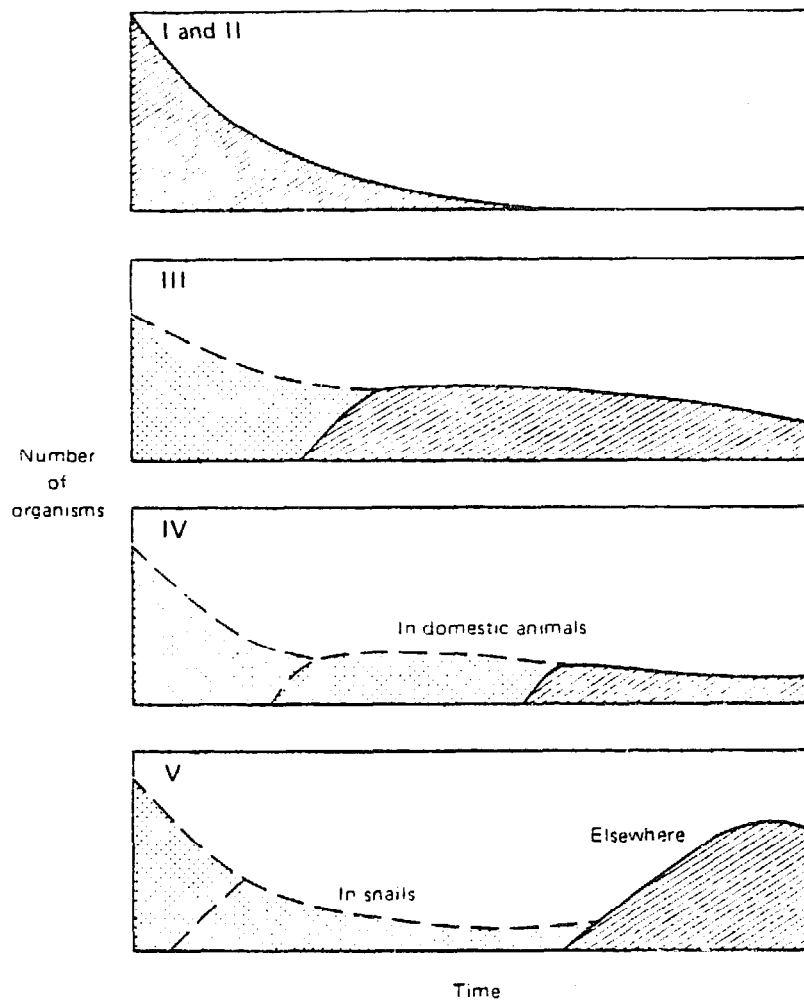

▨, Infective organisms; ▨, living but as yet uninformative stages (latency).

Note: The presence of both infective and latent stages indicates persistence.

Figure 4 — Length and Dispersion of Transmission Cycles of Excreted Infections (categories I—V from table 15)

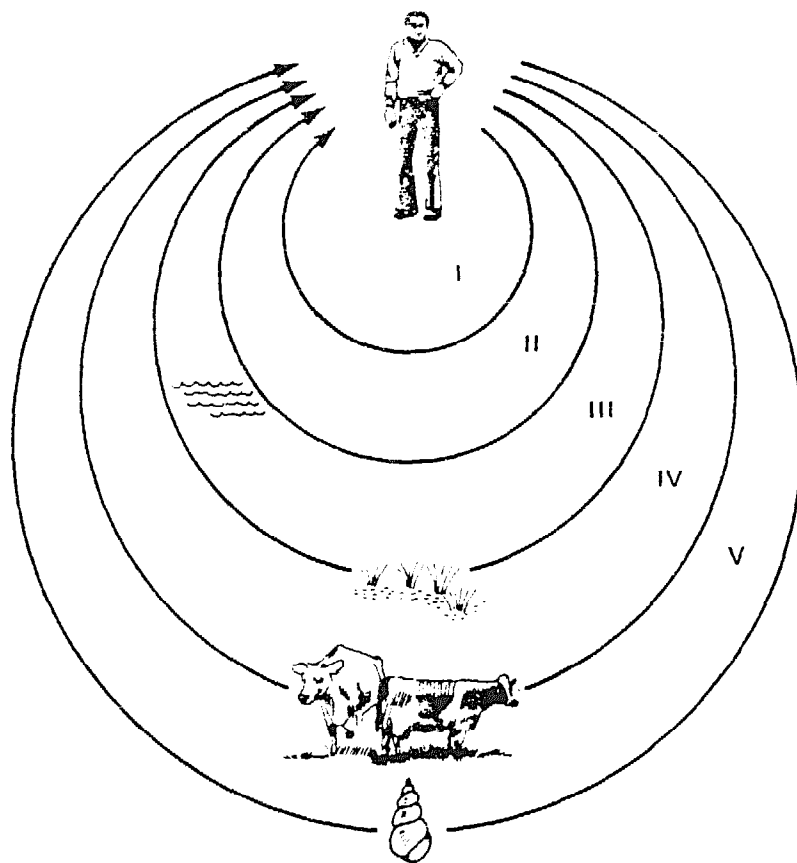

numbers remaining a few weeks after excretion can, if they find a suitable substrate (such as food), multiply to form an infective dose. Person-to-person routes are important but so too are other routes with longer environmental cycles, such as the contamination of water sources or crops with fecal material (Figure 4). The control measures listed under category I are important, namely water supply, housing, health education, and the provision of hygienic latrines, but so too are waste treatment and reuse practice. Changes in excreta disposal and treatment practices alone may have some small impact. This impact may be on those infections that, as we have noted above, are not normally transmitted among affluent groups in Europe or elsewhere. These are cholera, typhoid, and shigellosis, and any monitoring or evaluation program would do well to examine these, rather than infections with other salmonellae or pathogenic E. coli.

Characteristics of Categories I and II

The criteria used to separate these categories have been infective dose and "length" of the environmental cycle; our aim has been to predict efficacy of sanitation as a control measure. The reason they do not form tidy groups is the variable persistence of the pathogens involved. The extreme type I situation, with a low infective dose and environmentally fragile organism, will clearly tend to depend more on personal cleanliness and less on sanitation. (An extreme example, though not excreta-transmitted, is given by venereal diseases that do not survive in the environment and depend on intimate contact for their spread.) A low infective dose in an environmentally persistent organism, however, will lead to an infection very difficult to shift either by sanitation or by personal and domestic cleanliness. Many viruses fall into this category and pose major problems of control; induced immunity may be the best approach, as discussed above for poliomyelitis. In category II the role of sanitary improvements is to reduce the efficacy of the longer cycles and thus have greater overall benefit than for category I pathogens, in which these longer cycles are of little significance.

Category III. This category contains the soil-transmitted helminths. They are intent and persistent (Figure 3). Their transmission has little or nothing to do with personal cleanliness since the helminth eggs are not immediately infective to man. Domestic cleanliness is relevant only as it affects incoming infective stages by food preparation methods or the maintenance of latrines in a tolerable state so that eggs do not remain in the area for the days or weeks of their latent period. If ova are not deposited in soil or other suitable development sites, transmission will not occur. Therefore, any kind of latrine that contains or removes excreta and does not permit the contamination of the food, yard, or fields, will limit transmission. Because persistence is so long (see Table 14) it is not sufficient to stop fresh feces from reaching the yard or fields. Any fecal product that has not been adequately treated must not reach the soil. Therefore, in societies that reuse their excreta on the land, treatment is vital prior to application. As we discuss elsewhere (chapters 9 and 10), effective treatment for the removal of these ova requires waste stabilization ponds or thermophilic digestion, which through prolonged storage will remove many species.

Category IV. Category IV is for the beef and pork tapeworms. Any system that prevents untreated excreta being eaten by pigs and cattle will control the transmission of these infections (Figure 4). Cattle are likely to be infected in fields treated with sewage sludge or effluent. They may also eat feces deposited in the cowshed. Pigs are likely to become infected eating human feces deposited around the house or in the pigpen. Therefore, the provision of toilets of any kind to which pigs and cattle do not have access and the treatment of all wastes prior to land application are the necessary control methods. It is also necessary to prevent birds, especially gulls, from feeding on trickling filters and sludge drying beds and subsequently depositing tapeworm ova in their droppings on the pastures. Cooking of meat is the most important control measure in the absence of the measures described above. Personal and domestic cleanliness are irrelevant, except insofar as the use of toilets is concerned.

Category V. These are the water-based helminths that have an obligatory aquatic host or hosts to complete their life cycles. Control is achieved by preventing untreated night soil or sewage from reaching water in which the aquatic hosts live (Figure 4). Thus any land application system or any dry composting system will reduce transmission. There are two complications. First, in all cases except Schistosoma mansoni and S. haematobium, animals are an important reservoir of infection (see Tables 9 and 14). Therefore any measures restricted to human excreta can only have a partial effect. Second, in the case of S. haematobium it is the disposal of urine that is of importance and this is far more difficult to control than the disposal of feces. Because multiplication takes place in the intermediate hosts (except in the case of the fish tapeworm Diphyllobothrium), one egg can give rise to many infective larvae. A thousandfold multiplication is not uncommon. Therefore effective transmission may be maintained at low contamination levels and the requirements of adequate excreta disposal in terms of the percentage of all feces reaching the toilet may be demanding.

Category VI. The excreta-related insect vectors of disease comprise three main groups. Among the mosquitoes there is one cosmopolitan species, Culex pipiens, that preferentially breeds in highly contaminated water and is medically important as a vector of the worms that cause filariasis. The other two groups, flies and cockroaches, proliferate where feces are exposed. Both have been shown to carry numerous pathogenic organisms on their feet and in their intestinal tract, but their importance in actually spreading disease from person to person is controversial, though their nuisance value is great. Flies have also been implicated in the spread of eye infections and infected skin lesions.

The implied control measures are to prevent access of the insects to excreta. This may be achieved by many sanitary improvements of differing sophistication. In general, the simpler the facility the more care is needed to maintain it insect-free. Cockroaches, flies, and Culex mosquitoes often have breeding places in addition to those connected to excreta disposal and will in many cases not be controlled by excreta disposal improvements alone.

The way in which the categories correspond to the length of transmission routes is shown in Figure 4. The discussion has emphasized the importance of complementary inputs for control of most diseases. If excreta

disposal is improved in isolation, likely control of each category is as follows:

<u>Category</u>	<u>Control</u>
I	Negligible
II	Slight - moderate
III	Moderate - great
IV	Moderate - great
V	Moderate
VI	Slight - moderate

The outstanding difference is between categories I and II together, which depend so strongly on personal and domestic cleanliness, and the other categories, which do not. If one considers the changes necessary to control categories III and IV, they are relatively straightforward -- namely, the provision of toilets that people of all ages will use and keep clean and the treatment of fecal products prior to land application. The reason the literature on the impact of latrine programs often does not show a marked decrease in the incidence of category III and IV infections (see chapter 5 and appendix II) is because, although latrines were built, they were typically not kept clean, and they were not used by children or by adults when working in the fields.

CHAPTER 5

THE RISK OF EXCRETA TO THE PUBLIC HEALTH

5.1 INTRODUCTION

We have discussed at length the survival of pathogenic organisms in excreta, on which there is a good deal of data. In a precise sense this is the hazard from excreta that sanitary facilities seek to avoid. But the planner and economist will have a greater interest in epidemiological risk: if in a given situation specific changes in excreta disposal are provided, how much less disease will there be? This question can be rephrased in two ways, one of which can be answered readily and the other only with the greatest difficulty. The easier question is to ask what are the disease problems related to excreta and thus, by implication, related to inadequate excreta disposal facilities or to inadequate personal or domestic cleanliness. The difficult question is about the health benefits of improved sanitation: how much disease will go away if a given sanitary improvement is undertaken? Here we consider these questions in general terms.

5.2 ILLUSTRATIVE SKETCHES

A Southeast Asian Family

In high rainfall areas of Southeast Asia with a perennially hot climate and irrigated rice as the main cereal crop, the health hazards from excreta are diverse and may be illustrated by the following case history, a composite of several real sites and people. A family lives in a palm-roofed house of wood surrounded by rice fields and small irrigation channels, one of which, flowing near the house, acts as the domestic water supply. There are four children in the family: mother has had six babies but one died following a sudden attack of diarrhea at the age of fifteen months and a schoolchild died in the cholera epidemic that swept the area four years ago.

It is peculiarly difficult to control excreta in this damp environment; most feces are deposited not far from the house and the younger children urinate in the nearby canals. Some years ago a government campaign was mounted to provide pit latrines and one was dug near the family house. They used it for awhile, but in the monsoon season the pit flooded over and a large quantity of fecal material was spread around the house. It was around that time that the cholera epidemic occurred, and its sad consequences for the family together with the unpleasant mess discouraged them from using the pit latrine again. The next government recommendation was to build a concrete aquaprivy extending well above the ground to avoid the flood problem, but the family could not afford this and went back to defecating around the home during the day. Nocturnal excreta were collected in a bucket and deposited in a nearby fishpond.

How has this situation affected the family's health? All the children get diarrhea several times a year, and the parents do also from time to time. The worst occasion was when two girls, both under three years of age, got it at the same time and the younger one seemed to just shrivel up

overnight and she died the next day. This was due to rotavirus infection, but why it should more often be lethal in the tropics than in temperate countries is unclear. Maybe the poor sanitary facilities gave the child an overwhelming virus dose, or perhaps it was the malnutrition that is such a ubiquitous feature in the weaning period in communities such as this one. Most of the diarrheas are watery, sudden attacks, but last year Granny, who shares the house with them, was one of several people in the village who suffered an attack of a more painful diarrhea, with blood in the feces, from which she nearly died. Medicine from the dispensary four miles away seemed to help her turn the corner, but even so she remained ill for weeks. The attack was due to bacillary dysentery, though it would have been difficult to be sure it was not due to amoebiasis without a laboratory to check the diagnosis.

All these were dramatic illnesses, but the family had several more insidious health problems of which they are barely aware. The eldest son has not grown up properly; although he is twenty-three he looks as if he were in his early teens; his belly is always grossly swollen and the dispensary attendant can feel his hard liver and spleen under the tight skin. This is due to schistosomiasis spread from one person to another through a tiny snail living in the damp grass beside the canals as well as in the water itself. Several of the family are infected but only this boy has obvious disease.

With so much water around, fish is an acceptable and available food item, sometimes cooked but at others pickled in vinegar. A proportion of these fish are grown in ponds that are fertilized with human feces and this practice has caused some of the family to become infected by the helminth Clonorchis sinensis. Another helminth that the family has in large numbers is Fasciolopsis buski, acquired from eating uncooked aquatic vegetables. The results of neither of these parasites are catastrophic, but the diversion of food and other insidious effects make life less satisfactory than it otherwise would be. The family also suffers from many other intestinal worms that occur in even greater numbers and cause more illness. We shall discuss them in relation to another family below.

A nonintestinal infection is also associated with problems of excreta disposal. Within the pit latrines that have been flooded and abandoned, the fecal liquid is colonized by larvae of a mosquito known as Culex pipiens. When the adults of this mosquito bite the members of the household they are able to transmit the larvae of a parasitic worm that lives in the tissues under the skin of the legs and elsewhere. In particular, these worms inhabit the lymph nodes and block the flow of lymph. As a consequence the tissues become swollen from the accumulation of lymph and in some of the people a massive elephantiasis results; father is troubled by this in his right leg, which is so swollen that he cannot work in the fields as well as he could before.

A North African Village

We now visit an area quite different in general appearance, but behind this difference there are certain similarities in the disease problems. The village we are entering is a cluster of mud brick houses situated in the subtropics. In the winter it is quite cold, though the summer temperatures are at least as high as in the Asian village we have just visited. The

houses cluster together on a mound rising up from the irrigated areas around. This irrigation, however, is accomplished with water brought by great rivers from afar and is not due to heavy rainfall. The ground is baked hard where it has not recently been irrigated. Within the village the streets are narrow, they are not made up or paved, and large quantities of debris lie around.

The family we visit consists of parents with three children and some elderly relations. There is again the sad story of some children dying in childhood of diarrheal disease, and indeed it would be difficult to find a tropical area where this is not a problem. Only where very highly endemic malaria overshadows the picture and pushes the death rate even higher does diarrheal disease appear to recede into the background.

As in Asia we find problems of schistosomiasis and of elephantiasis. These are of a somewhat different type, it is true, but nevertheless they create disability in similar ways. In addition to the intestinal schistosomiasis, two of the younger children have a urinary variety and are passing blood in their urine every day. This looks dramatic but in fact the blood loss is not great. Nevertheless, they suffer pain and the inconvenience of having to get up to pass urine at night. Their uncle had to go to the hospital in the nearby big city only to be told that he had cancer of the bladder for which nothing could be done, and he died a very painful death. The surgeon said this was a late consequence of the same infection that was causing the blood in the urine of the children, though only a few unfortunate people suffered from it.

The helminths associated with fish and water plants that troubled the previous family are absent from this one, but when we look at their feces under the microscope we find the eggs of hookworm, roundworm, and whipworm in large numbers. The hookworm eggs are very numerous. Infection has been picked up by the family wandering about in bare feet on land that has been used for defecation and that has been kept moist enough by nearby drains and canals for the larval worms to develop in the soil. The hookworms are particularly numerous in the mother. They live in the small intestine and attach themselves to the villi (papillae on the inner surface) of the intestinal wall. They suck blood that is used for their growth and for production of their eggs, but they are very messy feeders and large amounts of blood pass straight through their body and are lost in the intestinal lumen. As a result the blood losses from this infection are heavy; indeed the mother's loss is twice as heavy as that from menstruation and, since her diet is not particularly rich in iron, she has become very anemic and is unable to work nearly as hard as a fit person. The same applies to one of the children of the family; his abdomen is swollen, he cannot run fast to keep up with the other children, and his condition gives considerable cause for anxiety. If he were to catch some other infection on top of the hookworm he might well lose his life.

All the family have roundworms. These are very large (over 100 millimeters in length) and every now and then one of the younger children passes one in the stool. This excites a little comment, but there is no obvious illness except for pain in the abdomen, and as always it is difficult

to ascribe this to a particular cause. What is certain is that the worms are absorbing a good deal of the nutrients intended for the children and there is also a risk that they will get stuck in the narrowest part of the intestine and block it, necessitating surgery. The family members are well aware of this problem and have visited the dispensary to get medicine on frequent occasions. Unfortunately, in the absence of better methods of depositing their excreta the infection comes back every few months. The adults seem to have become somewhat immune to it and the children carry the brunt of the infection.

What arrangements are made for excreta disposal here? A bore-hole latrine was made for each family to use but it filled up rather fast and was so unpleasant that none wanted to use it. In any case, it was in or near the house and the family spends much of the day down in the fields working hard on their rice and other crops. It would be a quite unreasonable waste of their time, or so they feel, to come all the way back to the home in order to defecate. It is also more convenient to do it in the field because their religion insists that they wash their anus after defecation and there is no water readily available for this purpose within the compound. Because of these varying sites for defecation, eggs of the roundworm Trichuris are spread rather widely throughout the environment. They are extremely resistant, even to the harsh climate of this part of the world, and find their way onto vegetables that are to be eaten raw. They also occur in the mud and sand of the compound where they are readily picked up by the babies.

Another intestinal worm of some importance is the beef tapeworm. This is acquired from the infected cow by eating undercooked beef, which readily occurs when meat is roasted on the outside of a large piece. The adult tapeworm grows up in the intestines of the family and it, too, competes for nutrients with the family. Its eggs, often in the swollen segments of the tapeworm, are shed in large numbers when a whole segment of tapeworm wriggles out of the anus. These tapeworm segments may be picked up by browsing cattle and undergo further development within the muscles of the cow. The family's religion prohibits the eating of pork, so they are spared from the tapeworm that has the added possible hazard of the larvae developing in human muscles.

All these helminth infections are long lasting and sap the strength, so that it is not easy to pin specific damage down to their action except in the case of hookworm. They are all infections that tend to be underrated because of their widespread nature and insidious, long drawn out course. By contrast, the family also suffers from several acute infections, not only diarrheas which have already been discussed, but also typhoid and hepatitis. The incidence of typhoid in the village is very high. This is for several reasons, not least of which are the defective excreta disposal arrangements. In addition, the presence of schistosomiasis in the inhabitants modifies typhoid and leads to a very long drawn out course of that disease, and up to one in every twenty-five people may become a typhoid carrier in some of these villages. This is over an order of magnitude higher than we see elsewhere. The upshot is that typhoid is extremely common, no less severe than elsewhere, and an appreciable cause of mortality. Hepatitis too occurs frequently. In the younger children it rarely gives rise to serious symptoms, but in adults the patient may have to take to his bed for weeks or months and sudden death is not unknown.

One feature that emerges with particular strength from this account of a family in North Africa is the extent to which it shares the fecal health problems of the family in East Asia. Indeed, unlike many other patterns of disease, there is a sameness that cannot be avoided. There are certainly infections that are peculiar to particular localities, but the pattern of diarrheal disease, enteric fever, numerous viral infections, and the intestinal worms is repeated throughout the world. Only cholera is of major importance and yet has a variable and patchy distribution.

5.3 CHILDREN

Many of the excreted infections that are the subject of this book have a very markedly nonuniform distribution of prevalence among different age groups. While all of them are found among people of all ages, many of them are concentrated in particular age groups. Table 16 notes the age group that is most afflicted by the main excreted infections in areas where these infections are endemic.

This table clearly shows that many of these infections are primarily infections of childhood, or that they afflict children as well as adults. This has the greatest relevance for disease control through excreta disposal improvements.

TABLE 16: The Age of Maximum Prevalence of Some Major Excreted Infections in Indigenous Populations of Endemic Areas

Category (Table 15)	Infection	Age Group in Which Highest Prevalence of Infection is Typically Found			
		Babies 0-2	Children 3-12	Teenagers 13-19	Adults 20+
I	Enteric viruses	*	*		
	Hepatitis A virus	*	*		
	Rotavirus	*			
	<u>Entamoeba histolytica</u>			*	*
	<u>Giardia lamblia</u>		*		
	<u>Balantidium coli</u>			*	*
	<u>Enterobius</u>	*	*		
<u>Hymenolepis</u>	*	*			
II	<u>Salmonella typhi</u>	*	*	*	*
	Other salmonellae	*	*		
	<u>Shigella</u>	*	*	*	*
	<u>Vibrio cholerae</u>		*		
	Path. E. coli	*			
<u>Yersinia</u>	*	*			
III	<u>Ascaris</u>		*	*	
	<u>Trichuris</u>		*	*	
	Hookworms		*	*	*
	<u>Strongyloides</u>		*	*	*
IV	<u>Taenia</u>			*	*
V	<u>Clonorchis</u>			*	*
	<u>Diphyllobothrium</u>			*	*
	<u>Fasciolopsis</u>		*	*	
	<u>Paragonimus</u>			*	*
	<u>Schistosoma spp.</u>		*	*	*

In all societies children below the age of about three will defecate whenever and wherever they feel the need. A proportion of these under-three-year-olds will be excreting substantial quantities of these pathogens. In some societies, the stools of these children are regarded as relatively inoffensive and they are allowed to defecate anywhere in or near the house. In this case it is highly likely that these stools will play a significant role in transmitting infection to other children and adults. This applies not only to those infections without a latency period but also to infections like Ascaris where the defecation habits of children will determine the degree of soil pollution in the yard and around the house and this, in turn, will largely determine the prevalence and intensity of ascariasis in the household.

In other societies, strenuous efforts are made to control and manage the stools of young children, either by making them wear diapers or by cleaning up their stools whenever they are observed. Either of these reactions should have an important controlling influence on the intrafamilial transmission of excreted helminths.

Between these two extremes there is a whole range of intermediate behavior patterns with regard to the reaction of adults to the stools of young children. In most poor communities, the picture is closer to the first example than to the second. The relevant response of government and other responsible agencies to this situation is health education of mothers to encourage a belief that stools of young children are dangerous and should be hygienically disposed of. The problem is primarily connected with attitudes and behavior. Nevertheless, the provision of some form of toilet for the disposal of the child's stool and, maybe more importantly, a convenient water supply will greatly assist child hygiene.

Children over three years are capable of using a toilet if one of suitable design is available. Children in the age range from three to twelve frequently do not use toilets even where they are available because:

- (a) they find it inconvenient and are not encouraged to by adults;
- (b) they are afraid of falling down the hole or of being attacked by the pigs that may live next to the latrine;
- (c) they cannot because the toilet is so designed that little people cannot use it; and
- (d) they are prevented from doing so by adults who do not want the children messing up their nice clean toilet.

As with the very young children, it is of vital importance that the stools of these children are hygienically disposed of because some of them will be rich in pathogens. The solution lies in a combination of the provision of a toilet that children are happy to use and health education for the mothers so that they compel their children to do so. Education for school children could also be effective here and it is vitally important that all schools have well-maintained latrines so that the children may learn from

positive experience. Indeed the whole subject of health education, so difficult to discuss incisively, is crucial to the health benefits of improved excreta disposal facilities (see chapter 13).

5.4 THE DISTRIBUTION OF SANITATION BENEFITS

We have compared and discussed the transmission cycles typically followed by categories I-V (Table 15 and Figure 4) and have indicated that categories I and II may follow "shorter" or "tighter" cycles than categories III-V. The implication is that the later categories are associated with a wider spread of the infections. This has importance in the selection of an excreta disposal technology and, in particular, in the willingness of an individual family to adopt an innovation. If a household head believes, or can be persuaded, that the adoption of a new technology will confer appreciable health benefits on his family, irrespective of what is taking place in the neighborhood, he will be more willing to innovate. If, on the other hand, it is clear that his action alone will have a negligible impact on his family's health, he is more likely to sit back and wait for clear evidence that a viable and effective program is being carried out throughout his neighborhood.

Where most transmission is intrafamilial, as in category I and to a lesser extent category II, it is to be anticipated that improvements in excreta disposal and cleanliness in an individual family may lead to health benefits for that family. As we have already argued, however, cleanliness is probably more important than excreta disposal facilities per se in the reduction of category I infections (and to a lesser extent category II) and therefore it is changes in hygienic behavior that may bring the greatest benefit to a single family in isolation from widespread changes in the community.

Turning to categories III-V, there is one infection that, although potentially having a long transmission cycle, is frequently transmitted within the family and is reducible by improvements in excreta disposal facilities without changes in personal cleanliness: ascariasis. Work in China and the U.S.A. in the 1920's showed that poor families who used their latrines and prevented their children from defecating in the yard had significantly lower intensities of Ascaris infection than their neighbors. In many situations one would anticipate that improvements in excreta disposal practice by a single family would lead to a demonstrable reduction in ascariasis within that family.

There are other specific circumstances in which a given infection may be readily reduced by the independent action of a single family. An example would be hookworm in rural India where, in many villages, much infection occurs when barefoot people visit the communal defecation grounds on the edge of the community. A family that installs a pit latrine and no longer visits the defecation ground may substantially reduce its exposure to hookworm infection.

When planning and implementing an excreta disposal program it may well be useful to identify an infection for which individual household action may be particularly effective. This infection might then be monitored and the results used as part of a propaganda exercise:

"The Sanchez family have adopted the new latrine and improved their domestic hygiene and now have less roundworms than their neighbors."

5.5 HEALTH BENEFITS OF SANITATION

We have outlined the major health problems associated with defective excreta disposal facilities. To relate the two causally, and in particular to say what the health benefits will be from a given proposed improvement of those facilities, is far more difficult. The difficulties and the studies attempting to overcome them are set out in this section. Critical comments must not obscure the fact that without improved excreta disposal the diseases discussed will not be overcome, but other complementary inputs, and in some cases major social, economic, and political changes, may be required for success to be achieved.

Methodological Issues

Studies of the health benefits of sanitation in the field have involved either comparing disease levels in communities with varying sanitary facilities or monitoring disease patterns before and after the improvement of sanitary facilities within a community. In both cases the difficulties in allocating benefits to the improved sanitation have arisen because other differences are often associated with the sanitation facilities. People who have better sanitation than their neighbors also often have higher incomes, better water supplies, and different habits of cleanliness. Similarly, if a single community is followed over time, the sanitary facilities are unlikely to be the only beneficial changes that befall the community. Therefore, to allocate all the benefits to improved sanitation would be unjustified.

Conversely, a study that demonstrates no health improvement on changing sanitary facilities cannot validly imply that they are useless. The facilities may have been left unused for lack of health education or may have been inappropriately sited, so that it will often be mistaken to generalize from a particular local result.

Ideally, the economist wishes to use health benefit data for deciding priorities in resource allocation. To do this, the total health benefits must be determined. Health as such, however, is not measurable (except possibly as growth of infants) and it is diseases that are studied. Sanitation affects a range of diseases, not all of which can be measured in a single study, so that usually a few indicator or index diseases are used to assess benefits. More often still, particular disease agents such as Shigella bacteria or worm eggs in the feces are assessed. The resulting measures or changes in infection rates with sanitation are several removes from health benefits and the intervening relationships are by no means linear. The relation between an infection and disease depends on many variables:

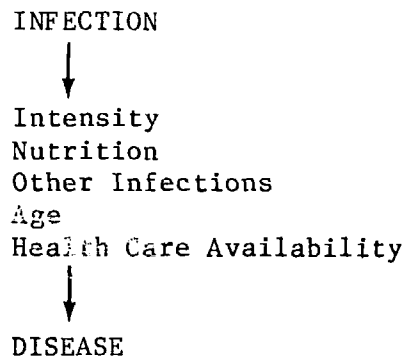

The Literature

We have compiled some of the relevant literature on impact assessment in appendix II. Almost none of the studies reported reaches the standards of epidemiological demonstration that would make the study conclusive, and therefore we have refrained from a melancholy criticism of each paper. Rather, the conclusions listed should be taken to indicate trends.

An important component of any evaluation, but one that is much neglected, is time. To attain comparability between an area that has received sanitary interventions and a comparable unsanitated area requires surveys done soon after installation of the sanitary facilities. Commonly the observations are made for up to a year and are begun months after construction. Such information has poor predictive value for the long term. If a special campaign has been mounted in relation to the new facilities, the results may be transiently impressive but fall off in the longer term. Conversely, the community may take some years to adjust to and utilize the innovations so that a short-term study fails to demonstrate the real benefits they bring. Where these problems are avoided, by the use of a very long-term study or by observing differences between communities with long-established differences in excreta disposal patterns, the difficulty of confounding variables arises: it is most unlikely that communities will stay comparable in all respects other than excreta disposal and its consequences over many years.

In the light of these issues, it is not surprising that studies of the benefits of excreta disposal as assessed by health changes in the field are almost all of an insufficient standard to be convincing. Very few indeed could be described as scientifically impeccable, producing results that inspire confidence. This discussion of methodology could perhaps be considered over precise and academic if most of the published studies gave concordant results, but this is far from the case and some studies are frankly contradictory.

A detailed critique of each study listed in appendix II is not given because the defects of sampling, comparability of samples, and confounded variables recur with such consistency, while use of facilities provided is scarcely ever assessed. Where recurrent treatment is used, studies are too short in duration to show the long-term outcomes and are usually also too brief to detect the large rise in noncompliance with therapy that tends to occur in time.

If we pool all these studies, it may not be unreasonable to hope for a halving of excreta-related diseases as a result of improved excreta disposal facilities together with reasonable supporting programs for maintenance and for health education. We already know that if these are combined with water supplies and appropriate behavior changes, the risk of many serious excreta-related diseases can become very small, and such conditions as typhoid and cholera cease to be endemic.

5.6 BENEFITS AND IMPACTS

Limitations

The planner seeks a clear, preferably monetary, statement of the health benefits of alternative sanitation improvements. The data are not adequate to provide one. It is quite feasible to list the present costs of treating sanitation-related diseases, but these are small relative to estimates of work and life that are lost due to their effects. These latter are subject to great uncertainty, and any figures put on them would be largely spurious.

Two examples may be given. Wagner and Lanoix (1969) attempted to estimate the costs of diarrheal disease and found that the largest component was due to premature death in children under the age of two years. There are several approaches to placing an economic value on deaths at this age, which give widely differing answers.

More recently, Latham et al. (1977) estimated the cost of Ascaris infection to Kenya. The largest single component is the estimated reduction in food absorption and utilization by those infected, given as \$4.4 million yearly, as compared with a total of \$0.7 million for all other costs, such as present treatment, health care, and transport to health care facilities. It is relatively easy to put forward reasons for changing the \$4.4 million by 50 percent or more in either direction.

On the other hand, it is possible to make informed assessments of the comparative benefits of different excreta disposal systems, and this we attempt below. No cost figures on different excreta disposal systems are given here. These may be found in the various other documents arising from the World Bank's investigations into appropriate sanitation technologies (for instance, Feachem, Mara, and Iwugo, 1978). It will be clear from our discussion of human behavior that the greatest determinants of the efficacy of alternative facilities are, first, whether they are used by everyone all the time and, second, how adequately they are maintained (see chapter 13). Use will be very dependent on the locality concerned; in urban situations, where alternative defecation sites are scarce, it will be easier to ensure widespread use of new facilities. There are both private and public aspects to maintenance of all but basic on-site systems, and the systems vary in their public maintenance needs. Some are more robust to public neglect than others.

Best Inferences with Optimal Behavioral Situation

To evaluate the health benefits of excreta disposal techniques, let us consider first a situation in which everyone uses the facilities all the time and the town council consists of paragons of municipal virtue so that

maintenance is exemplary! We are therefore comparing technologies rather than management systems.

The baseline situation will vary greatly in the absence of any sanitary provision. Where population densities are high, as in many parts of rural Asia and in all the world's major cities, the baseline level of disease due to excreted pathogens will be very high. On a crude ill-health scale we may consider this situation as 0. Under conditions of flush toilets, sewers, and an efficient treatment plant, the resulting health benefits are defined as 10, assuming that supplies of water are adequate for optimal use of the sanitary facilities.

Pit latrines would, from the viewpoint of health rather than convenience, approximate the same level, though not adapted to the water use levels needed for the personal cleanliness required to minimize the infections in categories I and II (Table 15). Given that a pit latrine has no effluent or product, however, it is in this regard safer than a sewerage system that produces large volumes of polluted effluent, which will in general not be made completely pathogen-free, even in the best treatment plant. A score of 9 is given to pit latrines. This conclusion does not apply where fecal material might soak through the latrine walls and ultimately mix with drinking water, nor where flooding or a high water table regularly recur.

Where composting double-vault latrines (score, 8) are used and digging out is more frequent, a residual hazard of long-lived helminth eggs persists and benefits are less. Reuse of the compost will spread the eggs in the community. The "multrum" type of composting latrine (score, 7) is again very safe if operated ideally, but in general risks will tend to be greater because the continuous process involves risks from organisms that have not been composted for long enough.

An aquaprivy with a long (> 1 month) retention time may produce an effluent with a low pathogen content. This requires regular topping up of the tank, but not at such a rate as to reduce seriously the retention time. Provided that an efficient sludge removal and treatment system is available, the resulting health benefits might approximate, say, 9 on the scale proposed above. A septic tank with a retention time of only one to three days produces an effluent rich in pathogens and therefore is associated with greater risk. A score of 8 is assigned.

With a bucket system, major reductions in diseases are unlikely, even in an ideal world, and a score of 5 is considered appropriate. A well-managed vacuum truck and vault system will be a great improvement, but some risk of spillage and contact with fresh feces still exists. A score of 8 is given.

The preceding sections have mainly concentrated on the on-site happenings. Where sewage is transported by cartage or water to a treatment plant, oxidation ponds for waterborne waste and batch thermophilic composting for solids and sludges will give a safe product. Alternative processes are inferior.

These results, summarized in Table 17, indicate that, when operated to high standards and fully used, there is little difference among health benefits of most processes. Only bucket latrines emerge as intrinsically and substantially inferior.

Best Inferences in the Real World

But of course in the real world things are not maintained impeccably, nor are facilities invariably used. In addition, some systems clearly require less effort to maintain and use than others. Cartage in some Japanese towns using vacuum trucks is fully comparable with waterborne sewerage. In another city known to the authors, 99 out of the 100 cartage trucks are reported to be out of operation. Health benefits are closely tied to operation and use and some societies are better than others at operating particular systems. When change is contemplated, much greater effort may need to be put into the operation and use, rather than just the installation, of the new facilities.

Operation and maintenance require both user effort and municipal endeavor and the necessary blend between these is different for different technologies. This can be illustrated by ranking the technologies as follows:

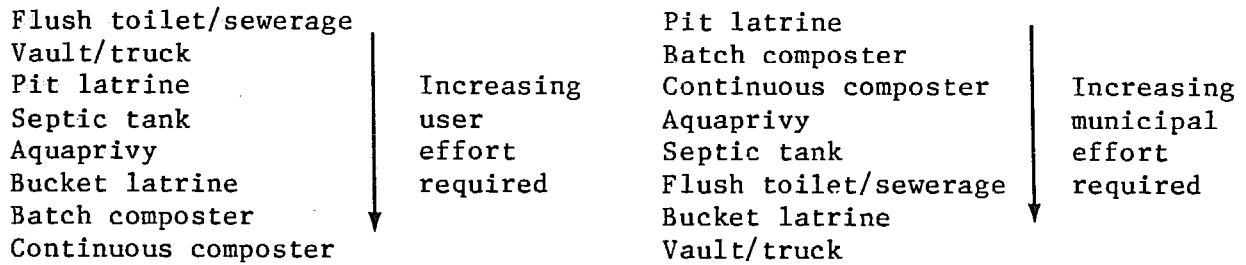

TABLE 17. A Speculative Ranking of Eight Excreta Disposal Technologies Based Upon Four Criteria

Criterion	Pit Latrine	Batch Composting (double vault)	Continuous Composting (Multrum)	Bucket Latrine	Vaults/ Vacuum Trucks	Aqua-privy	Septic Tank	Flush Toilet + Sewers + Ponds
Lack of need for user effort (0-10)	8	1	0	3	8	5	6	10
Lack of need for municipal effort (0-10)	10	10	10	1	0	5	5	4
Health benefits in real world (0-10)	6	5	3	1	6	6	7	9
Health benefits in ideal world (0-10)	9	8	7	5	8	9	8	10
Water needs	Low	Low	Low	Low	Low	Medium	High	High

Table 17 summarizes these speculations as well as putting a numerical value on the "real world" health benefits in the same way as was done above for the idealized conditions. This is a very provisional procedure and many other factors must be taken into account in selecting a technology for a given site. Nevertheless, Table 17 may stimulate thought about the health-related aspects of technology choice, and it serves to draw attention to the advantages of the pit latrine and the disadvantages of the bucket system.

CHAPTER 6

FECAL INDICATOR BACTERIA

6.1 INTRODUCTION

Fecal indicator bacteria are selected from among those commensal species that normally and exclusively live in the intestinal tract of man and other warm-blooded animals without causing disease. Because they are always and naturally present in feces and are excreted in large numbers (up to 10^9 or 10^{10} cells per gram of feces), their presence in water indicates beyond doubt that the water has been contaminated with fecal material and possibly with excreted pathogens. If a water is shown to contain fecal indicator bacteria, it is considered unsafe for human consumption. This is the rationale for the bacteriological testing of public water supplies that was developed in Europe and North America at the turn of the century, when the major concern of water supply engineers was to reduce the incidence of epidemics of strictly waterborne disease. It is still an epidemiologically valid testing technique for disinfected water supplies throughout the world, but it has certain limitations when applied indiscriminately in the examination of all wastes and wastewaters, particularly in hot climates. (These limitations are discussed in the section, "Relation of Fecal Indicator Bacteria to Excreted Pathogens," below.)

6.2 THE IDEAL FECAL INDICATOR BACTERIUM

The ideal fecal indicator bacterium should be:

- A normal member of the intestinal flora of healthy people;
- exclusively intestinal in habitat, and hence exclusively fecal in origin when found in the environment;
- absent from nonhuman animals (a requirement not met by any of the indicator bacteria currently used);
- present whenever fecal pathogens are present, and present only when fecal pathogens might reasonably be expected to be present;
- present in higher numbers than fecal pathogens;
- unable to grow outside the intestine, with a die-off rate slightly less than that of fecal pathogens;
- resistant to natural antagonistic factors and to water and waste treatment processes to a degree equal to or greater than fecal pathogens;
- easy to detect and count; and
- nonpathogenic.

No one bacterial species or group completely fulfills all these requirements, but a few come close to doing so and these are described below.

6.3 FECAL INDICATOR BACTERIA

In conventional water bacteriology there are three main groups of bacteria used as fecal indicators. These are: (i) the coliform bacteria; (ii) the fecal streptococci; and (iii) the anaerobe, Clostridium perfringens. Recently some members of the anaerobic intestinal flora, notably Bifidobacterium spp., have been proposed as additional indicator bacteria. Pseudomonas aeruginosa has also been proposed, but its status as an intestinal organism is in doubt.

Coliform Bacteria

There are two principal groups of coliform bacteria: the nonfecal coliforms and the fecal coliforms. The latter are exclusively fecal in origin, whereas the former, although commonly found in feces, also occur naturally in unpolluted soils and waters. Thus only the fecal coliforms are definite indicators of fecal pollution. In water bacteriology the nonfecal coliforms are regarded as "presumptive" indicators of pollution and should be absent from disinfected water supplies. In wastewater bacteriology, however, they are of considerably less importance, especially in hot climates where under suitable conditions they can multiply in the environment so that their presence or numbers are not necessarily related to either the occurrence of pollution or to its degree. Therefore, in general, and despite the one report from India to the contrary (Raghavachari and Iyer, 1939), only the fecal coliform bacteria should be used as indicators or "tracers" of fecal bacterial pathogens in wastes and wastewaters and in treatment and reuse processes in hot climates.

Under the microscope, fecal and nonfecal coliforms are indistinguishable; they are both Gram-negative rods, measuring some 2-5 micrometers x 0.4 micrometers. In practice they are differentiated by the ability of fecal coliforms, and the inability of nonfecal coliforms, to ferment lactose with the production of acid and gas within twenty-four to forty-eight hours at a temperature of 44°C. Additionally, the most common fecal coliform bacterium, Escherichia coli, can produce indole from tryptophan at this temperature. In hot climates, however, some nonfecal coliforms can grow at 44°C and some can also produce indole at this temperature, thus mimicking the fecal coliforms and E. coli in particular. There is no satisfactory routine methodology for detecting these organisms, and their occurrence has been the reason for the search in recent years for alternative, more satisfactory indicator organisms for use in hot climates.

Fecal Streptococci

The fecal streptococci (or Group D streptococci) are a group of bacteria that are morphologically similar (Gram-positive cocci, measuring approximately 1 micrometer in diameter and occurring in short chains of two or three cells) and that are mostly derived from the intestine of man and other warm-blooded animals. The group includes species unique to animals (Streptococcus bovis and S. equinus), other species with a wider distribution (for example, S. faecalis and S. faecium, which occur in man and other animals),

as well as two types (S. faecalis var. liquefaciens and an atypical S. faecalis that hydrolyzes starch) that appear to be ubiquitous organisms that occur in both polluted and unpolluted environments. These latter strains, essentially nonfecal streptococci, are not distinguishable from the truly fecal streptococci in routine detection or counting procedures. Since S. faecalis var. liquefaciens has been reported to be the predominant biotype present at low densities (below about 100 "fecal" streptococci per 100 milliliters), the usefulness of the fecal streptococci as an indicator group is open to question, especially in clean water bacteriology. Fecal streptococci may still have a place in wastewater bacteriology, however, except in considerations of the bacteriological quality of wastewater-irrigated crops on which the two nonfecal biotypes may be present as natural flora unrelated to the degree of fecal pollution. There is, however, no information on the distribution of these two biotypes in tropical environments.

Fecal Coliform to Fecal Streptococci Ratio

It has been found in the U.S.A. that human feces contain at least four times as many fecal coliforms (FC) as fecal streptococci (FS), but that animal feces contain at least 1.4 times as many fecal streptococci as fecal coliforms. Thus it was suggested that American surface waters that have FC/FS ratios of > 4 are likely to be receiving predominantly human pollution, while those with ratios of < 0.7 may be mainly contaminated by the feces of wild and domestic animals (Geldreich, 1966).

This method, however, is of little value in practice. The FC/FS ratios in fresh feces may vary widely among different species and in different geographical locations. There is no reason to believe that humans the world over excrete a ratio of > 4 , while animals excrete < 0.7 . Once the feces have been excreted, the ratios will change because of the differential death rates of the various bacteria. Typically, the enterococci (S. faecalis, S. faecium, and S. durans) survive for longer than fecal coliforms, which survive for longer than S. bovis and S. equinus (McFeters et al., 1974). Therefore, it has been suggested that in humans, where enterococci are the dominant FS species, FC/FS ratios of samples returned to the laboratory will fall, whereas in animals, where S. bovis or S. equinus may be more numerous, the ratios in stored samples may rise (Feachem, 1975). It now appears, however, that while enterococci are the dominant FS species in humans in developed countries, and therefore human pollution is associated with falling ratios, they can also be the dominant FS species in domestic animals in Scotland (Oragui, 1978).

Further, S. equinus and S. bovis are common in the feces of people in India and Uganda. Therefore we conclude that neither the ratio at the time of sampling nor the change in ratio in a stored sample conveys much useful information about the origins of fecal pollution.

Clostridium perfringens

Clostridium perfringens (formerly C. welchii) is an anaerobic spore-forming bacterium; it is Gram-positive and measures approximately 4-6 micrometers in length by 1-2 micrometers in width. It is exclusively fecal in origin and it is also pathogenic, causing gas gangrene and food poisoning. Since it is a spore-forming organism it can persist for long periods outside the intestine

and can therefore be used as an indicator of occasional or intermittent pollution or of previous pollution of waters in which the presence of neither fecal coliforms nor fecal streptococci can be demonstrated. It is also more resistant than both fecal coliforms or fecal streptococci to antagonistic substances such as chlorine. In wastewater bacteriology, however, the long persistence of C. perfringens is a disadvantage because it can give rise to residual dormant populations that may not reflect the degree of pathogenic contamination remaining. Type-A C. perfringens from human feces may grow in the soil; this is in contrast to other types of C. perfringens of animal origin, which seem to die out in the soil.

Pseudomonas aeruginosa

This organism is a pathogen of man causing wound infection, especially of burns, and occasionally otitis media and infections of the urinary tract. It is a Gram-negative rod, measuring approximately 0.5 micrometers by 2 micrometers. It occurs in the feces of a relatively low proportion (about 3-15 percent) of healthy people but is said to be extremely rare in animals. Its occurrence in waters has been said to be associated with fecal pollution; counts >1,000 fecal coliforms per 100 milliliters and <1 P. aeruginosa per 100 milliliters in the same water being associated with animal, rather than human, pollution (Green et al., 1975) has shown that the soil can act as a reservoir for P. aeruginosa.

P. aeruginosa probably does not grow in the intestine of healthy people. Those organisms isolated from feces probably represent the survivors of ingested organisms. Studies in which these organisms were fed to volunteers demonstrated that large numbers must be ingested to maintain fecal carriage. P. aeruginosa is common in sink traps and flower water and is probably common in all static waters.

Bifidobacteria

Bifidobacteria are nonsporulating anaerobic organisms that occur in the intestine of man and warm-blooded animals. They are Gram-positive V- or Y-shaped cells with each branch measuring about 0.8 micrometers by 3-4 micrometers. The most common species in man are Bifidobacterium adolescentis and B. longum. Bifidobacteria have been recently proposed as indicator organisms for use in tropical waters because they are exclusively fecal in origin and do not grow outside the intestine. They thus overcome the principal disadvantage of fecal coliform counts on tropical samples, which may contain a significant proportion of strains that can ferment lactose and produce indole at 44°C but are not derived from feces. Work on bifidobacteria has only recently commenced, and there is little information on their survival in the natural extra-intestinal environment other than in river waters (Evison and Morgan, 1978).

Other Anaerobic Bacteria

The bacterial flora of feces is predominantly composed of anaerobic bacteria. Bifidobacteria have been described in the previous section but feces contain large numbers of other nonsporulating anaerobes, such as Bacteroides spp. (commonly B. fragilis), the anaerobic Gram-positive cocci (Peptococcus spp. and Peptostreptococcus spp.), and Eubacterium spp. Current research work is investigating the usefulness of these organisms (especially

Bacteroides fragilis) as fecal indicators, but at present there is insufficient data on their extra-intestinal ecology to know whether or not they, or some of them, are likely to be useful indicator organisms in practice. Moreover, current techniques for their detection and enumeration are rather too complex for routine use.

Concentrations of Indicator Bacteria in Feces

Approximate numbers of indicator bacteria commonly found in human feces are given below in cells per gram (wet weight) of feces.

<u>Indicator bacteria</u>	<u>Numbers</u>
Fecal coliforms	$10^6 - 10^9$
Nonfecal coliforms	$10^7 - 10^9$
Fecal streptococci	$10^5 - 10^8$
<u>Clostridium perfringens</u>	$10^1 - 10^7$
<u>Pseudomonas aeruginosa</u> /1	$10^3 - 10^5$
<u>Bifidobacterium</u> spp.	$10^8 - 10^{11}$
<u>Bacteroides</u> spp.	$10^8 - 10^{11}$

These figures are average figures only and mainly derived from American literature. Some communities, because of dietary differences, may display considerably different numbers for one or more of the above indicator groups; for example, feces from Indians often have much lower fecal coliform densities, sometimes as low as $10^2 - 10^4$ cells per gram.

Detection and Enumeration of Indicator Bacteria

Methods suitable for the detection and enumeration of coliform bacteria, fecal streptococci, and Clostridium perfringens are described in the 14th edition of Standard Methods for the Examination of Waters and Wastewaters (American Public Health Association, 1975) and in the 4th edition of The Bacteriological Examination of Water Supplies (Department of Health and Social Security, 1969). Pseudomonas aeruginosa populations can be counted by membrane

1. P. aeruginosa has been reported to occur in large numbers ($10^3 - 10^5$ per gram) in feces; there is some doubt, however, as to the meaning of these results. P. aeruginosa may be regarded as an environmental organism occasionally found in feces. A count of 50 (or less) per gram of feces would be regarded as normal.

Filtration using the medium of Levin and Cabelli (described in Standard Methods) supplemented with 0.1 percent cetrimide. The membrane filtration method and medium for Bifidobacterium spp. are described by Evison and Morgan (1978). Reference may also be made to Mara (1974).

1.4 RELATIONSHIP OF FECAL INDICATOR BACTERIA TO EXCRETED PATHOGENS

Fecal indicator bacteria were originally developed to assess the bacteriological quality of potable waters at a time when the transmission of bacterial enteropathogens (such as salmonellae, shigellae, and cholera vibrios) was considered to be the major risk to public health associated with drinking water supplies. Therefore, historically (and indeed, to some extent, even now), the major emphasis has been on the relationship between the fecal indicators and bacterial pathogens. Even the recent literature contains many reports on the persistence of, for example, fecal coliforms and salmonellae in the extra-intestinal environment, but only a very few reports on the comparative survival of the fecal indicators and nonbacterial fecal pathogens such as viruses, protozoa, and helminths. This has been partly due to the difficulty of routinely analyzing samples for these other pathogens (especially the viruses), but it has also probably been due to an uncritical carry-over of the historical approach outlined above. Thus, for example, there has been no report on the relationship between the indicator bacterium lostridium perfringens and the ova of the fecal helminth Ascaris lumbricoides, which persists for longer periods in the extra-intestinal environment than the indicator bacteria and excreted helminths, respectively. Such a relationship would be of little value in assessing the safety of urban water supplies (for which Ascaris ova are not organisms of public health significance), but it might be of value in assessing the quality of, for example, sewage sludges, composted feces, and some wastewater effluents.

This example emphasizes the historical but persistent preoccupation of sanitary bacteriologists with urban water supplies to the near exclusion of appropriate consideration for wastes and wastewaters and the comparative removal and persistence of fecal pathogens (of whatever type) and indicator bacteria in treatment processes and reuse products. We cannot, for example, even predict with confidence the likely density of salmonellae in a tropical sewage effluent, even though we know the number of fecal coliforms present; in contrast we can make a reasonable estimate if we are dealing with a temperate climate effluent. This situation results because there is much data (mainly from North America), admittedly of variable quality, on the relationship between the survival of bacterial pathogens and indicators in sewage treatment processes in temperate climates, but very little data from tropical countries. This makes the establishment of a fecal coliform standard for most tropical sewage effluents a highly unscientific process. Since engineers design, for example, maturation pond systems on the basis of fecal coliform removal to achieve the desired standard, this state of scientific uncertainty can lead to either over-design (with a consequently unnecessary increase in cost) or to under-design (with a consequently increased risk and perhaps actual damage to public health).

When we consider the hazards from nonbacterial excreted pathogens, the bacterial fecal indicator organisms are of limited usefulness. They are of some use in assessing the quality of irrigation waters and resulting risks

to health, but even here the gaps in our knowledge are considerable. Much of the information we have comes from relatively sophisticated communities (e.g., North America, South Africa, Israel), and we cannot apply this data with much confidence to other communities where climate, diet, disease patterns, agricultural practice, and cultural attitudes toward excreta reuse products are all different. This does not mean that we cannot use information on, say, fecal coliform survival in Israel to predict fecal coliform survival in, for example, rural India. It does mean that the information may not be all that relevant to conditions in rural India where the ability to make statements about fecal coliform survival may not be very helpful in assessing the degree of fecal pathogen contamination of crops irrigated with sewage effluent or fertilized with treated excreta. Thus some caution is to be exercised in assessing the significance of data on fecal indicator survival environments considering the area from which the information was obtained.

In summary, therefore, we have very little knowledge on the relative concentrations of indicator bacteria and bacterial pathogens in effluents and fecal products in warm climates, and we have practically no information about the relative concentrations of indicator bacteria and nonbacterial pathogens. In addition, we must note that the stability of the ratio between the concentration of an indicator bacteria and the concentration of a particular pathogen decreases as the size of the contributing population decreases. Thus, for systems serving small communities or for individual systems such as aquaprivies or composting toilets, the ratios will vary enormously from place to place and through time, and no organism will act as a good indicator of another organism.

6.5 PATHOGEN INDICATOR ORGANISMS

Fecal indicator bacteria are indicative only of fecal contamination. This is useful in assessing the safety of drinking water supplies, but when we are considering the health aspects of sanitation systems and excreta and sewage treatment and reuse processes, what we need is not a fecal indicator organism (for we already know that we are dealing with feces), but rather a pathogen indicator organism. We need to have a reliable measure of the pathogen content of the end-product of a treatment process so that we can assess as accurately as possible the health risks associated with any reuse of the end product or with its discharge into the environment. If we can assess these risks meaningfully, then we can decide in a responsible and informed way whether the benefits resulting from end-product reuse outweigh the possible costs to health of those involved (either as producers or consumers) in the reuse process or, in the case of discharge of the end-product into the environment, of the users of the environment.

It would be unrealistic to expect the same pathogen indicator organism to be useful in assessing the pathogen content of different types of fecal products, for example, waste stabilization pond effluent and composted feces. In the latter case we are primarily concerned with the viability of the persistent helminths, notably Ascaris lumbricoides, whereas with ponds we know that, if the total retention time is more than twenty days, the pond effluent will be free of both helminth ova and larvae but may contain excreted viruses and bacteria.

It is convenient to divide fecal products into two groups, effluents and noneffluents, and to examine which organisms are suitable pathogen indicators for each.

Pathogen Indicators for Effluents

It is convenient to consider the effluents from waste stabilization ponds and other sewage treatment processes separately because the vastly different retention times (weeks in ponds, hours or days in other processes) produce effluents of markedly different pathogen content.

Pond Effluents. It is known that if a pond effluent has a retention time of more than twenty days, its effluent will be free from both pathogenic protozoa and helminth ova and larvae, but it may well contain viral and bacterial pathogens. Since the routine analysis of pond effluents for viruses and bacterial pathogens is not yet feasible (nor likely to become so in the immediate future), the choice of a suitable pathogen indicator is exceedingly difficult. Bacteriophages and, more specifically, coliphages may provide a solution in the future, but the laboratory techniques are not yet widely known. Fecal coliforms or fecal streptococci present themselves as the obvious choice, but there is little data on their usefulness as viral indicators and the literature on their comparative survival with bacterial pathogens is only fractionally less scant, especially for tropical pond effluents. There is no information available on the usefulness of bifidobacteria and the other nonsporulating anaerobes. Probably the best that we can currently do is to recommend the use of fecal coliforms and fecal streptococci, even though they are less than ideal for the purpose--especially as regards virological quality. What is even less certain is what densities of fecal coliform or fecal streptococci should be permissible. The rather unhelpful answer is that they should be as low as possible, which in practice means at least below 1,000 per 100 milliliters of effluent and preferably below 100 per 100 milliliters. Effluents that are reused for the irrigation of crops consumed raw must have fecal coliform and fecal streptococci counts that are both below 100 per 100 milliliters. We cannot say with certainty that viral 1/ and bacterial pathogens will be absent at these indicator organism densities, but we can be confident that the health risks will be minimal and that further treatment will not normally be economic.

Effluents from Other Sewage Treatment Processes. The effluent produced by sewage treatment processes other than waste stabilization ponds are likely to contain the full range of fecal pathogens--viruses, bacteria, protozoa, and helminths. There is no suitable fecal indicator organism in these circumstances; it is just not possible to have a single organism indicative of the presence of so diverse a group of pathogens. Fecal coliforms have been used, but only for historical reasons; they are totally inappropriate indicators for the helminths, at least. We can only conclude this subsection by

-
1. It may be noted that a meeting of experts in Mexico in 1974 recommended a very stringent virological standard for recreational water of < 1 per 40 liters of water (Melnick, Gerba, and Wallis, 1978).

saying that if a sound economic argument can be put forward for the use of treatment processes other than ponds, then the effluent should undergo tertiary treatment or be heavily disinfected or discharged well out to sea since, in the tropics, the health risks associated with the effluent may be similar to those associated with raw sewage. It should be noted that even heavy disinfection will not kill all viruses and will be completely ineffective against some helminth ova.

Pathogen Indicators for Noneffluents

Noneffluents are taken here to include night soil, the contents of pit latrines and composting toilets and the sludges from aquaprivies, septic tanks, and conventional sewage treatment works. It is reasonable to assume that where ascariasis is endemic, if there are no viable Ascaris ova present in these wastes, then other pathogens are absent as well, since Ascaris eggs are so resistant. Thus (and in the current absence of any data on the comparative survival of Clostridium perfringens) the viable ova of Ascaris lumbricoides would appear to be the best pathogen indicator currently available for non-effluents. This has been accepted in China where standards of > 95 percent Ascaris ova mortality have been adopted for agricultural reuse of excreta (McGarry and Stainforth, 1978).

CHAPTER 7

SURVIVAL OF INDICATORS AND PATHOGENS

7.1 INTRODUCTION

From the time of excretion, the concentration of all pathogens will usually decline due to the death or loss of infectivity of a proportion of the organisms. Viruses and protozoa will always decrease in numbers following excretion. Bacteria may, if they find themselves in a suitably nutrient-rich environment with a minimum of competition from other microorganisms, multiply. This sometimes occurs when salmonellae, for instance, contaminate certain foods, or when E. coli multiplies in a chlorinated sewage effluent from which many other bacteria have been eliminated. Multiplication of pathogens is very uncommon, however, and is unlikely to continue for very long. Intestinal helminths will decrease in numbers following excretion, except for the trematodes, which have a multiplication phase in their molluscan intermediate hosts. The possibility of multiplication for the excreted pathogens is summarized in Table 14.

We define the ability of an excreted organism to survive as its "persistence," and this concept is discussed in chapter 4. The natural death of organisms when exposed to a hostile environment is of the utmost importance because it causes the infectivity of excreta to decrease, irrespective of any treatment process. Some treatment processes have little effect on excreted pathogens; they simply allow the necessary time to elapse for natural die-off to occur. The effect of conventional sewage treatment on protozoan cysts is of this kind. Certain treatment processes, however, create conditions that are particularly hostile to excreted pathogens and promote their rapid death. The effects to activated sludge on fecal bacteria or of thermophilic digestion on all organisms are of this kind.

The success of a given treatment process in reducing the pathogenicity of an effluent or sludge thus depends upon its retention time and also on whether it creates an environment that is especially hostile to particular organisms. The only condition, likely to be found in a night-soil or sewage treatment system, that is highly fatal to all pathogens in a reasonably short time (a few hours) is raised temperatures (in the range 55-65°C). The only other low-cost process that causes 100 percent removal or destruction of most pathogens is the waste stabilization pond system because of its long retention times, exposure to sunlight, and good sedimentation properties.

The element of time is a feature common to all treatment, disposal, and other reuse technologies and, in many cases, it is the feature that most determines the pathogen removal achieved. The rate of loss of infectivity of an organism depends very much on temperature, and most organisms survive well at low temperatures (< 5°C) and rapidly die at high temperatures (>40°C). Except in sludge or night-soil digestion processes, however, temperatures approximate ambient temperatures, which means in most developing countries that they are generally in the range 15-35°C, and commonly 20-30°C. It is thus very useful to know the persistence of pathogens at ambient temperatures in different environments in order to predict the likely pathogen content of

various fecal products. In this section we review the literature on pathogen survival at ambient temperatures, considering in turn survival in feces, night soil, and sludge; survival in water and sewage; survival on soil; and survival on crops. Under each heading we have tried to summarize the available knowledge as succinctly as possible. We have prepared appendices that list the individual studies and summarize the individual findings.

The shape of the curve that describes pathogen survival with time should determine the way in which survival is reported. Many bacterial populations decay exponentially so that 90 percent or 99 percent will be lost relatively quickly but a few organisms will persist for long periods. Such a situation is best described by the probability of survival for a given time or by the "half-life," the time that elapses before half the population is dead. For instance, 50 percent of fecal coliforms may die in twenty hours in water, while a few may persist for up to fifty days; the results obtained will depend heavily on sampling procedures. Most of the literature gives data on the persistence of small proportion of long-term survivors, while only a few authors have reported the shape of the death curve or given the 50 percent or 90 percent destruction times. Therefore the discussion here will be mainly in terms of overall persistence of a few organisms. This is an epidemiologically appropriate approach where the organisms can subsequently regrow if they find themselves on food or other suitable substrate (e.g., the shigellae, salmonellae, and pathogenic *E. coli*) or if the infective dose is believed to be low (as with the viruses). It is less appropriate in cases where regrowth is unlikely and where infective doses may be high, as for example with *Vibrio cholerae*. In these cases, it is the rapid death of the bacteria to a level at which they no longer represent a major public health hazard that is important. Where there are several developmental stages outside the human host, as with hookworms and schistosomes, each stage will have its own separate survival pattern. Where the parasitic stage is actively moving but depends on an unreplenished energy source, as with a schistosome miracidium seeking its snail host, its length of life may be precisely defined.

7.2 SURVIVAL IN FECES, NIGHT SOIL, AND SLUDGE

There is less literature on the survival of pathogens in these media than in the aqueous environments discussed in the following section. Some of it refers to survival of pathogens in sewage work sludges, but it may be anticipated that survival in feces and night soil is broadly similar. The position may be summarized as follows:

<u>Pathogen</u>	<u>Survival Time</u>
Enteric viruses	Up to five months, but usually less than three months
Indicator bacteria	Up to five months, but usually less than four months
Salmonellae and shigellae	Up to five months, but usually less than one month
Vibrios	Usually less than five days
Tubercle bacilli	Up to two years, but usually less than five months
Protozoan cysts	Up to one month, but usually less than ten days
Helminth ova	Very variable depending on species, but <i>Ascaris</i> ova may survive for many months.

A compilation of original sources and findings on survival in feces, night soil, and sludge will be found in appendix III.

7.3 SURVIVAL IN WATER AND SEWAGE

Many studies on the survival of excreted organisms in water and sewage have been conducted. For all organisms, survival is highly dependent on temperature, with greatly increased persistence at lower temperatures. Survival of bacteria is also very dependent upon the presence of other microorganisms in the water that might provide competition or predation. Bacterial survivals are often very much longer in clean water than in dirty water, and the longest survivals are obtained by inoculating a single species of bacteria into sterilized water. There is some evidence that the opposite may be true for viruses, presumably due to some protective effect that the viruses may receive when they are absorbed onto solid particles in dirty water. Coliforms, in particular E. coli, have attracted most interest; regrowth is possible in organically polluted waters but this growth phase will give way to a progressive die-off. Survival in excess of fifty days is most unlikely and, at 20-30°C, twenty days is a more likely maximum survival time. Mixed fecal streptococci have a similar (perhaps a little longer) survival, but if the streptococci are predominantly S. bovis or S. equinus, the survival times are substantially shorter.

Salmonella survival has also been widely reported. Survival up to three months has been recorded, but one month is a more common upper limit. Shigella and Vibrio cholerae are less persistent, and survival for more than twenty days is seldom reported.

The development of viral detection techniques in the 1950's led to the demonstration of enteric viruses in sewage. The presence of polioviruses, coxsackieviruses, echoviruses, reoviruses, and hepatitis A virus has been reported by several researchers and the literature on this subject is blossoming at the present time. Viral survival may be longer than bacterial survival and is greatly increased at lower temperatures. In the 20-30°C range, two months seems a likely maximum survival time, whereas at around 10°C, nine months is a more realistic figure.

Protozoan cysts are poor survivors in any environment. A likely maximum for Entamoeba histolytica in sewage or polluted water is about twenty days. Helminth ova vary from the very fragile to the very persistent. The most persistent of all are Ascaris ova, which may survive for a year or more.

A compilation of original sources and findings on survival of pathogens in water and sewage will be found in appendix IV.

7.4 SURVIVAL ON SOIL

Survival times on soil are relevant in all situations where effluent, sludge, compost, or other fecal products are being applied to the land as fertilizers or soil conditioners. Gerba, Wallis, and Melnick (1975) consider that the following factors affect the survival time of enteric bacteria in soil:

- Moisture content: greater survival time in moist soils and during times of high rainfall;
- moisture-holding capacity: survival time is less in sandy soils than in soils with greater water-holding capacity;
- temperature: longer survival at low temperature; longer survival in winter than in summer;
- pH: shorter survival time in acid soils (pH 3-5) than in alkaline soils;
- sunlight: shorter survival time at soil surface;
- organic matter: increased survival and possible regrowth when sufficient amounts of organic matter are present; and
- antagonism from soil microflora: increased survival time in sterile soil.

Fecal coliforms can survive for several years under optimal conditions. Nevertheless, 99 percent reduction is likely in not more than twenty-five days in warm climates. Fecal streptococci is likely to last longer if human enterococcal species are dominant. Survival of Salmonella may be up to one year if the soil is moist and rich in organics (e.g., if it is fertilized), but strain variation is considerable and fifty days would be a more typical maximum. Data on Shigella or Vibrio cholerae survival in soil are not available.

The information that is available on viruses suggests that virus particles adsorb to soil particles and become protected from the environment. Virus survival is greater at low temperatures. Survivals up to around three months have been reported in warm weather, as compared with up to six months under European winter conditions.

Protozoan cysts in soil are most unlikely to survive for more than ten days. Helminth survival varies enormously, but Ascaris ova can survive for several years. A compilation of original sources and findings on survival in soil will be found in appendix V.

7.5 SURVIVAL ON CROPS

Studies have shown that bacteria and viruses cannot penetrate undamaged vegetable skins. There are, however, many reports in the literature on the isolation of all kinds of pathogens from the surface of vegetables that have been irrigated or fertilized with fecal products. Weather conditions have an important influence on the survival of pathogens on plants. Many hours of sunshine will promote death, as will low air humidity. Root vegetables are more prone to contamination than others.

The survival characteristics of various excreted organisms may be summarized as follows:

<u>Pathogen</u>	<u>Survival Time</u>
Enteric viruses	Up to two months, but usually less than one month
Indicator bacteria	Up to several months, but usually less than one month
Salmonellae	Up to six months, but usually less than one month
Vibrios	Usually less than seven days
Protozoan cysts	Usually less than two days
Helminth ova	Usually less than one month.

In summary, survival times on vegetables are short compared to survival in other environments. Cysts are very rapidly killed. Surprisingly, bacteria and viruses survive better than Ascaris ova but very little survival of any species is to be expected after two months.

A compilation of original sources and findings on survival on crops will be found in appendix VI.

CHAPTER 8

APPROPRIATE PHILOSOPHIES REGARDING PATHOGEN SURVIVAL AND WASTE TREATMENT

8.1 APPROPRIATE PHILOSOPHIES FOR THE CONSIDERATION OF PATHOGEN SURVIVAL

In this report we consciously refer to pathogen survival rather than pathogen removal. Figures like 99 percent removal appear highly impressive, but they represent 1 percent or 0.1 percent survival, respectively, and this level of survival may be highly significant where incoming concentrations are great. If an influent sewage to a treatment works contains, say, 10^3 pathogenic bacteria per liter, then 99 percent removal will produce an effluent with 10^3 pathogenic bacteria per liter. In areas where the effluent is to be reused, or where it is to be discharged to a stream that downstream populations use a source of drinking water, this effluent quality may not be adequate.

We believe that the emphasis in the literature on the exact proportions of pathogens removed by various treatment processes is misleading. For instance, as we discuss in section 10.3, most conventional treatment plants remove between 90 percent and 99 percent of enteric bacteria. This is a very poor removal rate, and it matters not whether trickling filters may remove a little less (say, 95 percent) than activated sludge plants (say, 99 percent); they are both technologies with poor pathogen removal characteristics (but they were never designed to have them--see section 8.2). A removal ability of less than 99 percent means always more than 1 percent survival or always less than a 2 log unit reduction. Where incoming wastes have high concentrations of pathogens, as may often be the case with viruses, bacteria, and protozoa (Table 10), a survival of more than 1 percent is usually not adequate in developing countries.

When considering treatment technologies in terms of their ability to remove pathogens, it is necessary not to dwell on trivial differences, as between 92.3 percent removal and 97.8 percent removal, but to look at orders of magnitude. Conventional treatment works remove between 1 and 2 log units of enteric bacteria and should be contrasted with technologies, like waste stabilization ponds, which remove 5 or more log units. When considering technologies, like stabilization ponds or thermophilic digesters, with very high removal performance, it is also misleading to talk in terms of percentage removal. Use of this convention disguises, for instance, the important difference between 99.99 percent removal and 99.999 percent removal.

The removal characteristics of treatment technologies should be related to the incoming concentrations of particular pathogens, to the intended reuse or disposal arrangements, and to the associated health risks. Different pathogens occur in very different concentrations and are affected in different ways by a given treatment technology. For instance, protozoa will be found in raw sludge in relatively low numbers and will not survive any sludge treatment process. By contrast, Ascaris ova may be found in sludge in high concentrations and will survive most sludge treatment processes (see section 10.39).

8.2 APPROPRIATE PHILOSOPHIES REGARDING NIGHT-SOIL AND SEWAGE TREATMENT

The primary objective in the treatment of night soil or sewage from communities in which excreted infections are endemic is the destruction of excreted pathogens. This is principally achieved by a combination of time and temperature, although other conditions of the extra-intestinal environment are also important, for example, sunlight and oxygen tension.

It appears from our extensive literature review (see Feachem et al., forthcoming) that no excreted pathogen can survive a temperature of more than 65°C for a few minutes, with the exception of spore-forming bacteria (for example Clostridium perfringens) and hepatitis A virus. As the temperature falls, survival increases; thus, for instance, at 20°C Ascaris ova may survive for several years, enteroviruses for twelve months, and shigellae for two to three months. Further information on the survival of excreted pathogens in the environment outside the intestine is given in chapter 7.

The degree to which night soil and sewage are treated is largely influenced by what is to be done with the sludge, compost, or sewage effluent. Thus it is accepted engineering practice to discharge untreated sewage to sea provided the outfall is designed to ensure that no pollution of beaches or shellfish growing areas occurs. If it is intended to reuse an effluent for the irrigation of edible crops, the designer's goal should be the absence of excreted pathogens on the surface of the crops and he should accordingly design the treatment works for a very low degree of pathogen survival. Treatment strategies for different reuse and disposal practices are discussed in chapters 11 and 12.

Excreta and night-soil treatment

The effectiveness of excreta and night-soil treatment methods depends very much upon their time-temperature characteristics. The effective processes are those that either make the excreta warm (55°C), hold it for a long time (one year), or feature some effective combination of time and temperature.

Pit latrines (section 9.2) have a useful life of a few years; when one becomes full, a second is dug and the contents of the first are left undisturbed while the second is in use. Because of the time interval there need be no health hazards associated with digging out the contents of previously filled and covered pit latrines. Provided the squatting plate is regularly cleaned, pit latrines pose no greater risks to health than do flush toilets, though insect breeding can be a serious problem and odors can be a nuisance.

Composting toilets are of two types: batch and continuous (section 9.3). If the composting period is over one year, only a few Ascaris ova will be present in the product. With a composting period of under one year, varying numbers of other excreted pathogens will be present, as shown in Table 18.

Table 18. Pathogen Content Anticipated in Final Product of Anaerobic Composting Toilets Operating at Ambient Temperatures in Warm Climates

Pathogen	Retention Time (Months)						
	1	2	3	4	6	8	10
Enteric viruses	+	+	0	0	0	0	0
Salmonellae	+	+	0	0	0	0	0
Shigellae	+	+	0	0	0	0	0
<u>Vibrio cholerae</u>	+	0	0	0	0	0	0
Path. <u>E. coli</u>	+	+	0	0	0	0	0
<u>Leptospira</u>	0	0	0	0	0	0	0
<u>Entamoeba</u>	0	0	0	0	0	0	0
<u>Giardia</u>	+	+	0	0	0	0	0
<u>Balantidium</u>	+	0	0	0	0	0	0
<u>Ascaris</u>	++	++	++	++	+	+	+
<u>Trichuris</u>	++	++	+	+	+	+	0
Hookworms	+	+	0	0	0	0	0
<u>Schistosoma</u>	0	0	0	0	0	0	0
<u>Taenia</u>	++	++	++	++	+	+	+

Legend:

0 Probable complete elimination.

+ Probable low concentration.

++ Probable high concentration.

Thus, composting toilets have definite health risks that, even though they may be slight, should at least be recognized by the designers and users of such systems. In strictly economic terms the value of the compost needs to be greater than the cost to health that results from its use.

The health hazards associated with the collection of night soil from bucket and vault latrines are described in section 9.4. If urine is collected as well as feces, the night soil is a fecal suspension similar to primary sewage sludge and may be treated by batch anaerobic thermophilic or mesophilic digestion. It may also be treated in a pond system, which can be designed to have little effluent so that very long retention times are possible (one year). Consequently, no excreted pathogens will survive. If the urine is not collected and is allowed to drain away in an on-site soakage pit, the night soil (now principally feces) may be disposed of, treated, and reused in a number of ways (sections 9.4 and 9.5). Night-soil cartage and treatment systems will tend to have higher health risks than many other systems, although these can be very much reduced by the use of modern methods (such as are found in Japan). In high density urban settings, where the only technical alternative may be a sewerage system, cartage systems will often be economically attractive despite their health problems. In other settings, where a greater range of technologies are feasible, they may be less attractive.

Sewage treatment

Those whose job it is to select and design appropriate systems for the collection and treatment of sewage in developing countries must bear in mind that European and North American practice does not represent the zenith of scientific achievement, nor is it the product of a logical and rational design process. Rather, developed country practice is the product of history, a history that started about 100 years ago when little was known about the fundamental physics and chemistry of the subject and practically none of the relevant microbiology had been discovered. Only in the last decade have we developed the tools to do serious work in water and wastewater virology, and it is only in the last five years that the role of excreted rotaviruses and pathogenic E. coli in the etiology of infant diarrheas has been demonstrated.

The development of European and North American sewerage systems can be roughly summarized as follows:

- (i) a growing awareness of squalor in the large cities, and the consequent risks to health, led to the construction of sewers that discharged raw wastes into rivers (in the mid-nineteenth century in London, for instance);
- (ii) this resulted in massive pollution and oxygen depletion in the rivers, which often became foul, open sewers;
- (iii) various forms of treatment technology were developed to reduce the suspended load and the oxygen demand of the discharged wastes (for example, the U.K. Royal Commission on Sewage Disposal [1899-1915] proposed effluent standards of 30 milligrams per liter suspended solids and 20 milligrams per liter BOD);

- (iv) in the 1950's and 1960's a growing awareness of environmental problems, coupled with a now greatly increased population, led to tertiary treatment processes being introduced to further protect receiving waters from oxygen depletion, toxic substances, and eutrophication; and
- (v) at the same time it became clear that these sophisticated treatment technologies were not efficient at removing pathogenic microorganisms. Thus, in countries where environmental concern was very acute (e.g., the U.S.A.), or where effluents were commonly reused (e.g., Israel), effluent chlorination was borrowed from the water treatment industry as a way of killing bacteria, and possibly viruses, in the effluents. This technology, however, brought with it new and different environmental concerns (see section 10.7).

This short (and highly simplified) account illustrates the historical and conservative nature of the development of current practice in industrialized countries. It is not especially clever, nor logical, nor completely effective, and it is not necessarily what would be done today if these same countries had the chance to start again.

Fluid retention in conventional sewage treatment works, oxidation ditches, and aerated lagoons treating domestic sewage are commonly less than one, three and six days, respectively. Septic tanks typically have retention of one to three days. These short retention times in conjunction with temperatures that rarely exceed 35°C result in very high pathogen survivals, and the full range of excreted pathogens present in the raw sewage appear in the effluent. The sludge produced in conventional sewage treatment works and oxidation ditches also contains the full range of excreted pathogens and requires some form of treatment before disposal or reuse. Dewatering to a moisture content of 80 percent is all that is required if the sludge is to be landfill. If it is to be reused in agriculture, effective sludge treatment for pathogen destruction is required.

The conventional sewage treatment works were originally developed in order to prevent gross organic pollution in European and North American rivers; they were never intended to achieve high removals of excreted pathogens. Their use in tropical countries in which excreted infections are endemic is only justifiable in special circumstances, as there is now an alternative treatment process that is vastly superior in obtaining low survivals of excreted pathogens.

This alternative process is the waste stabilization pond system, which is described in section 10.8. The retention times commonly encountered in properly designed pond systems are twenty-five days and this, in conjunction with such environmental factors as sunlight and the presence of algal toxins, is responsible for the ability of pond systems to produce very low survivals of excreted pathogens; indeed protozoa and helminth ova and larvae can be completely eliminated from the effluent. Pond systems have several other advantages over other treatment methods: they are the cheapest form of

treatment, both to construct and operate, with minimal or no requirements for foreign exchange; their maintenance is very simple, requiring only unskilled labor; they are easily designed to achieve any required degree of treatment, and the algae produced in the ponds are a potentially valuable source of protein (see section 11.3).

CHAPTER 9

HEALTH ASPECTS OF EXCRETA AND NIGHT-SOIL SYSTEMS

9.1 INTRODUCTION

In chapters 9 and 10 we consider the health implications of the main varieties of excreta collection and treatment systems. We separate these into the "dry," or night-soil, systems and the "wet," or sewage, systems. In chapters 11 and 12 we consider the health implications of reuse and disposal practices. In these chapters we pay little attention to the technical details of the systems considered, except insofar as these bear on specific health problems. The reader wishing more information on technical aspects should refer to the companion document published by the International Development Research Centre (Rybczynski, Polprasert, and McGarry, 1978), Albermatten et al. (forthcoming), and standard sanitary engineering texts.

In this chapter we describe three varieties of excreta or night-soil systems: the pit latrine and its various modifications, the composting latrine, and the cartage system. We conclude with a discussion on the health applications of night-soil treatment by composting.

9.2 PIT LATRINES

Technical description

Pit latrines are the simplest of all on-site disposal systems. Excreta fall into a hole in the ground and a new pit is dug when the hole is about two-thirds full (Figure 5). A vented pit latrine, and a modified pit latrine called a ROEC (Reed Odorless Earth Closet), are shown in Figures 6 and 7. Pits are covered by squatting slabs, seats, or pour-flush bowls.

Cleanliness

As with all latrines, cleanliness is of the utmost importance. Squatting slabs easily become fouled and pour-flush bowls may block up. Fouled and unhygienic pit latrines are found all over the world, often because they have been constructed in communities that previously used the open ground for defecation and in the absence of adequate community involvement or education. Fouled pit latrines become a focus for disease transmission and may take matters worse than before.

Smell

Pit latrines with squatting slabs often smell. If they smell they may not be used and thus cannot achieve any potential benefits in improving health. Smell can be virtually eliminated by fitting a vent pipe to the pit. This pipe should be at least 100 millimeters in diameter, (preferably 100-200 millimeters), painted black, and fitted on the sunny side of the latrine so it can heat and so create an updraft.

Figure 5 - Section of a Pit Latrine
(millimeters)

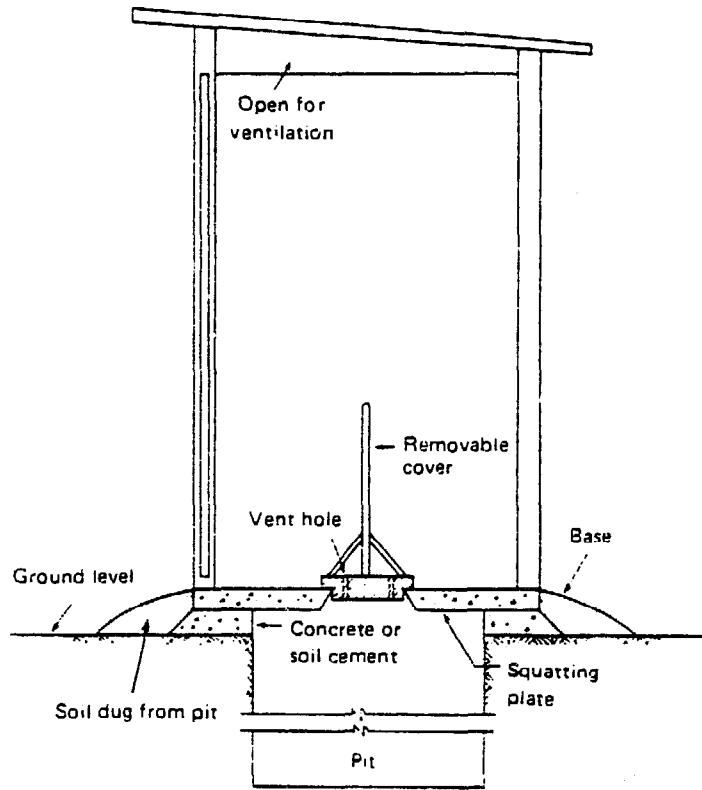

Side view

Source: Feachem and Cairncross (1978).

Figure 6 – Vented Improved Pit (VIP) Latrine
(millimeters)

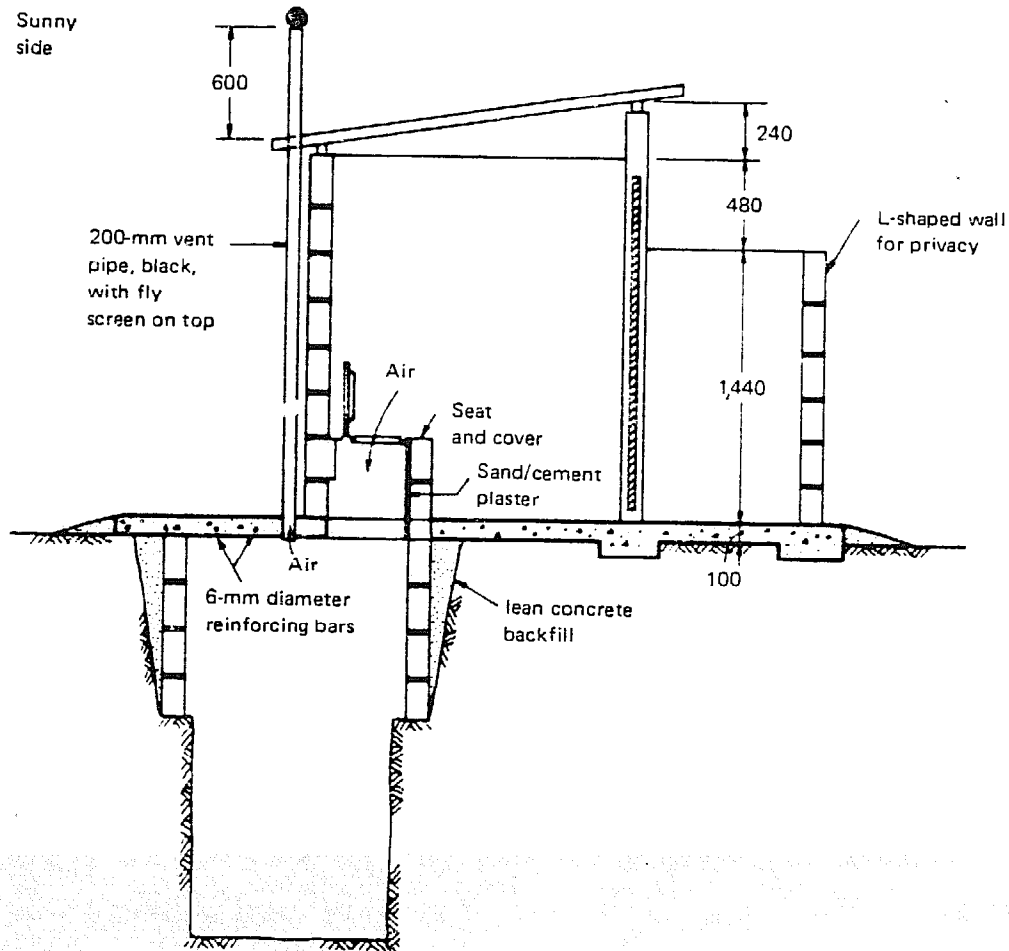

Source: Feachem and Cairncross (1978).

Figure 7- ROEC Pit Latrine
(millimeters)

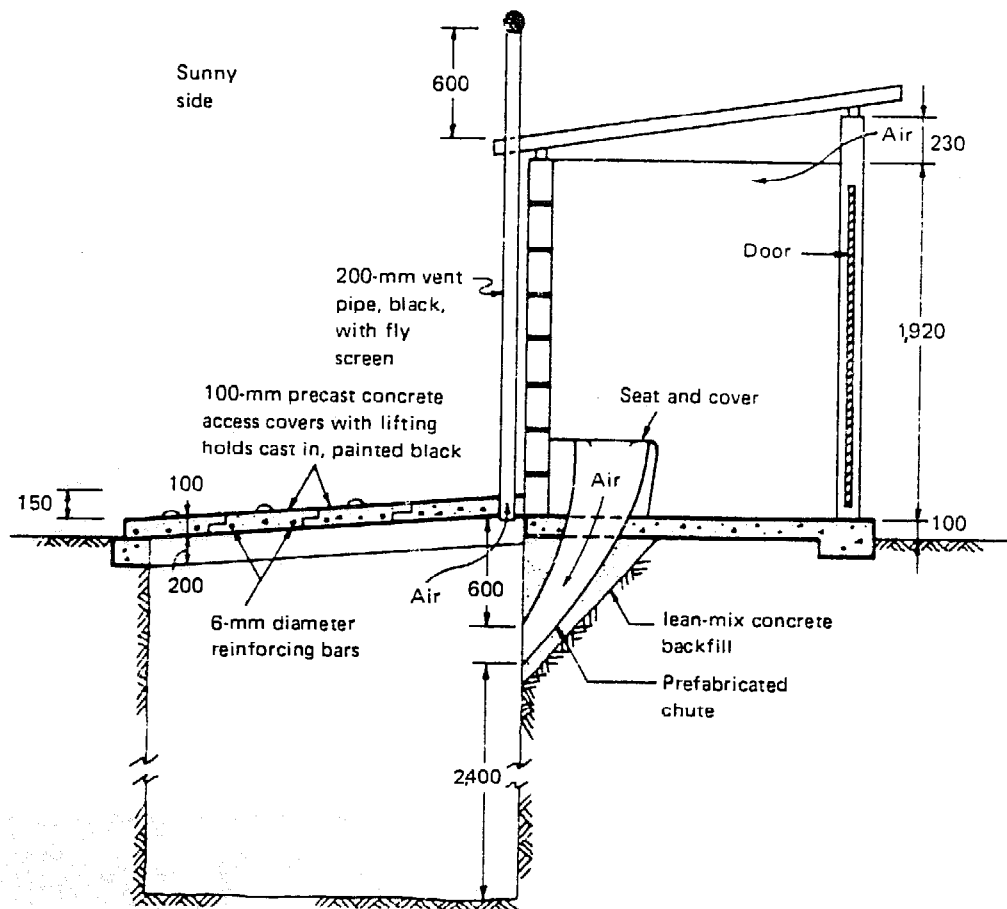

Source: Feachem and Cairncross (1978).

Insect breeding

Pit latrines with squatting slabs will usually become breeding sites for flies. Flies that visit a pit latrine to breed or feed may carry pathogens when they leave and can thus promote disease transmission. If the pits are wet they may also become the breeding sites of Culex pipiens. Well-constructed pits with pour-flush bowls will not allow any fly or mosquito breeding. If squatting slabs are used, a completely vertical vent pipe of at least 150-millimeter diameter, covered by a fly screen, combined with a dark interior to the superstructure, will greatly reduce the amount of fly breeding and the escape of any flies that do breed. Flies breeding in the pit will be attracted by the light coming down the ventilator and will attempt to escape by this route, only to be prevented by the fly screen. The effect of large diameter vent pipes on mosquito breeding in wet pits remains unclear. Note that the minimum vent pipe diameter needed for odor control (100 millimeters) is less than that for insect control (150 millimeters) because the function of the former is to cause a draft, while that of the latter is to let in light. Further research is required on the optimal design of vent pipes for pit latrines.

Pathogen survival in the pit

Most pit latrines are filled in when two-thirds to three-quarters full and are either never dug up or only dug up many years later. In this case pathogen survival is of no interest because all pathogenic organisms will be dead. In some areas, however, two alternating pit sites are used and a pit is dug out a year or two after closing and the contents are used as fertilizer. This system resembles the double-vault composting toilet (see below) except that it operates on a very long cycle. If the pit has been left for a minimum of one year, there will be no viable pathogens surviving except for the possibility of a few Ascaris ova. The chances of viable Ascaris ova being present are greater if the pit is wet and partly below the water table. The risk involved in reusing material that has been buried for at least twelve months is very small, however, and the pit contents may be immediately used on the field with confidence.

Groundwater pollution

This is a real hazard in areas where pit latrines are widely used and where the groundwater is high and is used as a water source. The subject is discussed in section 12.3.

9.3 COMPOSTING TOILETS

Technical description

There are two main types of composting toilets--continuous and batch. Both types require the addition of a carbon source such as garbage, vegetable leaves, or sawdust. The continuous composting toilets are based on the Swedish "multrum" toilets and a good example of such a design is shown in Figure 8. They have been under trial in Tanzania and Botswana for over a year at the time of writing (early 1978) but have had no wide-scale application in developing countries. Only very limited and inadequate

Figure 8 - 'Multrum' Style Continuous Composting Toilet
(millimeters)

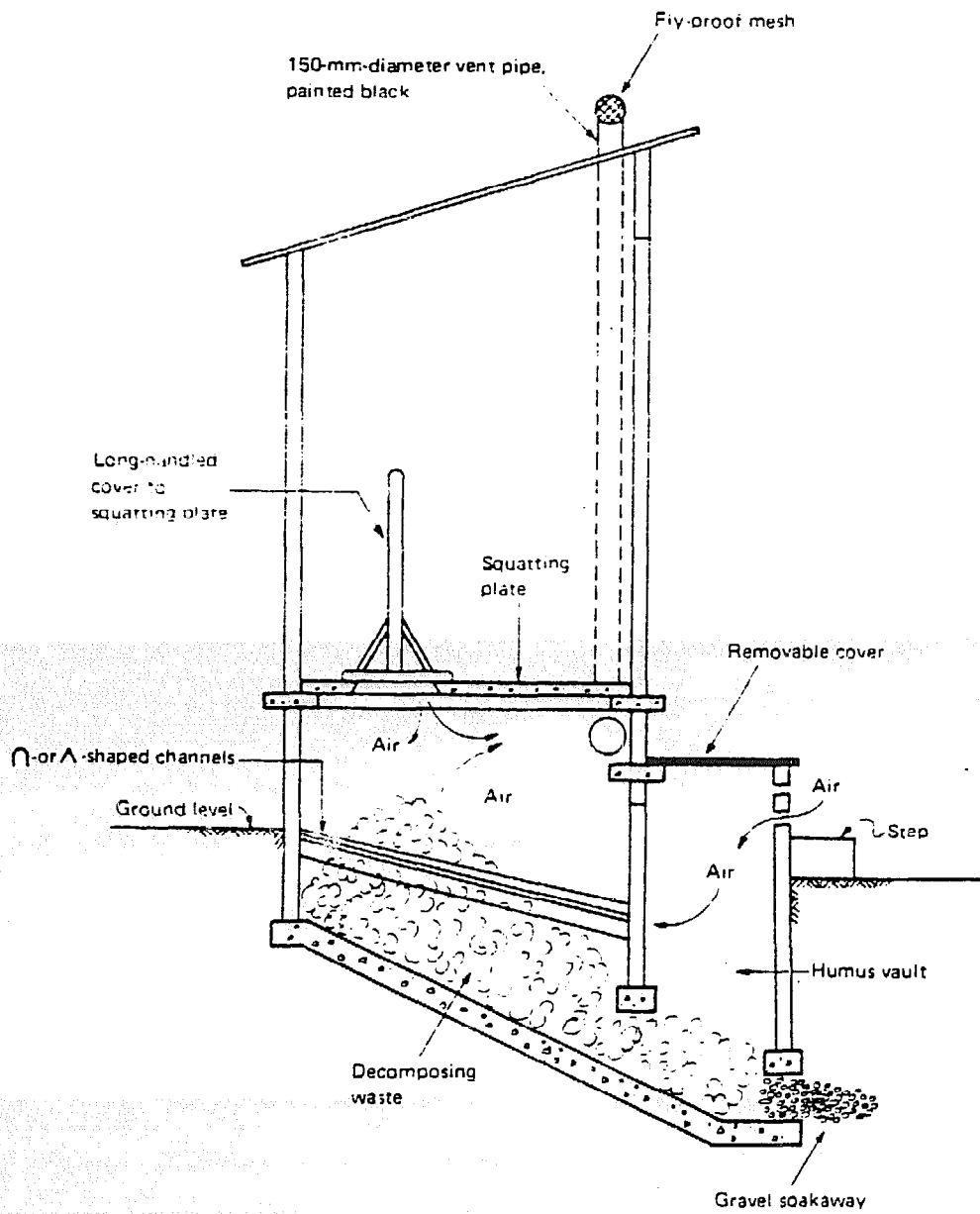

Source: Adapted from Wagner and Lanoix (1958).

Figure 9— Single-family, Double-vault Composting Latrine
(millimeters)

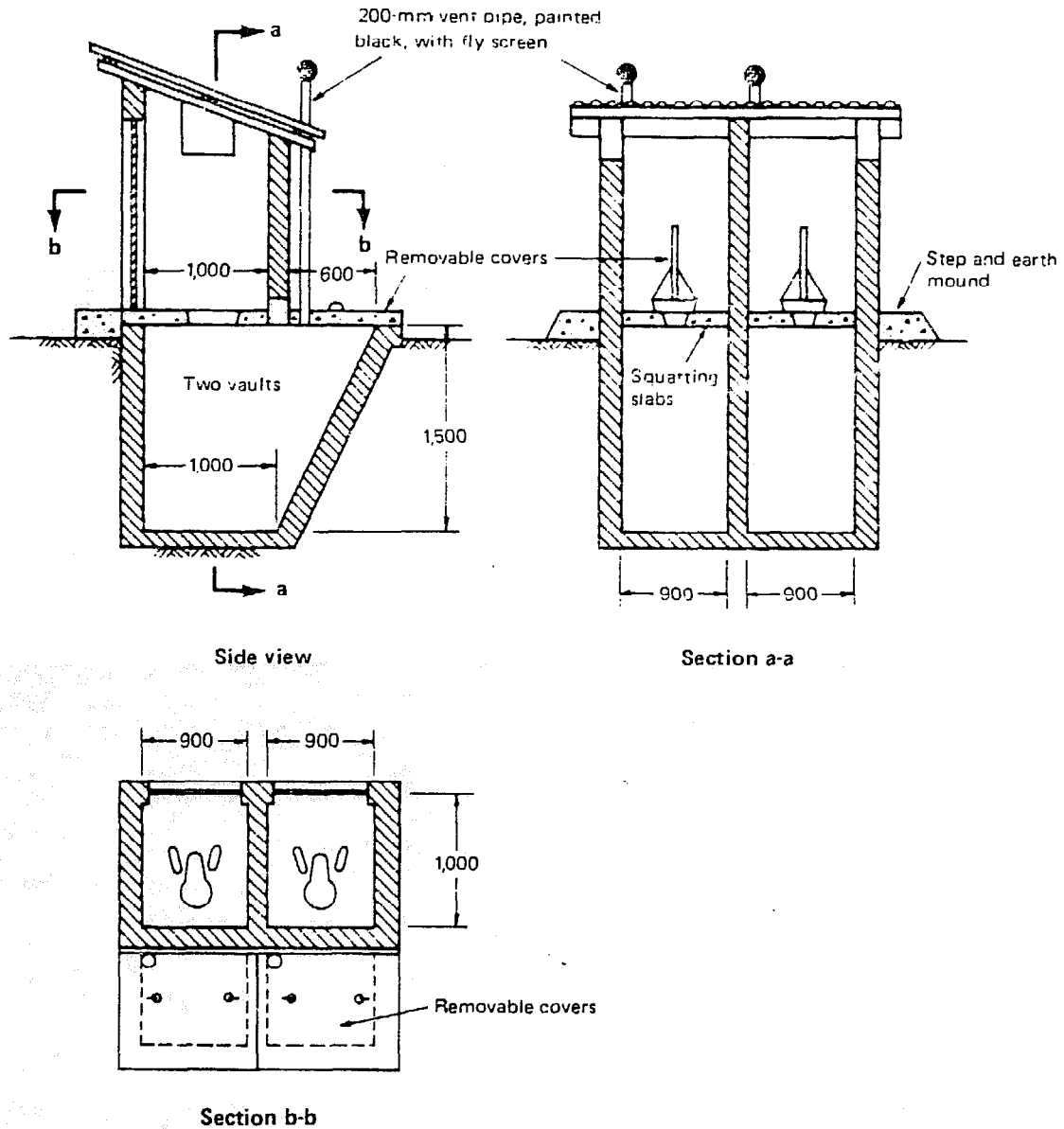

Source: Feachem and Cairncross (1978).

microbiological data exist on continuous composters (Gurak, 1978; reviewed by Feachem, Mara, and Iwugo, 1978). The batch type is common in China and Vietnam and the most usual design is the double vault shown in Figure 9. Again no worthwhile microbiological data on these toilets have been located, although such data may exist in China and Vietnam.

Pathogen survival

In both types of composting toilet, the product of the toilet is used as an agricultural fertilizer and soil conditioner. It is important, therefore, that pathogen destruction should be as complete as possible. The two factors that most affect the survival of excreted pathogens are time and temperature. Temperature depends on the air supply, the C/N ratio, and the moisture content. If the digestion is anaerobic, the temperature may remain ambient or it may rise at most to around 50-70°C range if the C/N ratio and moisture content are correctly regulated. These conditions may be difficult to achieve, especially in arid developing countries where little waste organic material is found.

It is certain that double-vault composters will be anaerobic and it is probable that multrums will be also. Certainly, anaerobicity and ambient temperature are the correct conservative assumptions to make where pathogen removal is concerned. Pathogen removal depends then on the retention time in the unit. Since there appears to be a wide variation in retention time used in both the multrum (continuous) and double-vault (batch) systems, Table 18 has been provided to permit the pathogen removal efficiency of any given design to be estimated. It is clear from Table 18 that a minimum retention time of three months will produce a product free of all pathogens except the more persistent helminth ova. This position is visually summarized in Figure 10. Three possible control strategies could be adopted:

- (i) to use the compost as produced and accept the level of risk involved. This risk could be reduced to very low levels by using the compost only to prepare the ground prior to planting or at least by not applying compost within two months of harvesting;
- (ii) to apply the compost only to industrial or fodder crops; or
- (iii) to provide further treatment for the compost by heating (probably impracticable) or by mixing with an ovicide (often also impracticable).

The first of these strategies is probably the most realistic and the quality of the product will become better as the retention time is increased above three months.

9.4 CARTAGE SYSTEMS

Technical description

Cartage systems refer to a variety of technologies in which night soil is periodically removed from containers in or near the house. One of the oldest and generally least hygienic systems is the bucket latrine. A

Figure 10 – Pathogen Flow through a Batch Composting Toilet (double-vault)

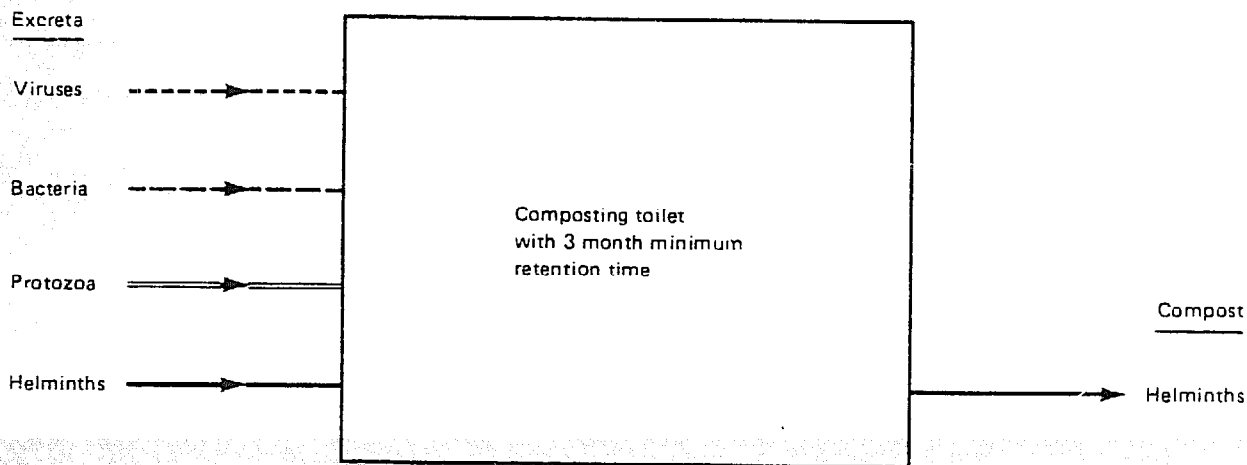

squatting slab or seat is placed immediately above the bucket, which is filled within a few days by the excreta of an average family (Figure 11). The bucket is positioned adjacent to an outside wall and is accessible from the street or back lane. A night-soil collector ("scavenger" or "sweeper") will call regularly--preferably every day but more typically once or twice a week--to empty the bucket.

Many households in Japan, Taiwan, and other countries store their excreta, plus the small amounts of water used for pour-flushing and anal cleansing, in sealed vaults under or beside the house (Figure 12). These vaults are emptied about once every two weeks by a vacuum truck. This system has relatively high operating costs but may have relatively low initial costs. It is suitable for high density urban areas where access by truck is possible and truck maintenance facilities exist.

The health dimensions of a cartage system depend on the manner in which the night soil is deposited, collected, transported, treated, and reused. These will be considered in turn.

Night-soil deposition

The two normal methods are the bucket or vault. Both of these can be satisfactory if they are hygienically maintained. The bucket, being a smaller vessel, is more likely to overflow and to contaminate its surroundings. Also, the bucket latrine is almost certain to be odorous and this will discourage use. In contrast, the vault can be ventilated and can be a very hygienic and pleasant latrine.

The possibility of fly breeding depends on the frequency of emptying. House flies and blow flies require a minimum of eight days to develop from egg to adult, so a bucket emptied every seven days would not permit fly breeding, provided it was well cleaned each time it was emptied. Vaults, on the other hand, are emptied less frequently and fly breeding is a danger. This can be reduced by having a pour-flush water seal to prevent access for adult flies or having a vent pipe with a fly screen similar to that recommended for pit latrines (section 9.2). A pour-flush water seal is probably the only reliable method of preventing fly breeding in vault latrines.

Night-soil collection

Collection by vacuum trucks from vaults can be a hygienic and risk-free operation provided that the outlet pipe from the vault is in good repair and that all the fittings on the truck and suction hose are well maintained. A little spillage is probably inevitable, but it can be reduced to an acceptable minimum by good equipment and well-trained personnel operating the truck.

Bucket-latrines collection, by contrast, is always messy. The worst arrangement is to empty the buckets and immediately return them. This will cause the bucket latrine area to become progressively more fouled. Emptying the bucket, rinsing it out, and returning it is also undesirable and will probably result in the material washed off, or the washwater itself, being deposited in the street. The best arrangement is to replace the bucket by

Figure 11— Bucket Latrine with Squatting Slab
(millimeters)

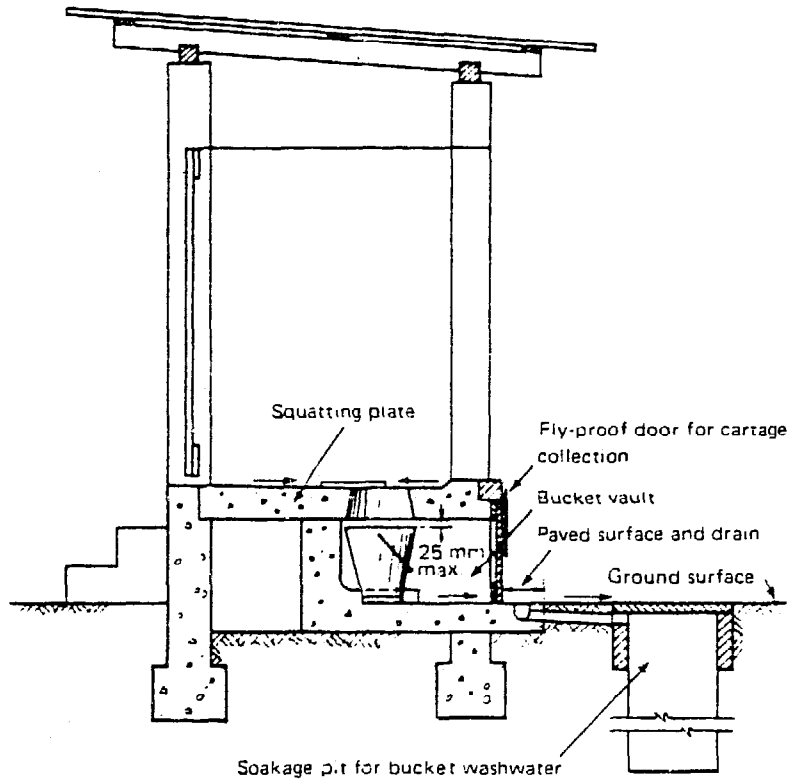

Bucket latrine

Source: From Wagner and Lanoix (1958).

Figure 12— Household Night-soil Collection (with vault and vacuum truck)

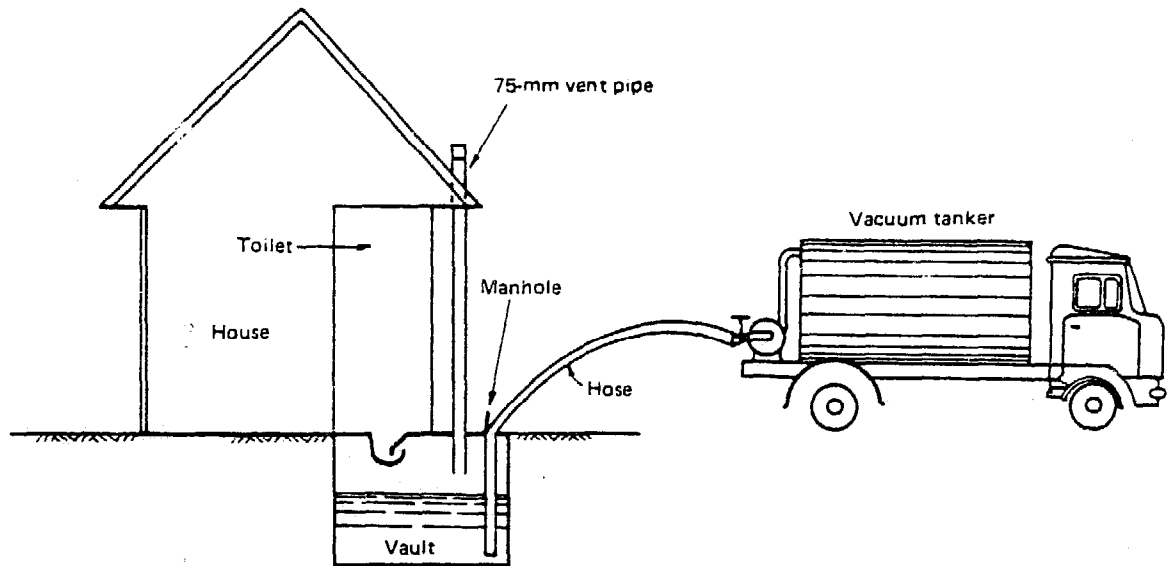

Vault below squatting place

Source: Pradt (1971).

another cleaned and disinfected one. Dirty buckets are then returned to a central depot for cleaning and disinfection. This system is helped by a color code in which all buckets collected on Monday are, for example, red, and the replacement buckets green.

This bucket replacement system, however, is often not feasible on a large scale because of the difficulty in transporting large numbers of buckets. It can, however, work in army camps, prisons, disaster relief camps, and other institutions of limited size.

It is clear that the risks from a cartage system depend very greatly on the quality and regularity of the service provided. The system is very sensitive to a few days interruption in collections, whether due to mechanical breakdown or absence of the sweeper (see chapter 13).

Night-soil transportation

The differences in health risks between the alternative systems become most apparent at the transportation stage. The worst system is the one in which buckets are emptied by hand into open carts or into larger buckets that are carried by hand or on yokes. Under these arrangements there will always be spillage. People who come into contact with this fresh night soil risk infection from any of the nonlatent pathogens (categories I and II, Table 14). This risk is not simply to the sweepers themselves, but also to anyone who walks, plays, or works in the street or back lanes where the night soil has been spilled. The risk to children is obviously very high since they commonly play in the back lanes. The latent pathogens that develop on the soil (hookworms, Ascaris, and Trichuris) may well develop where they are spilled and so subsequently infect people in the street or alley. There is evidence that the cartage of night soil is partly responsible for the high levels of soil contamination with Ascaris ova found in some cities.

Vacuum trucks, by contrast, can transport night soil through the streets with minimal risk of spillage.

Night-soil treatment

Night-soil treatment is mainly dealt with in other sections of this book. Night soil can be digested and dewatered like sludge (see section 10.3), mixed with sewage and treated in conventional plants (see section 10.3), or sluiced into waste stabilization ponds (see section 10.8).

Quite commonly night soil is buried in trenching grounds. Rarely is the alternative of reuse rigorously considered (chapter 11). Where trenching is used the health implications can be very serious. A badly managed and inadequately controlled trenching ground will be a major health hazard to all who work on it or to those, such as children, who may gain access. The families and close contacts of these people are also at risk. The proper management of a trenching ground is largely a matter of common sense. Trenches should be at least 0.6 meters deep and should be filled with night soil to a depth of not more than 0.3 meters. They should then be rapidly covered with tamped earth, a small mound of earth made over the

trench, and left for at least two years. Yet, however well-managed a trenching ground is on the surface, the risk of groundwater pollution may always be present (see section 12.3). This risk is minimized by careful location of the trenching ground following a hydrogeological survey.

In many situations, the most appropriate and attractive method of night-soil treatment is by mixing with refuse and composting. Composting is dealt with below in section 9.5.

Night-soil reuse

Reuse is described in detail in chapter 11. The reuse of untreated night soil in agriculture is a widespread practice but one that is to be strongly condemned from a health point of view. There is much evidence that the use of untreated night soil on crops contributes to the transmission of infection to those working in the fields and, to a lesser (but still significant) extent, to those handling or consuming the crops. Treatment or storage of night soil should therefore always be provided prior to its reuse.

9.5 COMPOSTING

Technical description

As we reiterate many times in this book, temperature and time are the two most important factors in the achievement of low pathogen survival in waste treatment processes. In the treatment of night soil or sludge for reuse, an almost pathogen-free product is required. This is only achieved by processes incorporating long retention times (such as ponds, section 10.8, or protracted digestion and drying, section 10.3) or by processes that heat the waste (such as thermophilic digestion, section 10.3, or thermophilic composting). It is thermophilic composting that we discuss here. The attraction of thermophilic composting is that it can provide a safe reuse product in a relatively short time (two months) and that it does not require an external source of energy to heat. In addition, composting technologies are available that are relatively low cost and labor intensive. The compost produced is a useful soil conditioner and source of plant nutrients and may be increasingly in demand amongst poor farmers as the cost of industrially produced fertilizers rises (Food and Agricultural Organization, 1975).

Composting has been thoroughly reviewed by Gotaas (1956) and a more recent account is provided by Shuval (1977a). A wide range of fecal composting technologies is available. They all incorporate the mixing of night soil or sludge with a carbon source such as refuse or sawdust to achieve a C/N ratio of approximately 20-30. Moisture content (20-60 percent) must also be regulated for optimal performance with wetting or turning (to dry) at appropriate intervals.

The most important feature of composting, from the health viewpoint, is the temperature achieved, and this depends on the oxygen content of the pile, as well as the C/N ratio, the moisture content, particle size, and pH. If the process is anaerobic, temperatures will remain at, or only a little

above, ambient and mesophilic organisms will predominate. Foul smelling gases are usually produced and the process of degradation proceeds slowly. If the process is aerobic, substantial heat is generated by proliferating thermophilic microorganisms and degradation is more rapid and usually free of odor.

A compost pile, newly erected, will contain entrapped oxygen and, if other factors mentioned above are correctly regulated, thermophilic aerobic processes will be established and the temperature at the center of the pile will rapidly rise to 55°C or above. As the available oxygen is used up, however, the process will become progressively more anaerobic and temperatures will fall. There are three methods commonly used for keeping up the supply of oxygen and, therefore, maintaining thermophilic temperatures: the pile is regularly turned, ventilation tubes are arranged in the pile, or forced aeration is provided with blowers or suckers. In the last two cases, the pile is usually lagged to prevent heat loss. In these well-managed thermophilic aerated composting systems, temperatures can rise to 80°C and it is possible to ensure that all parts of the pile spend several hours at above 60°C. This has the utmost significance for pathogen survival, as will now be discussed.

Pathogen survival

Pathogen survival in compost systems depends upon the time-temperature characteristics of various parts of the pile. In Figure 13 we have overplotted the death curves for some pathogens. For each pathogen, time-temperature points above the curve represent certain total destruction. It is clear that enteric viruses and Ascaris ova are the most hardy, but the following time-temperature combinations will guarantee their destruction: one hour at 62°C; one day at 50°C; one week at 46°C; or one month at 43°C. Therefore, if all parts of a compost pile can be brought to a time-temperature state within the zone of safety on Figure 13, complete pathogen destruction should be guaranteed. This position is summarized visually in Figure 14. There are two possible exceptions to this; first, spore-forming bacteria (such as Clostridium perfringens, see section 6.3) are more resistant but present little risk and, second, hepatitis A virus appears to be resistant to rapid heating to temperatures of up to 100°C, but its ability to survive temperatures only slightly above 60°C for several hours is not known.

Much of the literature on pathogen survival in compost, which has been reviewed previously by others (for instance, Kawata, Kramer, and Burge, 1977; Krige, 1964; Reeves, 1959; Shuval, 1977a; Wiley, 1962; Wiley and Westerberg, 1969). This literature indicates that a well-designed system under good management produces a pathogen-free, or almost pathogen-free, compost. Where some sections of the pile do not reach the required temperature for the required time, however, there will be pathogen survival. The organism most likely to survive is Ascaris and therefore Ascaris ova may be used as the indicator of successful composting (see section 6.5). Appendix VII summarizes the literature.

Figure 13 - Influence of Time and Temperature on Selected Pathogens in Night Soil and Sludge

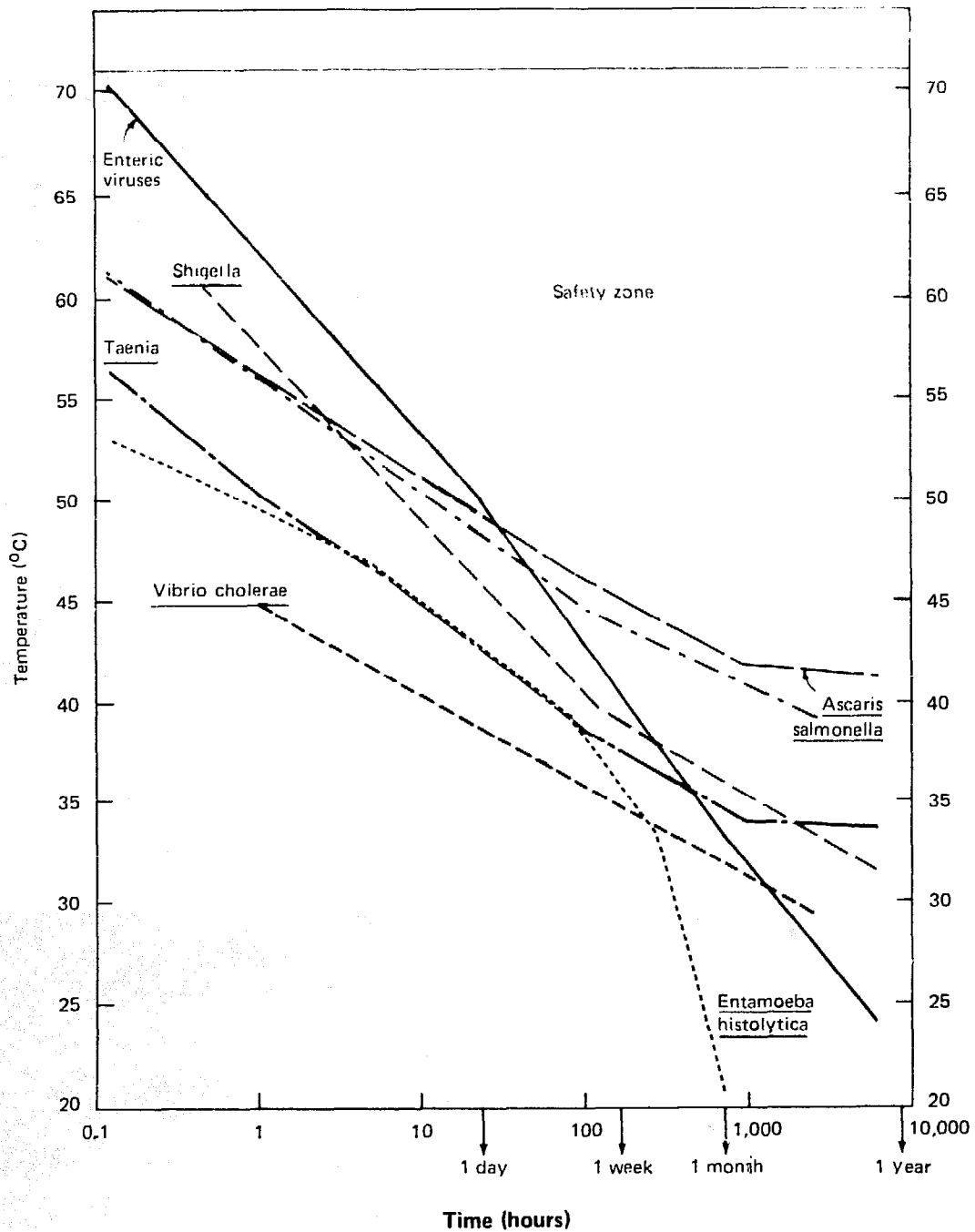

Note: The line represents conservative upper boundaries for pathogen death--that is, estimates of the time-temperature combinations required for pathogen inactivation. A treatment process with time-temperature effects falling within the "safety zone" should be lethal to all excreted pathogens (with the possible exception of hepatitis A virus--not included in the enteric viruses in the figure--at short retention times). Indicated time-temperature requirements are at least: 1 hour at $\geq 62^{\circ}\text{C}$, 1 day at $\geq 50^{\circ}\text{C}$, and 1 week at $\geq 46^{\circ}\text{C}$.

Source: Feachem and others, Sanitation and Disease.

Figure 14. Pathogen Flow through Well-managed Thermophilic Composting Process

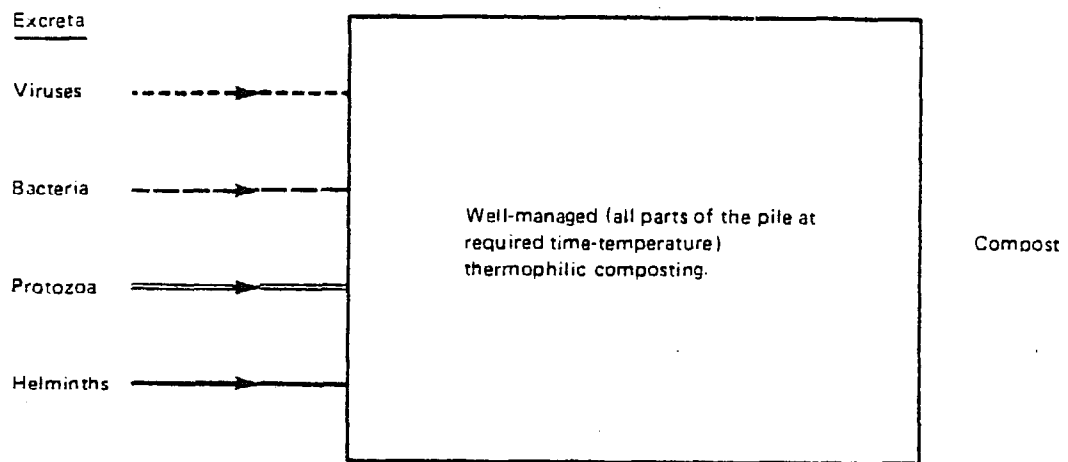

Fly breeding

One of the major problems in compost management is fly control. Apart from the fact that flies are a nuisance to people and animals, they are capable of carrying pathogenic organisms and may thus transmit diseases. All raw materials used for composting attract flies and are good media for fly breeding. Eggs can be laid in the material at the place of collection or during the handling of the material at the compost site. Different species of flies are predominant under different conditions, but good control measures should affect them all in a comparable manner.

Fly larvae cannot survive temperatures above 51°C, so, as with pathogens, the achievement of high temperatures in all parts of the pile is the essential requirement for fly control. Fly larvae may migrate along temperature gradients to seek out the cooler parts of the pile, such as the edges or the ventilation shafts. These larvae may be destroyed by effective and well-controlled turning or by the lagging of unturned piles. The use of insecticides in compost piles is not desirable unless it has been demonstrated that such chemicals will not affect the composting process or the acceptability of the product to farmers.

In general, fly breeding may pose a problem in all composting systems. The level of fly breeding provides some gauge of how successfully the pile is managed and whether it is being thoroughly heated. Minimum fly breeding should therefore be an explicit management goal in all composting plants. It is possible to monitor the level of fly breeding by positioning fly traps at appropriate sites around the plant and recording the daily catch. This provides an ongoing and immediate check of management and temperature control that the staff in charge could find most useful. Fly breeding will, of course, fluctuate markedly with the seasons, irrespective of the condition of the compost pile.

9.6 SUMMARY

Some of the information in this chapter is summarized in a comparative form in Table 19.

Table 19. Summary of Pathogen Removal by Various Sewage Treatment Processes

Organisms	Parameters	Primary Sedimentation	Trickling filter with primary and secondary sedimentation, sludge digestion, and sludge drying	Activated sludge with primary and secondary sedimentation, digestion, and sludge drying	Oxidation ditch with sedimentation and sludge drying	Waste stabilization ponds. 3 cells. Minimum total retention time = 25 days	Septic tanks	Lagoo-tertiary treatment
Enteric viruses	Typical inflow	$10^3-10^5/l$	$10^3-10^5/l$	$10^3-10^5/l$	$10^3-10^5/l$	$10^3-10^5/l$	$0-10^9/l$	$10-10^{10}/l$
	Typical outflow	$10^3-10^5/l$	$10^2-10^4/l$	$10-10^4/l$	$10-10^4/l$	$0-10/l$	$0-10^8/l$	$0-10^9/l$
	Percent removal	0-30%	90-95%	90-99%	90-99%	99.99-100%	50%	99-100%
	Final sludge	Contaminated	Contaminated	Contaminated	Contaminated	—	Contaminated	—
Salmonellae	Typical inflow	$10^3-10^4/l$	$10^3-10^4/l$	$10^3-10^4/l$	$10^3-10^4/l$	$10^3-10^4/l$	$0-10^9/l$	$10-10^{10}/l$
	Typical outflow	$10^2-10^3/l$	$10^2-10^3/l$	$10-10^3/l$	$10-10^3/l$	$0-1/l$	$0-10^8/l$	$0-10^9/l$
	Percent removal	50-90%	90-95%	90-99%	90-99%	99.99-100%	50-90%	99-100%
	Final sludge	Contaminated	Contaminated	Contaminated	Contaminated	—	Contaminated	—
Shigellae	Typical inflow	$10^3-10^4/l$	$10^3-10^4/l$	$10^3-10^4/l$	$10^3-10^4/l$	$10^3-10^4/l$	$0-10^9/l$	$10-10^{10}/l$
	Typical outflow	$10^2-10^3/l$	$10^2-10^3/l$	$10-10^3/l$	$10-10^3/l$	$0-1/l$	$0-10^8/l$	$0-10^9/l$
	Percent removal	50-90%	90-95%	90-99%	90-99%	99.99-100%	50-90%	99-100%
	Final sludge	Contaminated	Contaminated	Contaminated	Contaminated	—	Contaminated	—
E. coli	Typical inflow	$10^6-10^8/l$	$10^6-10^8/l$	$10^6-10^8/l$	$10^6-10^8/l$	$10^6-10^8/l$	$10^7-10^9/l$	$10^4-10^{10}/l$
	Typical outflow	$10^5-10^7/l$	$10^5-10^7/l$	$10^4-10^7/l$	$10^4-10^7/l$	$10-10^4/l$	$10^6-10^8/l$	$10-10^9/l$
	Percent removal	50-90%	90-95%	90-99%	90-99%	99.99-99.99999%	50-90%	99-99%
	Final sludge	Contaminated	Contaminated	Contaminated	Contaminated	—	Contaminated	—
Colera vibrio	Typical inflow	$10-10^3/l$	$10-10^3/l$	$10-10^3/l$	$10-10^3/l$	$10-10^3/l$	$0-10^9/l$	$0.1-10^{10}/l$
	Typical outflow	$1-10^2/l$	$1-10^2/l$	$0.1-10^2/l$	$0.1-10^2/l$	$0/l$	$0-10^8/l$	$0-10^9/l$
	Percent removal	50-90%	90-95%	90-99%	90-99%	100%	50-90%	99-100%
	Final sludge	Contaminated	Contaminated	Contaminated	Contaminated	—	Contaminated	—
Leptospirae	Typical inflow	Very few	Very few	Very few	Very few	Very few	Very few	Very few
	Typical outflow	Very few	Very few	Very few	Very few	0/l	0/l?	0/l
	Percent Removal	0%	0%	0%?	0%	100%?	100%	100%
	Final sludge	Safe	Safe	Safe	Safe	—	Safe	—
Entamoeba histolytica cysts	Typical inflow	$10-10^4/l$	$10-10^4/l$	$10-10^4/l$	$10-10^4/l$	$10-10^4/l$	$0-10^5/l$	$10-10^6/l$
	Typical outflow	$5-10^4/l$	$5-10^3/l$	$5-10^3/l$	$5-10^3/l$	$0/l$	$0-10^5/l$	$0/l$
	Percent removal	10-50%	50%?	50%?	50%?	100%	0%?	100%
	Final sludge	Contaminated	Safe	Safe	Safe	—	Contaminated	—
Hookworm ova	Typical inflow	$10-10^3/l$	$10-10^3/l$	$10-10^3/l$	$10-10^3/l$	$10-10^3/l$	$0-10^4/l$	$10-10^5/l$
	Typical outflow	$10-10^2/l$	$10-10^2/l$	$10-10^2/l$	$10-10^2/l$	$0/l$	$0-10^3/l$	$0/l$
	Percent removal	50%	50-90%	50-90%	50-90%	100%	50-90%	100%
	Final sludge	Contaminated	Contaminated	Contaminated	Contaminated	—	Contaminated	—
Ascaris ova	Typical inflow	$10-10/l$	$10-10^3/l$	$10-10^3/l$	$10-10^3/l$	$10-10^3/l$	$0-10^4/l$	$10-10^5/l$
	Typical outflow	$1-10/l$	$0-10^2/l$	$0-10^2/l$	$0-10^2/l$	$0/l$	$0-10^3/l$	$0/l$
	Percent removal	30-80%	70-100%	70-100%	70-100%	100%	50-9%	100%
	Final sludge	Contaminated	Contaminated	Contaminated	Contaminated	—	Contaminated	—
Schistosome ova	Typical inflow	$1-100/l$	$1-100/l$	$1-100/l$	$1-100/l$	$1-100/l$	$1-100/l$	$1-10/l$
	Typical outflow	$1-10/l$	$1-10/l$	$1-10/l$	$1-10/l$	$0/l$	$1-10/l$	$0/l$
	Percent removal	80%	50-9%	50-99%	50-99%	100%	50-90%	100%
	Final sludge	Contaminated	Safe	Safe	Safe	—	Contaminated	—
Taenia ova	Typical inflow	$1-100/l$	$1-100/l$	$1-100/l$	$1-100/l$	$1-100/l$	$0-10^3/l$	$0.1-5/l$
	Typical outflow	$0.1-50/l$	$0.1-50/l$	$0.1-50/l$	$0.5-50/l$	$0/l$	$0-500/l$	$0/l$
	Percent removal	50-90%	50-95%	50-95%	50%?	100%	50-90%	100%
	Final sludge	Contaminated	Contaminated	Contaminated	Contaminated	—	Contaminated	—

Land application or slow sand filtration as tertiary treatment	Chlorination as tertiary treatment	Effluent discharged to fresh water	Effluent discharged to sea	Unheated anaerobic digestion	Thermophilic digestion or composting	Agricultural application	Composting Toilets (three months minimum retention)
10-10 ⁴ /1 0-10 ² /1 99-100%	May survive	May survive for several weeks	May survive for several weeks	May survive for over three months	Killed rapidly at 60°C	May survive up to five months on soil	Probably eliminated
10-10 ³ /1 0/1 100%	Eliminated	May survive for several weeks	May survive for a few weeks	May survive for several weeks	Killed in twenty hours at 60°C	On soil, <i>S. typhi</i> may survive up to three months and other species for up to 1 year	A few non-typhoid species may survive
10-10 ³ /1 0/1 100%	Eliminated	May survive for several weeks	Unlikely to survive for more than forty days	Unlikely to survive for more than a few days	Killed in one hour at 55°C or in ten days at 40°C	May survive for up to three months	Probably eliminated
10 ⁴ -10 ⁷ /1 0-10 ³ /1 99.99-100%	A few may survive (regrowth likely)	May survive for several weeks	May survive for a few weeks	May survive for several weeks	Rapidly killed above 60°C	May survive for several months	Probably eliminated
0.1-10 ² /1 0/1 100%	Eliminated	May survive for several weeks	Unlikely to survive for more than eleven days	May survive for one or two weeks	Killed rapidly above 55°C	Unlikely to survive more than one week	Probably eliminated
Very few 0/1 100%	Eliminated	May survive for several weeks	Survive for not more than twenty hours	Survive for not more than two days	Killed in ten minutes at 50°C	Survive for up to fifteen days on soil	Eliminated
10-10 ³ /1 0/1 100%	Probably eliminated	May survive for three weeks	May survive for three weeks	May survive for three weeks	Killed in five minutes at 50°C and in one day at 40°C	May survive for one week if kept damp	Eliminated
10-10 ² /1 0/1 100%	Will survive	May survive for several weeks	?	Ova will survive	Killed in five minutes at 50°C and in one hour at 45°C	May survive on soil for twenty weeks under ideal conditions	May survive
0-10 ² /1 0/1 100%	Will survive	May survive for many months	May survive for many months	Ova will survive for many months	Kill in two hours at 55°C, in twenty hours at 50°C and 200 hours at 45°C	May survive on soil for several years	Survive well
1-10/1 0/1 100%	Probably eliminated	Ova will hatch and miracidia must find snail	Ova or miracidia will die	Ova may survive up to one month	Killed in one hour at 50°C	May survive up to one month if kept damp	Eliminated
0.1-50/1 0/1 100%	Will survive	Will survive for several weeks	Will survive for several weeks	Ova will survive for a few months	Killed in ten minutes at 59°C and in over four hours at 45°C	May survive on soil for over a year with sufficient moisture	May survive

CHAPTER 10

HEALTH ASPECTS OF SEWAGE SYSTEMS

10.1 INTRODUCTION

In this chapter we consider the "wet" systems that collect and treat excreta diluted by water. We include not only conventional sewerage and sewage treatment systems but also on-site methods of sewage disposal such as septic tanks and aquaprivies. The reader wishing more technical information should refer to Rybczynski, Polprasert, and McGarry (1978), Mara (1976), Metcalf and Eddy, Inc., (1972), Okun and Ponghis (1975), and Tebbutt (1977).

10.2 AQUAPRIVIES AND SEPTIC TANKS

Technical description

Aquaprivies and septic tanks are similar systems and are thus treated together. They comprise a sealed settling chamber in which solids accumulate and an effluent flows out. Septic tanks typically are located in the gardens of individual houses with water connections and full plumbing; they take all wastewater from a house, they have liquid retention times in the order of one to three days, and the effluent normally goes to a soakaway. Aquaprivies are located directly under the toilet, they usually receive only excreta and small volumes of flushing water; the liquid retention time may be as high as sixty days and effluents flow to soakaways or into small-bore sewerage systems. In some designs aquaprivies also receive sullage water, in which case retention times may decrease to a few days, depending on the volume of sullage produced. Designs for septic tanks and aquaprivies are shown in Figures 15 and 16.

Pathogen survival

Two main processes affecting pathogen removal are operative in septic tanks and aquaprivies. First, solids settle to the sludge layer at the bottom, and with them will settle any bacteria or viruses that are absorbed onto them, plus any ova or cysts that are sufficiently dense to settle. Thus the tanks operate as settling tanks and their efficiency at settling out pathogens depends on their retention times and their designs, particularly with regard to baffles or compartments designed to prevent hydraulic short-circuiting and to create quiescent conditions. Those pathogens that do not settle will remain in the liquid layers and eventually pass out in the effluent. The degree to which their concentration decreases depends on retention times and on their reaction to the rich anaerobic liquor in which they are held.

Generalizations about pathogen removal in aquaprivies and septic tanks are very difficult to make because designs and retention times vary enormously. Also, as the sludge layer of a septic tank builds up, retention times decrease, and the pathogen content of the effluent increases. It is very common to see aquaprivies and septic tanks that are long overdue for desludging and, in these cases, any good design features and good

Figure 15 — Two-compartment Septic Tank
(millimeters)

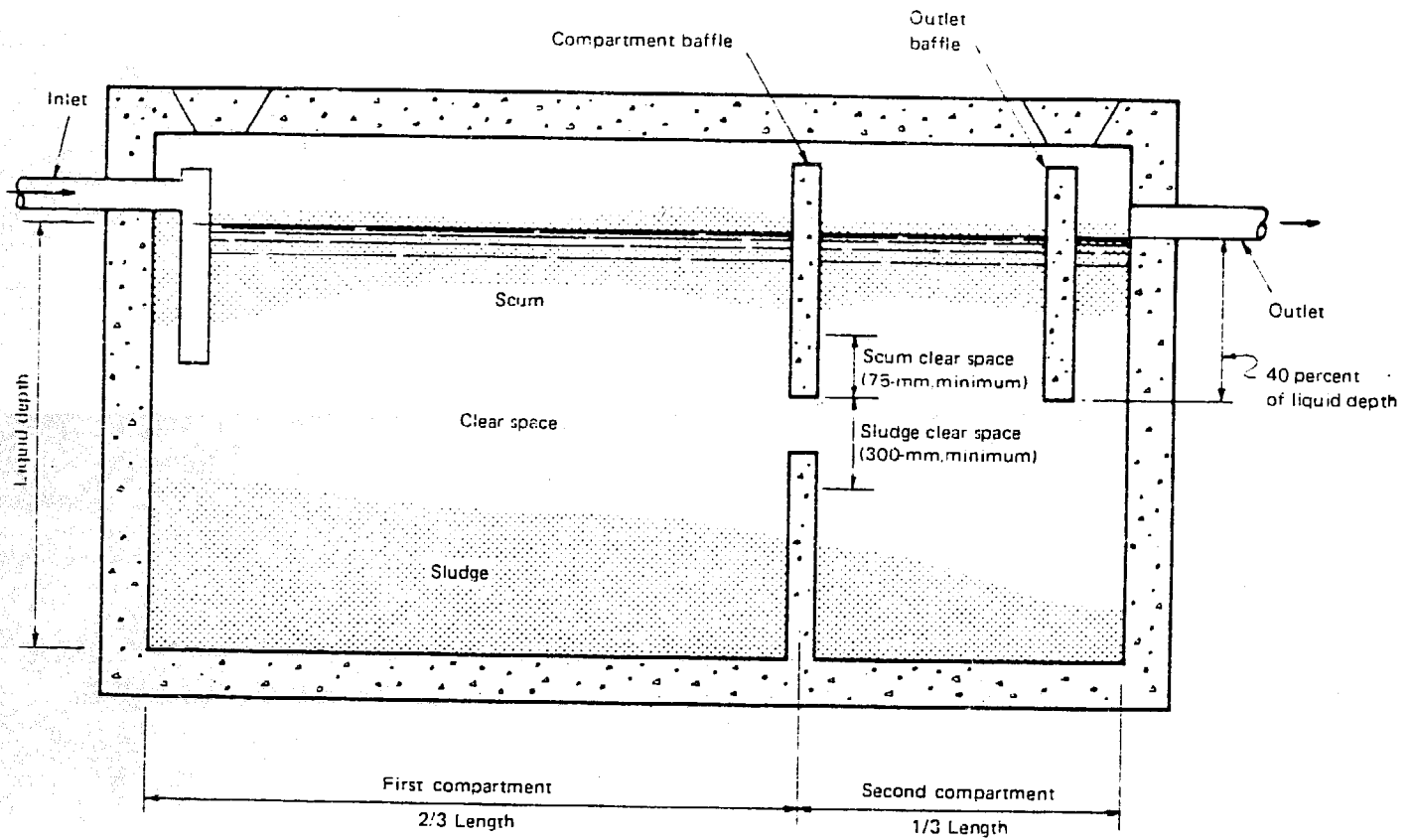

Source: Adapted from Cotteral and Norris (1969).

Figure 16— Self-topping Aquaprivy
(millimeters)

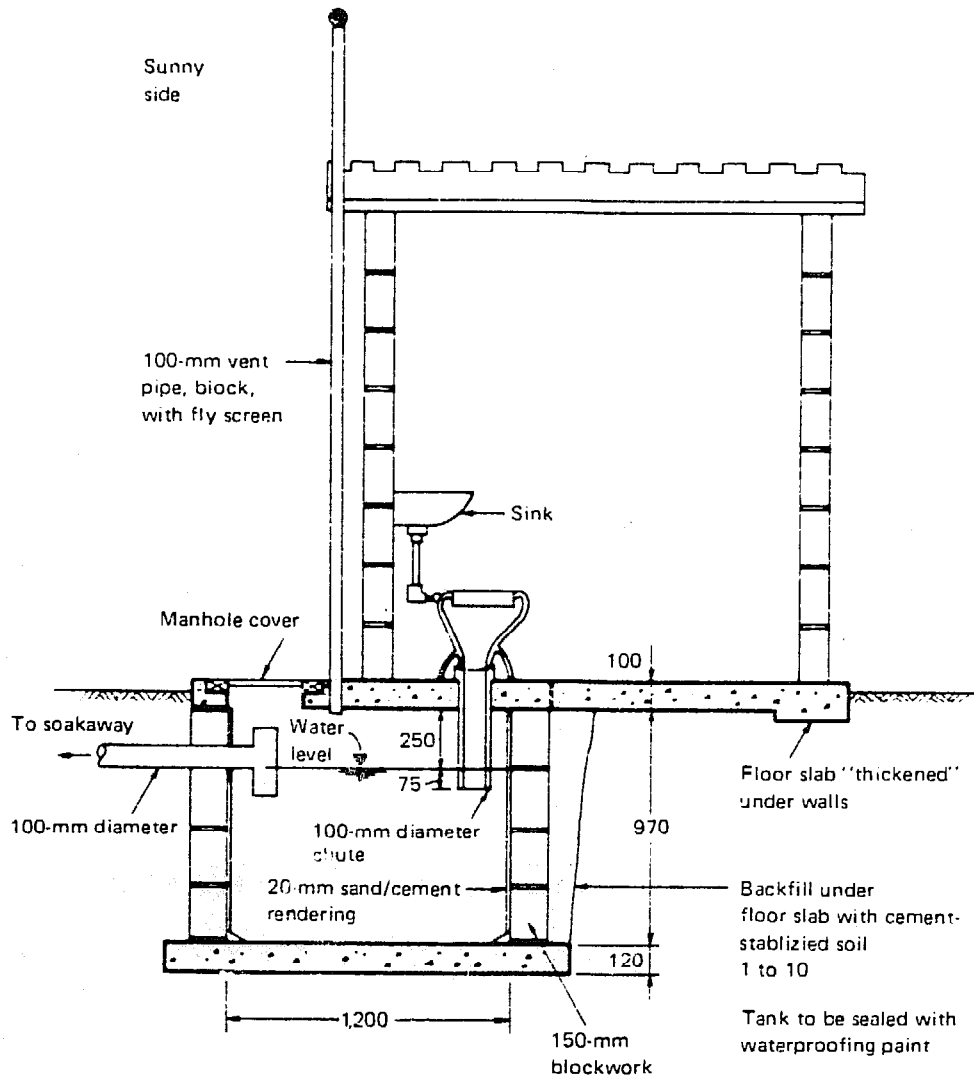

Note: It will usually be preferable to have a large sink on the outside wall rather than a small one inside. The sink need not be connected to a water supply, but if not, water must be available nearby to encourage the use of the sink for washing clothes. The seat may be replaced by a squatting slab.

Source: Feachem and Cairncross (1978).

pathogen removal abilities which may have been evident initially will have been largely negated by a failure to desludge at the correct regular intervals.

Since aquaprivy effluent quality depends greatly on retention time, the system is very sensitive to variations in hydraulic loading. If the loading rate is too low, and the water level is allowed to fall below the drop-pipe, the result will be strong odor release and probably mosquito breeding on a large scale. Attempts to guarantee an adequate water level by running sullage into the tanks will shorten retention times and raise the pathogen content of effluent.

There are few, maybe no, data available on effluent quality from aquaprivy installations. Septic tank literature, some of which is tabulated and abstracted in appendix VIII, will therefore be summarized. In a septic tank having a normal retention time (one to three days) the effluent produced will be rich in all pathogens contained in the influent. This position is illustrated in Figure 17. Removals of various types of pathogen from the effluent are as follows:

<u>Pathogen</u>	<u>Log₁₀ unit removals</u>
Viruses	0-2
Bacteria	0-2
Protozoa	0-2
Helminths	0-2

Poorly maintained and inadequately deslugged tanks will have especially poor pathogen removal characteristics.

A proportion of all pathogens will settle, and therefore fresh sludge will contain significant numbers of pathogenic bacteria, viruses, cysts, and ova (Figure 17). Whenever a septic tank is deslugged, it is inevitable that some sludge will be fresh and therefore hazardous. Sludge should therefore be handled with great care and disposed of by burial, composting, or digestion (either aerobic or anaerobic) in the same way as any sewage sludge and with the same effect on pathogens (see sections 9.4, 9.5, and 10.3). A well-designed aquaprivy, with a longer retention time (twenty days), may produce an effluent with only very low concentrations of enteric bacteria, protozoa, or helminth ova and many of the viruses may settle when absorbed onto solids. It is probable that a baffled aquaprivy with long retention (twenty days) would produce an effluent of substantially better quality than a normal septic tank or, indeed, than a conventional sewage treatment works. It must be assumed at present, however, that aquaprivy and septic tank effluents are highly pathogenic. If they flow to sewers they require treatment (probably in ponds) prior to any reuse. If they flow to soakaways, a groundwater pollution hazard may exist (see section 12.3). The position is summarized visually in Figure 17.

Figure 17— Pathogen Flow through Septic Tank

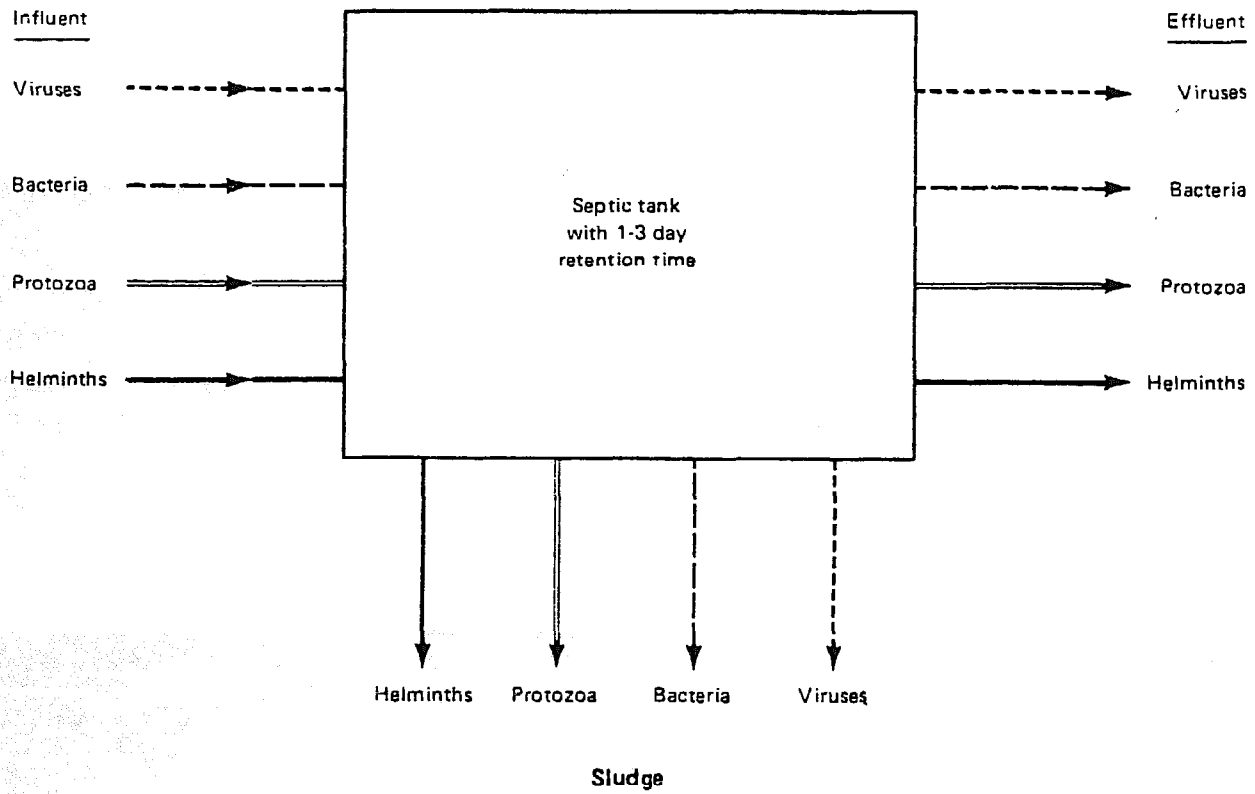

10.3 CONVENTIONAL SEWAGE TREATMENT

Technical description

A variety of unit processes are combined to form conventional sewage treatment. However, a very commonly used combination consists of:

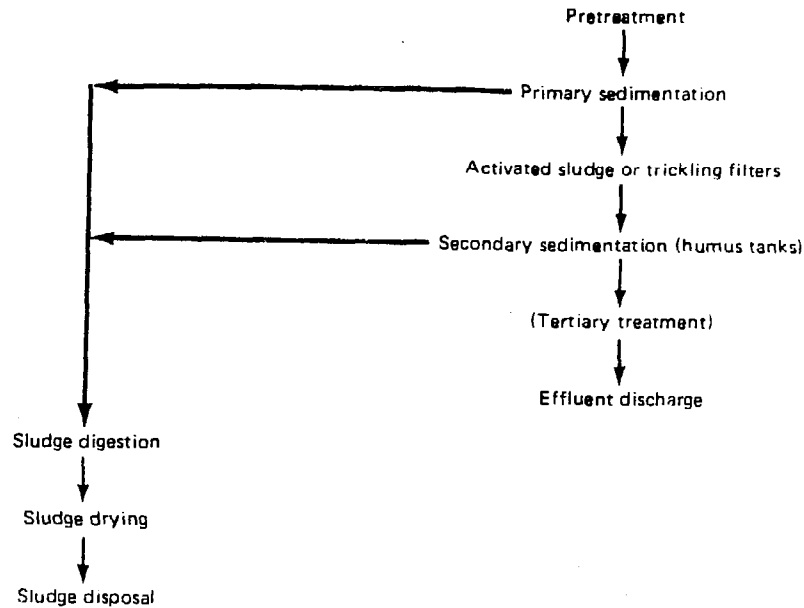

We will first discuss these various unit processes in turn and then the effect of complete treatment works will be discussed.

Pretreatment

Pretreatment by screening or comminution will have no effect on the pathogen content of sewage.

Primary sedimentation

An almost universal first stage in conventional treatment is the settling of suspended particles in primary sedimentation tanks. A retention time in the tank of two to six hours is normal. A proportion of pathogens in the sewage will settle to the sludge layer either by direct sedimentation or by being adsorbed onto suspended solids that are settling.

Many studies have found little or no virus removal by primary sedimentation, and, in actual treatment works, 20-30 percent removal seems to be a maximum. There is evidence that removal of viruses is not by sedimentation alone since, in contrast to the gradual reduction in suspended solids, there is a sharp decrease in virus content after three to six hours. Bacterial removal by primary sedimentation may be around 50-90 percent in three to six hours.

Shuval (1978) has collected data on the size and shape of ova and cysts and uses these to compute theoretical settling velocities, as follows:

<u>Organism</u>	<u>Size</u> (micrometers)	<u>Density</u> (grams/cubic centimeter)	<u>Assumed</u> <u>Shape</u>	<u>Settling Velocity</u> (meters/hour)
<u>Ascaris lumbricoides</u>	55 x 40	1.110	Sphere	0.650
Hookworm	60 x 40	1.055	Sphere	0.390
<u>Trichuris trichiura</u>	50 x 22	1.150	Cylinder	1.530
<u>Schistosoma</u> spp.	150 x 50	1.180	Cylinder <u>1/</u>	12.550
<u>Taenia saginata</u>	30	1.100	Sphere	0.260
<u>Entamoeba histolytica</u> (a)	5	1.100	Sphere	0.007
(b)	20	1.100	Sphere	0.110

1/ Schistosoma japonicum ova are spherical.

Actual settling velocities will be lower than these since in sedimentation tanks many factors hamper ideal settlement. The calculations indicate that only schistosomes, and maybe Trichuris, would have a reasonable degree of removal.

Studies on laboratory or full-scale primary sedimentation tanks are tabulated in appendix IX. Laboratory models always give higher removal efficiencies than actual plants, due to more idealized and carefully controlled conditions. Entamoeba histolytica cysts are reduced by 50 percent or less. Between 35 percent and 98 percent of helminth ova settle, with 50-70 percent being typical figures. Removal of various types of pathogens from the effluent are therefore as follows:

<u>Pathogen</u>	<u>Log₁₀ unit reduction</u>
Viruses	0-1
Bacteria	0-1
Protozoa	0-1
Helminths	0-2

Similar performance may often be expected from secondary settling tanks, except that these are often designed with higher overflow rates.

Flocculation of sewage (with ferric chloride, lime, or alum) will greatly improve the settlement of cysts and ova and maybe of other pathogens as well.

Trickling filters

Trickling filters alone do not appear to be very efficient at removing viruses from sewage. Reductions reported in the literature vary from 15-75 percent, with most results indicating 30-40 percent removal.

Indicator bacteria reductions in trickling filter effluent vary between 25-99.9 percent. Typical reductions appear to be 80-95 percent. Salmonella reductions in the range 71-99 percent are reported when humus tank removal is included. The lower the loading rate on the filter, the higher the bacterial removal.

Many protozoan cysts and helminth ova will pass through trickling filters. Entamoeba histolytica removals of 83-99 percent have been reported. Ova removal appears to be in the range of 20-90 percent, with higher reductions when the effect of the humus tank is included.

Removals, by trickling filters, of the various types of pathogens are therefore as follows:

<u>Pathogen</u>	<u>Log₁₀ unit reduction</u>
Viruses	0-1
Bacteria	0-2
Protozoa	0-2
Helminths	0-1

Several trickling filter studies have examined effluent after it has passed through a secondary sedimentation or humus tank. This tank may be expected to act like a primary sedimentation tank. Helminth ova reductions in combinations of trickling filters and humus tanks have been reported as 94-100 percent. Literature on pathogen removal by trickling filters is tabulated in appendix X.

Activated sludge

Both laboratory data and field experience indicate that activated sludge systems are more effective in removing viruses than trickling filters. Virus removals in activated sludge treatment works have been reported as up to 90 percent, although better results (up to 99 percent) are achieved in laboratory or pilot scale models. In poorly maintained activated sludge plants, the finding of very low virus removal rates is not unusual. Excreted bacteria reductions are similar or a little better. Indicator bacteria removals are reported as up to 99 percent, but increases may occur. Pathogenic bacteria removals are reported commonly between 60 percent and 99 percent at normal aeration time (six to twelve hours), but may be as high as 99.9 percent following extended aeration for twenty-four hours or more.

The activated sludge process has little effect on cysts and ova but substantial proportions of ova will be removed in the secondary settling tanks. Complete activated sludge treatment plants have been reported to remove 80-100% of ova.

Considering the activated sludge process in isolation, removal efficiencies may be summarized as follows:

<u>Pathogen</u>	<u>Log₁₀ unit reduction</u>
Viruses	0-1
Bacteria	0-2
Protozoa	0-1
Helminths	0-1

Literature on activated sludge plant performance in the removal of excreted organisms is tabulated in appendix XI.

Sludge digestion

It is clear from the above discussion that sludge from primary and secondary sedimentation tanks will contain a heavy load of viruses, bacteria, protozoa, and helminth ova. The fate of these pathogens depends on which of the many systems of sludge treatment is adopted. Anaerobic sludge digestion usually approximates to one of three systems: thirteen days at 50°C, twenty-eight days at 32°C, or 120 days unheated.

The first stage is often followed by a second stage settling, or thickening, process in which the sludge stands for a similar time to the first stage to allow the supernatant liquor to be drawn off.

If the digestion process is a batch process, thus guaranteeing that all the sludge has been at temperature x for time y, we would anticipate the following pathogen removal performance:

<u>Time</u>	<u>Performance</u>
13 days at 50°C	All pathogens removed.
28 days at 32°C	Viruses and protozoa removed; some bacteria and many helminth ova remain.
120 days unheated	Protozoa removed; persistent helminth ova (especially <u>Ascaris</u> and <u>Taenia</u>) remain with a few pathogenic bacteria and viruses.

If, however, the digesters are worked as a continuous process, with sludge being added and removed daily or more frequently, it is not possible to guarantee retention times, and pathogen survival will be appreciably higher than indicated above.

The anticipated removal characteristics, and the effect of subsequent sludge thickening, are summarized in Figures 18 and 19. Some literature is tabulated in appendix XII. In summary, we see that protozoa will survive none of the digestion and thickening processes considered. Therefore, protozoan cysts are a feature of the effluents from conventional treatment plants and will not be found in the sludges. With continuous operation, thermophilic digestion will leave small numbers of ova and bacteria, while 120 days unheated digestion will leave only ova. The only digestion process producing a guaranteed pathogen-free sludge is batch thermophilic digestion. Ova will always, and pathogenic bacteria will sometimes, be found in the sludges from all other digestion processes considered.

Sludge may be composted, rather than digested, and this technology is discussed in section 9.5 and reviewed by Shuval (1977a).

Figure 18- Pathogen Flow through Various Continuous Sludge-treatment Processes

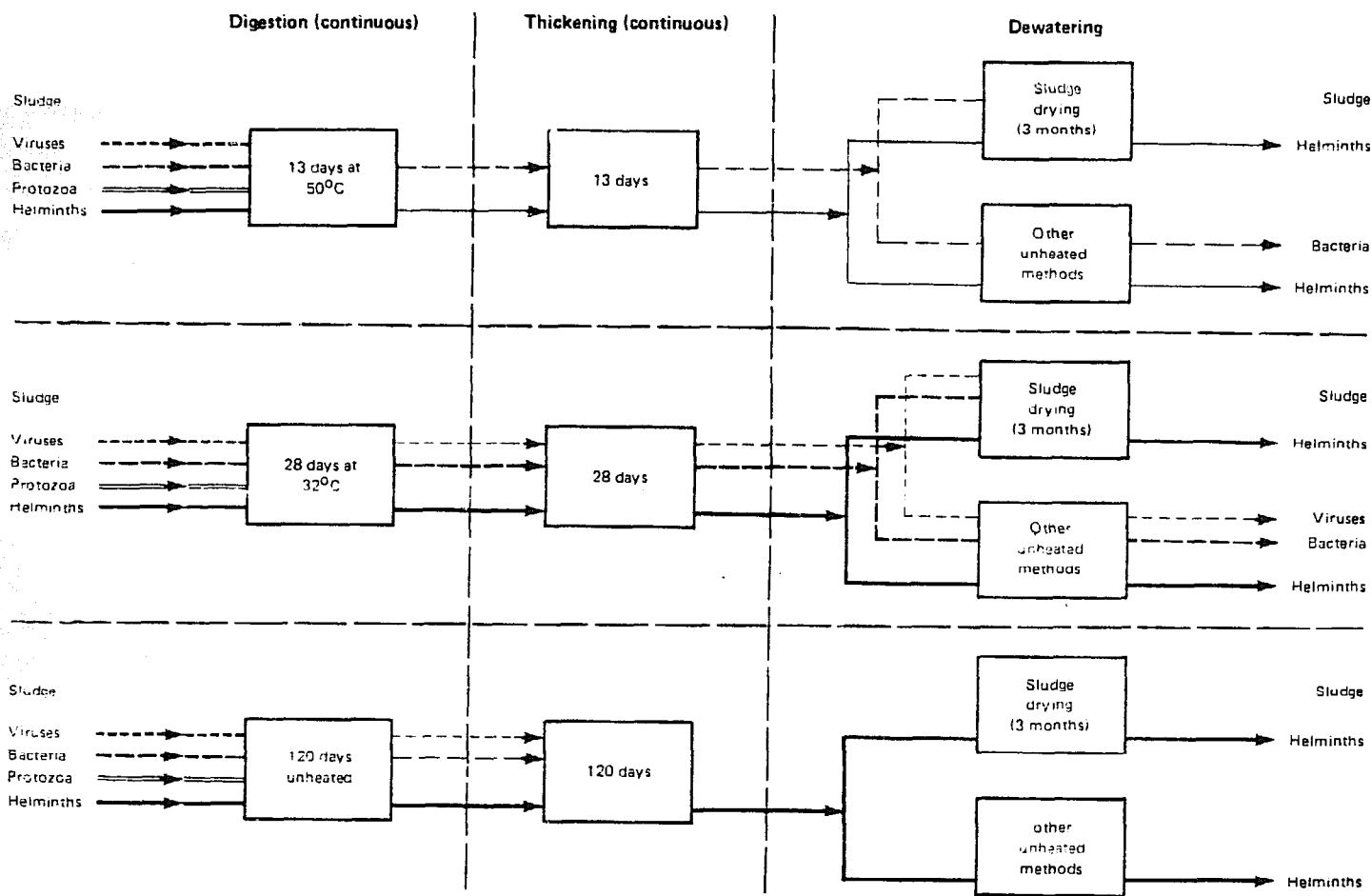

Note: Faint lines indicate low concentrations of pathogens.

Figure 19 - Pathogen Flow through Various Batch Sludge-treatment Processes

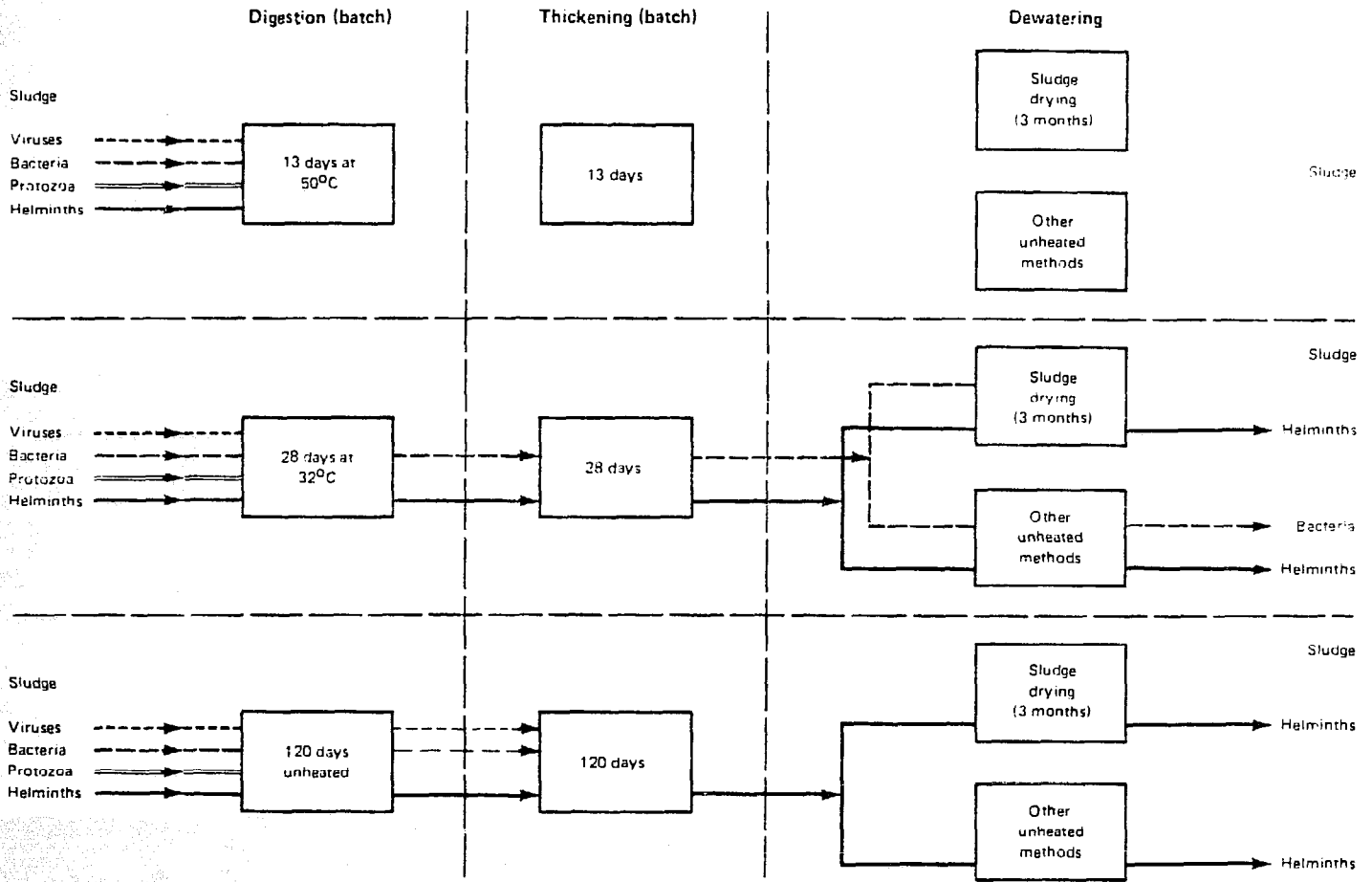

Note: Faint lines indicate low concentrations of pathogens.

Sludge dewatering

Figures 18 and 19 also summarize the impact of sludge dewatering on digested sludges. Sludge drying in open beds for two to three months will remove the great majority, possibly 100 percent, of enteric viruses and bacteria at warm temperatures ($>20^{\circ}\text{C}$). Protozoan cysts will be destroyed. Only the persistent ova will survive in numbers, especially those of Ascaris, Trichuris, and Taenia. Some literature on sludge drying is tabulated in appendix XIII.

Other dewatering processes, such as vacuum-filtration, pressure filtration, and centrifugation, will have little effect upon pathogen content. Wet oxidation processes (such as the Zimmerman process), however, which are sometimes used to condition sludges prior to dewatering, will completely sterilize the sludge since they involve heating under pressure to 250°C for about one hour. Sterilization will also result from flash-drying processes (such as the Carver-Greenfield process), in which sludge is spray-dried by high temperature combustion gases at $300-500^{\circ}\text{C}$.

Complete treatment works

Having discussed the effect on pathogens of the unit processes that make up conventional sewage treatment, we can now discuss the effect of combinations of these processes.

First, we consider a treatment plant featuring trickling filters and primary and secondary sedimentation. The effluent from such a plant will contain significant concentrations of viruses, bacteria, protozoa, and helminth ova and is unsuitable for direct reuse in agriculture (Figure 20). It may often be unsuitable for discharge to fresh water bodies where those water bodies are used without treatment for domestic water suppliers by downstream populations. The minimum effluent retention time in the total plant may be around five hours, and this largely explains why the effluent, even if it is of adequate chemical quality (for instance, the effluent might conform to the established physicochemical standard of less than 30 milligrams per liter of suspended solids and less than 20 milligrams/liter of BOD_5), will be of poor microbiological quality. Effluent quality may be improved by using double filtration or recirculation, but the final effluent will still be highly pathogenic. The only way to produce a reasonably good quality effluent from a health viewpoint is by certain tertiary treatment processes (section 10.6). Even effluent chlorination may not be effective (section 10.7).

Effluents from activated sludge plants will be of marginally better quality than those from trickling filters but will still be heavily contaminated, irrespective of their chemical quality (Figure 21). The minimum liquid retention time in the plant may be only twelve hours, and the final effluent will contain significant numbers of any pathogen found in the raw sewage. Tertiary treatment is indicated prior to reuse or prior to discharge into a river that downstream populations are using.

Figure 20 - Pathogen Flow through Conventional Sewage Treatment Plant Featuring Trickling Filters

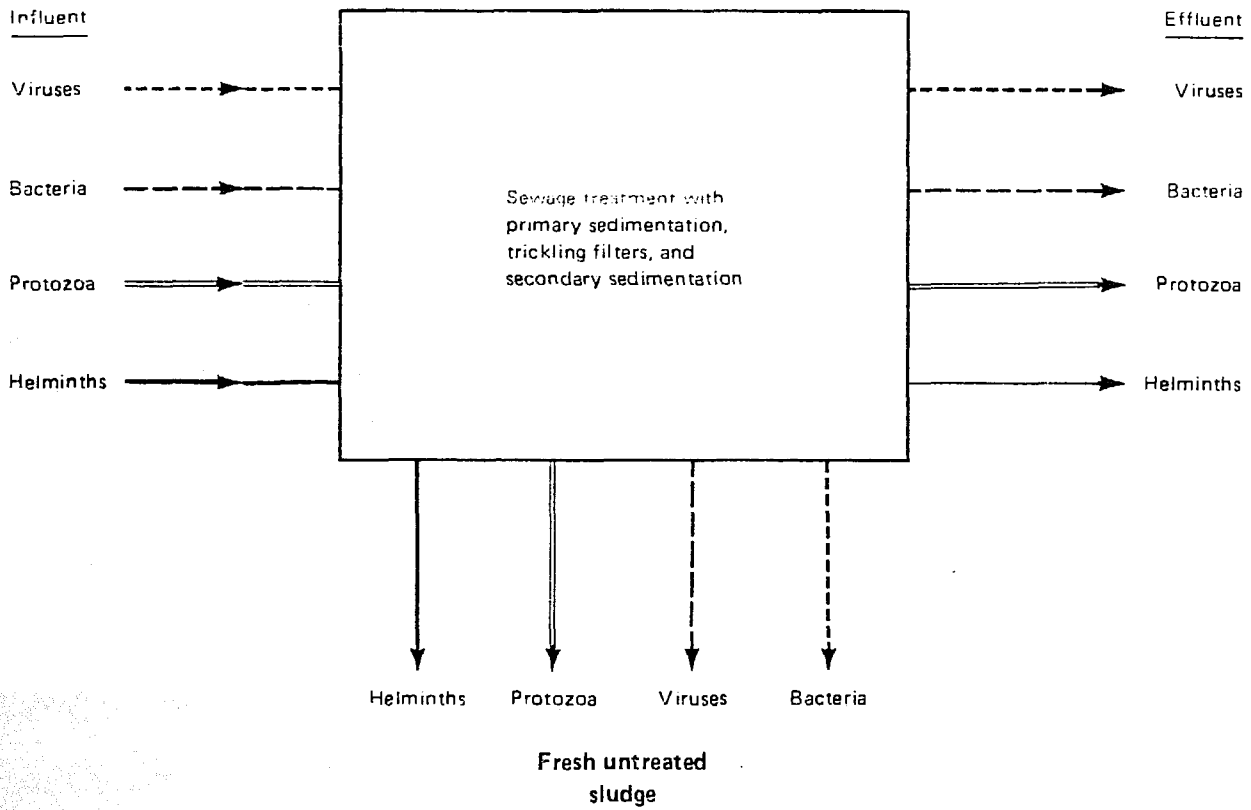

Note: Faint line indicates low concentrations of pathogens.

Figure 21 - Pathogen Flow through Conventional Sewage Treatment Plant Featuring Activated Sludge

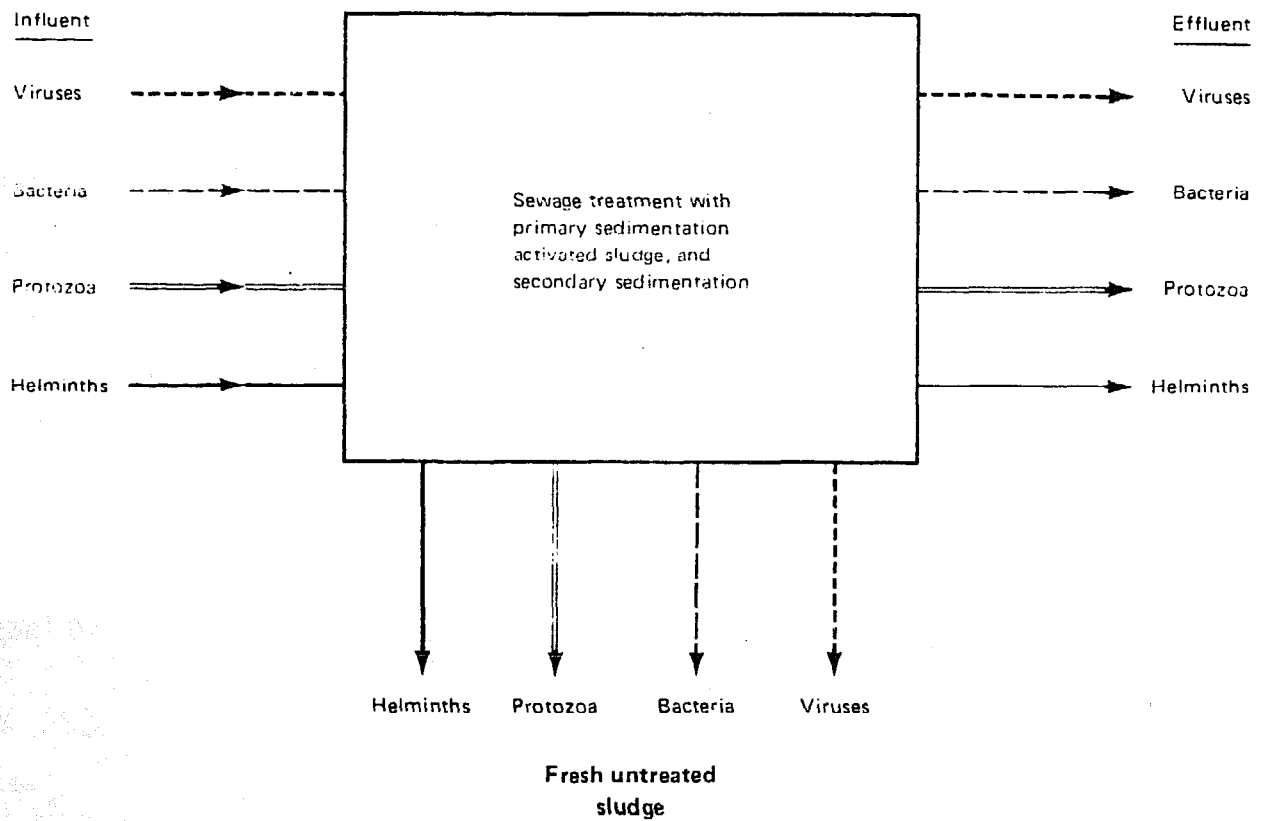

Note: Faint line indicates low concentrations of pathogens.

The quality of the sludge depends on what treatment it receives. Fresh sludges from primary and secondary sedimentation tanks will contain pathogens of all kinds. Digestion at 50°C for thirteen days will kill all pathogens, provided that a batch process is used. Digestion at 32°C for twenty-eight days will remove protozoa and enteroviruses, provided that a batch process can be used. Digestion for 120 days unheated will remove all pathogens except helminths, provided that a batch process is used. Continuous addition and removal of sludge will allow pathogens to pass through all processes.

Sludge drying for at least three months will be very effective against all pathogens except helminth ova. Other unheated dewatering techniques will have little effect on the pathogenic properties of sludge.

This somewhat complex situation is summarized visually in Figures 18 and 19. They show that only a batch digester at 50°C will guarantee a pathogen-free sludge. Continuous digestion (as in practice) at 50°C may produce a sludge with some helminth ova, or with enteric bacteria and ova if sludge drying beds are not used. All other alternatives will produce a sludge with helminth ova, and some (such as mesophilic digestion followed by vacuum filtration) will produce a sludge with enteric viruses and bacteria as well.

The importance of temperature and time is clearly illustrated by Figures 18 and 19. From a health point of view, the object of a sewage treatment works should be to retain all solids and liquids for the maximum time and/or to heat them to the maximum temperature feasible. Batch processes are far more reliable in achieving this than continuous processes, and we suggest that thought be given to the design and economics of batch digesters in circumstances where sludge is to be reused in agriculture.

A compilation of original source findings on conventional treatment works will be found in appendices IX, X, XI, XII, and XIII.

10.4 AERATED LAGOONS

Technical description

Aerated lagoons resemble small waste stabilization ponds with floating mechanical aerators, but they are more correctly considered as a simple modification of the activated sludge process. Screened sewage, rather than settled sewage, is aerated and there is no sludge return (Figure 22). Retention times for domestic sewage are typically two to six days and depths are 2-4 meters. The effluent from the lagoon contains 200-500 milligrams per liter of suspended solids (activated sludge flocs) and therefore requires further treatment either in an ordinary secondary sedimentation tank (retention time: two hours minimum) or in a settling pond (retention time: five to ten days). The latter is more advantageous as it is often cheaper, easier to maintain, and more efficient for excreted pathogen removal.

Aerated lagoons are often useful in extending the capacity of an existing waste stabilization pond system (Figure 24).

Pathogen survival

In the aerated lagoon itself there will be incomplete removal of excreted pathogens, although as a result of the longer retention times the removal achieved is better than that obtained in the conventional activated sludge process. In the settling pond there will be complete removal of excreted protozoa and helminth ova, although schistosome and hookworm larvae may appear in the effluent, which also contains bacterial pathogens and viruses. The effluent can, however, be treated in one or more maturation ponds to achieve any desired level of pathogen survival.

10.5 OXIDATION DITCHES

Technical description

Oxidation ditches are another modification of the activated sludge process: screened sewage is aerated in and circulated around a continuous oval ditch by one or more special aerators, called "rotors," placed across the ditch (Figure 23). The ditch effluent is settled in a conventional secondary sedimentation tank and almost all the sludge (95 percent) is returned to the ditch; the small quantity of excess sludge is placed directly on sludge drying beds. The hydraulic retention times are one to three days in the ditch and two hours minimum in the sedimentation tank. Because a very high proportion of sludge is recycled, the mean solids retention time is twenty to thirty days; as a result there is only a small production of excess sludge, which is highly mineralized and requires only dewatering on drying beds.

The main engineering advantages of the process are that primary sedimentation is eliminated and that sludge production and treatment is minimal.

Pathogen survival

The effluent from the sedimentation tank has a pathogen content similar to that produced by the conventional activated sludge process, although as a result of the increased retention time, slightly lower survivals are achieved. The small quantity of sludge produced is similar in quality to that produced by an aerobic digester and contains the same range of excreted pathogens.

10.6 TERTIARY TREATMENT

Tertiary treatment methods are increasingly used in Europe and North America to improve the quality of effluent produced by conventional treatment works. We are not referring here to the sophisticated systems designed to reclaim effluent for potable water supply, such as that used at Windhoek in Namibia (Stander and Clayton, 1977), but rather to tertiary treatment processes used to upgrade the physicochemical quality of an effluent prior to discharge. These processes were not primarily designed for pathogen removal, but some of them do have good pathogen removal characteristics.

Figure 22 – Flow Diagram for Aerated Lagoon Incorporated Sludge Digestion

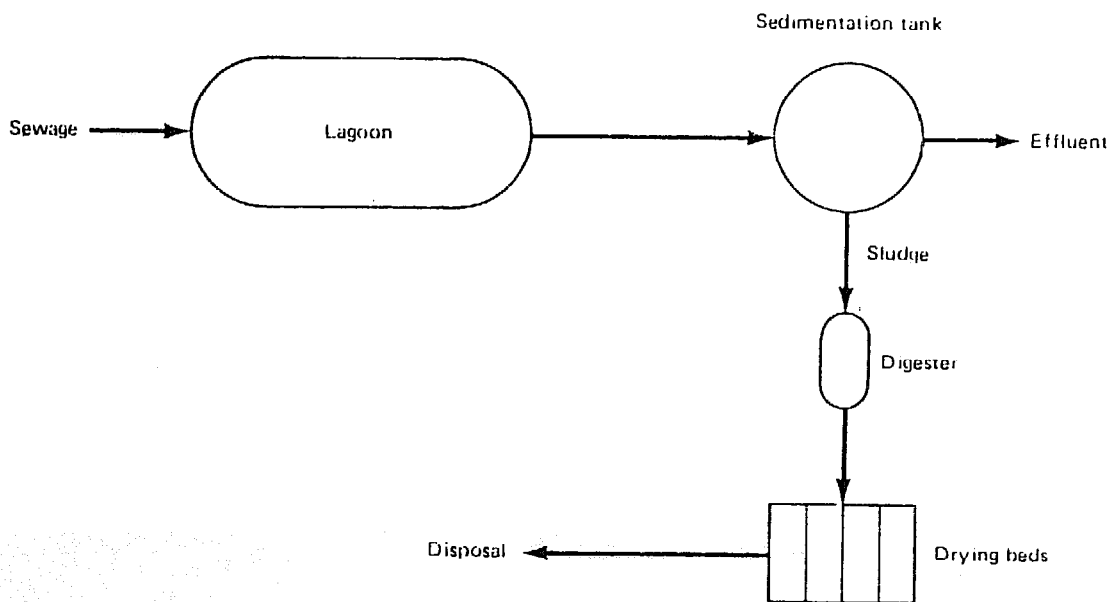

Source: Mara (1976). Used by permission of John Wiley and Sons Ltd.

Figure 23 - Flow Diagram for Oxidation Ditch.

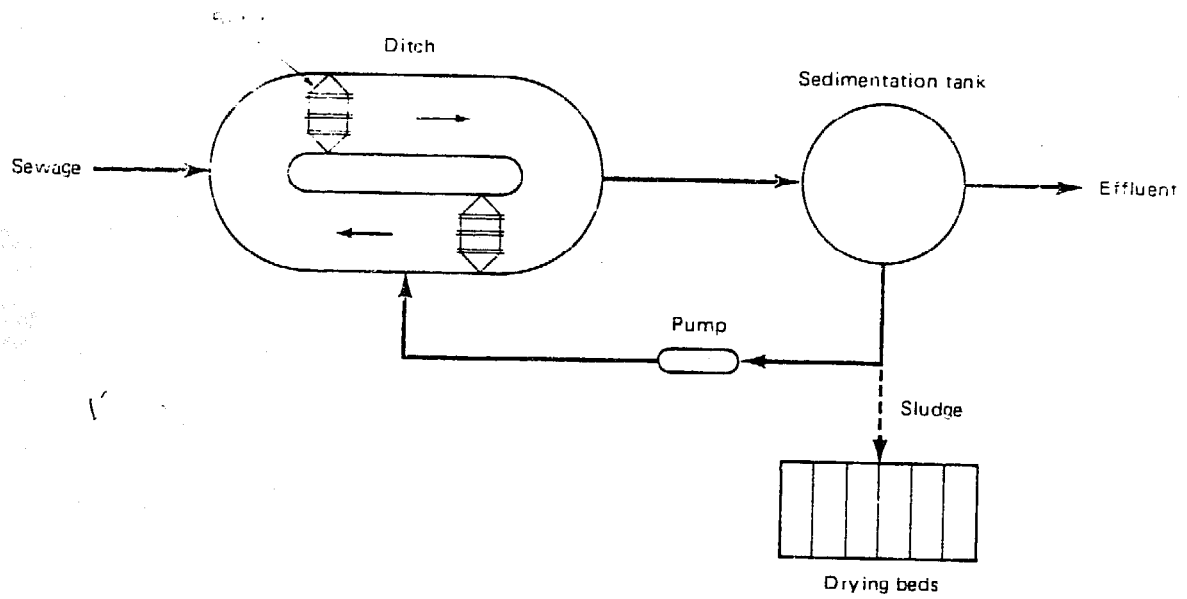

Source: Mara (1976). Used by permission of John Wiley and Sons Ltd.

Figure 24 — Stages in Development of a Waste Stabilization Pond-aerated Lagoon System

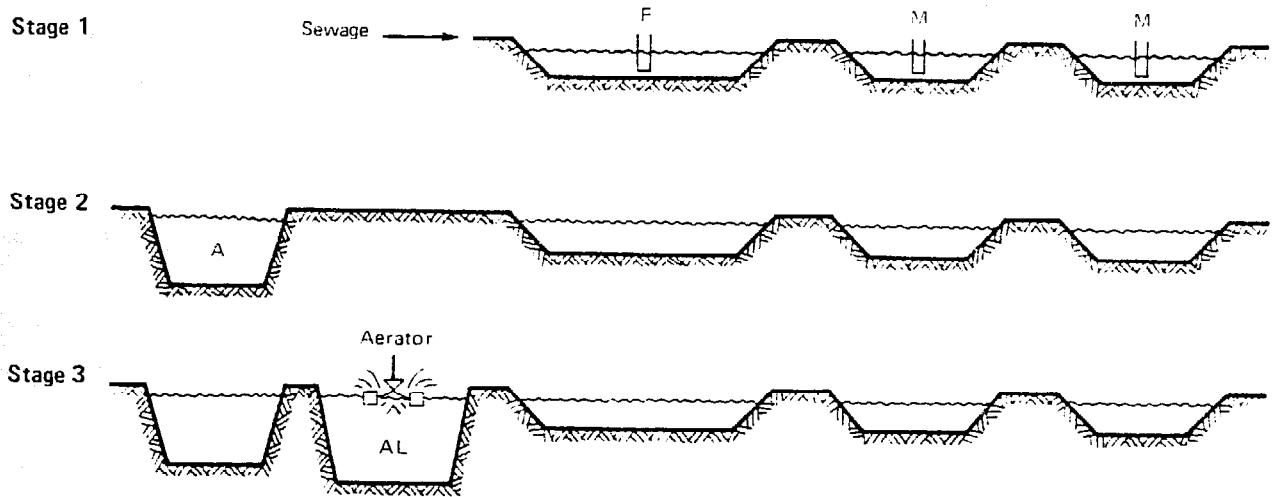

F, facultative pond; M, maturation pond; A, anaerobic pond;
AL, aerated lagoon.

Note. At stage 3 additional maturation ponds will probably be necessary.
In some cases septic tanks may replace anaerobic lagoons (usually for
populations below 10,000).

Rapid sand filtration

This is perhaps the most common tertiary treatment method found in larger treatment works. High loading rates (200 cubic meters per square meter daily) and frequent backwashing (one to two days) prevent the buildup of much biological activity in the filter. Some viruses will be adsorbed and some bacteria retained. Cysts and ova may be retained due to their size. In short, effluent pathogen content may be improved, but not substantially, and probably not enough to justify the investment on health grounds.

Slow sand infiltration

These filters may be used on small treatment works. Their low loading rates (2-5 cubic meters per square meter daily) cause them to occupy a large land area. Substantial biological activity builds up, especially in the upper layer of the filter, and pathogen removal may be very high. Four log unit removals of viruses and bacteria may be expected from a well-run unit, with viral removal a little higher than bacterial removal. Complete cyst and ova retention have been recorded. Slow sand filters are therefore highly effective in removing pathogens from a conventional effluent, but their land requirement makes them suitable only for small treatment works.

Grass plots

Another appropriate tertiary treatment method for small communities is land application. Effluent is distributed over grassland, ideally at a slope of about 1 in 60, and collected in channels at the bottom of the plot. Loadings are in the range 0.05-0.3 cubic meters per square meter daily. There is little or no information about this process applied in the tropics or in developing countries. If well managed, it should provide a high level of pathogen removal similar to slow sand filters (see above). If poorly managed, it will probably lead to the creation of a foul and insanitary bog.

Lagoons

Conventional effluents can be upgraded in maturation lagoons. The principles involved are exactly as described for waste stabilization pond systems (section 10.8). If two or more maturation ponds are used, with perhaps five days retention in each, total removal of cysts and ova will result. Very high levels of viral and bacterial removal are also achieved (see section 10.8) and, by adding sufficient ponds, a pathogen-free effluent may be produced.

Other methods

Other methods of tertiary treatment, such as microstrainers or upward-flow clarifiers, are used but have not been evaluated for pathogen removal.

10.7 EFFLUENT CHLORINATION

The chlorination of sewage effluents is practised in only a few countries (notably North America and Israel). Its purpose is to reduce the pathogen content of conventional effluents. As we discuss elsewhere (section 8.2), it represents the borrowing from the water treatment industry of a technology that might overcome the very poor pathogen removal characteristics of conventional treatment systems. Effluent chlorination, however, has a number of serious limitations, one of which is that, in some senses, it does not work.

Effluent chlorination is complex and difficult to control. Chambers (1971) writes:

Chlorination of wastewater effluents is a vastly more complex and unpredictable operation than chlorination of water supplies. It is extremely difficult to maintain a high, uniform and predictable level of disinfecting efficiency in any but the most efficiently operated waste treatment plants.

It should thus be rejected except where the highest levels of management and process control are guaranteed.

Chlorine has to be applied in heavy doses (10-30 milligrams per liter) to achieve coliform effluent concentrations of less than 100/100 milliliters. These levels of chlorine will also kill pathogenic bacteria if the chlorine demand of the effluent is not too high, if the chlorine and the effluent are well mixed, and if adequate contact time (at least one hour) is allowed. Coliform and E. coli regrowth following chlorination have been widely reported, however, and the regrowth of bacterial pathogens has not been fully ruled out. Additionally, all other bacteria in the effluent are affected by the chlorine and many of these are essential for the natural self-purification of the effluent. If the effluent is discharged into a river or lake, the chlorine may thus adversely affect the ecology of the receiving water and hinder natural oxidation processes therein.

Turning to viruses, it has been found that they are much more resistant to chlorination than bacteria. Doses of 30 milligrams per liter and above have been recommended and, even at these doses, complete viral removal may not be achieved (Melnick, Gerba, and Wallis, 1978). It appears, from South African work for instance (Nupen, Bateman and McKenny, 1974), that chlorination beyond that breakpoint with resultant free residual chlorine, as HOCl, may be necessary to guarantee virus removal. Depending on the chlorine demand and pH of the effluent, breakpoint chlorination may require high doses and will always require very efficient and vigilant process control.

It is unlikely that chlorination of effluents will be effective in eliminating protozoan cysts, because these are more resistant than either bacteria or viruses. Most helminth ova will be totally unharmed by effluent chlorination.

Thus, we see that effluent chlorination may not be particularly effective at removing pathogens from conventional effluents. It may have deleterious consequences for the environment, which include the possible proliferation of carcinogenic chlorinated hydrocarbons.

10.8 WASTE STABILIZATION PONDS

Technical description

Waste stabilization ponds are large shallow ponds in which organic wastes are decomposed by microorganisms in a combination of natural processes involving both bacteria and algae. The waste fed into a stabilization pond system can be raw sewage, aquaprivv effluent, or diluted night soil (Figure 24).

Waste stabilization ponds are the most economical method of sewage treatment wherever land is available at relatively low cost. Thus they are widely used in North America. Their principal advantage in warm climates is that they achieve very low survival rates of excreted pathogens; they achieve this at a much lower cost than any other form of treatment and with maintenance requirements several orders of magnitude simpler. In fact a pond system can be designed to guarantee, with a very high degree of confidence, the total elimination of all excreted pathogens. This is not normally done because the incremental benefits resulting from achieving zero survival, rather than very low survival, are less than the associated incremental costs. Waste stabilization ponds are the best form of treatment in tropical developing countries because they can achieve any desired level of pathogen removal. Strictly from the health point of view, the fact that ponds do this at lowest cost is an additional advantage.

There are three types of ponds in common use:

- (i) Anaerobic pretreatment ponds, which function much like open septic tanks; they have retention times of one to five days and depths of 2-4 meters;
- (ii) facultative ponds in which the oxygen necessary for bio-oxidation of the organic material is supplied principally by photosynthetic algae, which grow naturally and with great profusion in them; they have retention times of ten to forty days and depths of 1-1.5 meters; and
- (iii) maturation ponds that receive facultative pond effluent and are responsible for the quality of the final effluent; they have retention times of five to ten days and depths of 1-1.5 meters.

Anaerobic and facultative ponds are essentially designed for BOD removal, whereas the function of maturation ponds is the destruction or removal of excreted pathogens. Thus these three types of ponds should

normally be used in conjunction with one another to form a series of ponds (Figure 24). Although it is all too common to see only a single facultative pond treating domestic wastes, this represents a false economy. Maturation ponds are necessary in order to ensure low pathogen survivals. Thus good designs incorporate a facultative pond and two or more maturation ponds; for strong wastes (BOD₅ >400 milligrams per liter) the use of anaerobic ponds as pretreatment units ahead of facultative ponds is often advantageous, because they minimize the land requirements of the whole pond system (Figure 24).

Pathogen survival

Several authors have reported on the fate of fecal indicator bacteria in ponds. The removal of Escherichia coli in anaerobic ponds has been reported as 70-85 percent at 20°C in three and one-half days and 46-65 percent at 9°C in three and one-half and seven days. In single facultative and aerobic ponds E. coli reductions of 80->99 percent have been reported after ten to thirty-seven days at various temperatures. Removals of fecal streptococci in single facultative or aerobic ponds are generally similar or better. Very high removals of 99.99 percent or better have been reported for series of three, four, or more ponds. Various reports indicate that one or two ponds will remove 90-99 percent of Salmonella or other enteropathogenic bacteria and that complete elimination can be achieved in pond systems with long retention times (thirty to forty days), particularly if ambient temperatures are >25°C. It is known both from theoretical considerations and field experience that a series of ponds have BOD and fecal bacterial removal performances much superior to that achieved in a single pond of the same overall retention time. A series of five to seven ponds, each with a retention time of five days, can produce an effluent containing <100 fecal coliforms and fecal streptococci per 100 milliliters; such an effluent can be safely used for unrestricted irrigation.

Very little is known at present about the fate of viruses in ponds in warm climates or developing countries. Virus removal in ponds may occur principally by settlement through adsorption onto the surfaces of settleable solids. There are probably other factors involved in virus removal that are not yet fully understood; for example, it is known that virus survival in shallow maturation ponds (1.5 meters deep) is better than in deeper ponds.

Reports on the effect of ponds on protozoan cysts and helminth ova indicate 100 percent removals in all cases where well-designed, multicelled ponds with an overall retention time of more than twenty days were investigated. Hookworm larvae may survive for up to sixteen days in aerobic ponds. For this reason, hookworm larvae have been reported in the effluent from ponds with an overall retention time of less than ten days; they have not, however, reported on the effluent of ponds with more than twenty days retention. Schistosome eggs in an anaerobic pond will very largely settle; in a facultative pond they will either settle or hatch into miracidia. Miracidia will either die or infect a suitable snail, if snails of the correct species are colonizing the pond, as may occur in badly maintained and vegetated ponds. Even if cercariae emerge they should not find a human host to invade and will die within forty-eight hours.

An important consideration with reference to waste stabilization ponds is that, again only under conditions of inadequate maintenance, they may become mosquito breeding sites. The most common mosquitoes to be found breeding in ponds belong to the Culex pipiens complex, which breed in polluted waters. The distance between the town producing the sewage and the pond system treating it is usually well within the flight range of the mosquitoes, which may be as great as 10 kilometers. Any large outbreak of mosquitoes will thus be a nuisance, depending on the weather conditions at the time. Moreover, since the mosquitoes can serve as vectors for diseases (for example Culex pipiens is a vector of bancroftian filariasis), the need to keep waste stabilization ponds free of mosquitoes is obvious. All studies carried out on ponds indicate the important role that vegetation around the pond banks and its contact with the water plays in encouraging mosquito breeding; for example, Myklebust and Harmston (1962) showed a close correlation between the number of mosquito larvae they found in ponds and the vegetation growth in and around them. It is easy in practice, however, to prevent vegetation growth in ponds by making them >1 meter deep and using concrete slabs, rip-rap, or soil-cement on the embankments at the surface water level. The function of the latter is to prevent not only vegetation from growing down the embankment but also the erosion of the embankment by wave action. Mosquito breeding in ponds can thus be largely eliminated at the design stage.

Summary

Well-designed pond systems, incorporating a minimum of three cells and having a minimum total retention time of twenty days, produce an effluent that will either be completely pathogen free or will contain small concentrations of enteric bacteria and viruses. Pathogenic helminths and protozoa will be completely eliminated. Any bacterial or viral pollution can be reduced or eliminated by adding more cells to the system. The effluent is suitable for direct reuse or discharge into receiving waters. The position is summarized in Figure 25.

A compilation of original sources and findings on waste stabilization ponds will be found in Appendix XIV.

10.9 SUMMARY

Some of the information in this chapter is summarized in a comparative form in Table 18.

Figure 25— Pathogen Flow through Waste-stabilization Ponds System

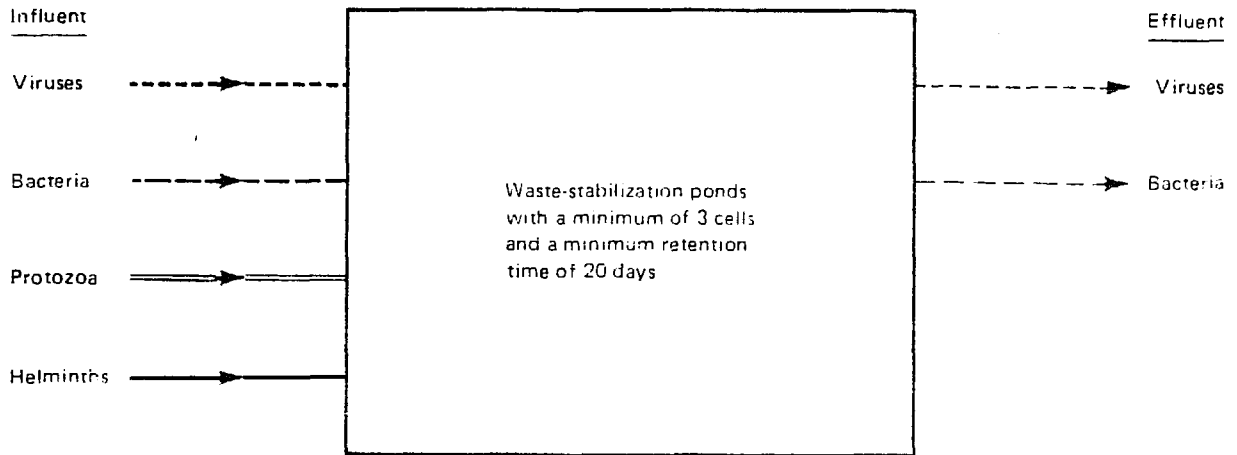

Note: Faint lines indicate low concentrations of pathogens.

CHAPTER 11

THE REUSE OF EXCRETA

11.1 INTRODUCTION

Human excreta, in whatever form, should be regarded as a natural resource to be conserved and reused rather than discarded. It may be reused as night soil, as sewage, or as the effluent or sludge from a sewage treatment works. It may also be composted together with organic material (such as urban refuse), which provides a necessary source of carbon for the composting process (see section 9.5).

In whatever form it is reused, excreta may provide a rich source of nitrogen and other nutrients necessary for the growth of terrestrial and aquatic plants. If reused as sewage or sewage effluent, it also provides valuable water, and reuse of this kind may be regarded as the recycling of water and human excreta together. When excreta are broken down anaerobically by microbial action, methane is produced and can be used as a source of energy for heating, lighting, and other purposes.

The purpose of this chapter is to set out the health implications of excreta reuse. For a literature review and technical assessment of reuse, the reader should refer to Rybczynski, Polprasert, and McGarry, (1978). The reuse processes considered are agricultural reuse, aquacultural reuse, and biogas generation.

11.2 AGRICULTURAL REUSE

The most common, and some ways the most attractive, form of waste reuse is in agriculture. This may be accomplished by the application of sewage, sludge, or night soil to the land. The method of application depends in part upon the solids content of the material, and each of the fecal materials mentioned above may be applied raw or following varying degrees of treatment. When applied to farming land, these materials are important soil conditioners and often provide additional plant nutrients. Sewage and sewage effluents will also provide water, which may be a very scarce resource in arid areas.

The health hazards associated with reuse are of two kinds: (i) the occupational hazard to those who are employed to work on the land being fertilized; and (ii) the risk that contaminated products of the reuse system may subsequently infect man or other animals that eat or handle them. The occupational hazard is dealt with separately, so it is only the risk from contaminated products that will be considered here. The risk from contaminated products depends very largely on the type of product. We will consider them here in three categories: (i) foodstuffs for human consumption; (ii) foodstuffs for animal consumption; and (iii) other products.

Foodstuffs for human consumption

The direct agricultural application of raw night-soil to food crops has been widely practiced in many countries for centuries. There is no doubt that this reuse technique contributes significantly to the transmission of a wide variety of human infections. It is therefore condemned by most, if not all, health authorities and advisory agencies. Hence, attention is now directed to the reuse of treated effluents, sludges, and night-soil to enhance agricultural production.

The health problems associated with reuse in human food production may be broken down into a series of questions as follows:

- (i) How many pathogens of which types reach the field or crop?
- (ii) Are they likely to survive in sufficient numbers and for sufficient time to cause subsequent infection?
- (iii) How significant is this infection route compared to all other potential infection routes?

We are concerned here with health risks to those who handle, prepare, or eat the crop after it has been harvested.

All types of pathogens in the waste being used may reach the field. Differing treatment technologies will remove different pathogens to various degrees, as discussed in chapters 9 and 10. Where effluent is used, the only treatment processes that will produce an effluent free or almost free from pathogens are waste stabilization ponds or conventional treatment followed by maturation ponds, land application, or sand filtration. Where sludge or night-soil are used, the only processes that will produce a totally pathogen-free material are batch thermophilic digestion, thermophilic composting, or drying with a retention time of two years.

If pathogens are not removed by these processes, they will arrive at the field. Survival times on soil are reviewed in chapter 7 and appendix V. From these data it can be generalized that survival for various pathogen types may be as follows:

<u>Pathogen</u>	<u>Survival time</u>
Viruses	Up to six months, but generally less than three months.
Bacteria	Sometimes over a year, but generally less than two months.
Protozoa	Up to ten days, but generally less than two days.
Helminth ova	Up to seven years, but generally less than two years.

Whether or not the pathogens become attached to the surface of the crops depends upon the method of application and the type of crop. Crops grown on or near the ground are almost certain to become contaminated. Where wastes are sprayed or poured on fields with growing crops, contamination is also certain. Crops may be protected by subsurface irrigation,

by drip or trickle irrigation where crops are not on the ground, by irrigation in furrows not immediately adjacent to the crops, or by similar techniques. Alternatively, wastes may only be applied prior to planting, or application may be discontinued one month before harvesting in the hope that all pathogens will die before the harvest. These methods may all be effective in preventing crop contamination when the waste applied has been treated. When a waste rich in pathogens is used, however, pathogens are likely to reach the crops, despite these protective devices.

Once on the crop, pathogen survival is not very long compared to survival in soil. Survival on crops is reviewed in chapter 7 and appendix VI. Survival for the various types of excreted pathogens on crop surfaces may be summarized as follows:

<u>Pathogen</u>	<u>Survival time</u>
Viruses	Up to two months, but generally less than one month.
Bacteria	Up to six months, but generally less than one month.
Protozoa	Up to five days, but generally less than two days.
Helminths	Up to five months, but generally less than one month.

The most lethal factors are dessication and direct sunlight. Survival may be expected to be very much shorter in dry, sunny climates than in humid, cloudy climates.

Survivals are quite sufficient, however, for viable pathogens (except perhaps protozoa) to be transported into markets, factories, and homes and subsequently infect those who handle, process, prepare, or eat the crop. A distinction is sometimes made between crops that are eaten raw (tomatoes, for instance) and those that are normally cooked (such as cabbage). Conservative and good public health policy, however, is to regard these similarly because, even if the cabbage is eventually cooked, those who handle and prepare it are still at risk.

The epidemiological literature indicates that, where an infection is highly endemic in a community and where poverty and squalor are found, the introduction of the particular pathogen into the home on contaminated vegetables or other crops may have a negligible impact on transmission. Where an infection is not widespread in a community, however, and where that community has improved standards of hygiene and housing, the introduction of crops into the home may be the major transmission route for some excreted pathogens. Thus, the significance of contaminated crops in disease transmission has been mainly emphasized in countries, such as Japan, Israel, South Africa, or Germany in the post-war period, where use of sewage or excreta on crops was combined with a relatively high level of hygiene and housing.

Let us illustrate this. Imagine a town of moderately wealthy people who live in houses with water connections and flush toilets. Outside of this town there is a village where people are extremely poor, houses have earth floors, water is drawn from an open well, and there is no adequate excreta disposal system. The main source of income for these villages is the cultivation of vegetables for sale to the town. The villagers also use the vegetables themselves as a subsistence crop. These vegetables are

fertilized by night-soil collected in the village and by sewage sludge obtained free of charge from the treatment works on the outskirts of the town. Let us consider infection with the roundworm, Ascaris lumbricoides. The prevalence of ascariasis in the town is only 8 percent, and the principal means of entry to the home of viable Ascaris ova is on the vegetables bought from the villagers. Transmission amongst the wealthy townsfolk is not taking place since their excreta are flushed away and high standards of hygiene prevail. The prevalence of ascariasis in the village is 68 percent. Transmission occurs intensively in the village and particularly in the home. The house floor and yard are contaminated with viable ova from the feces of infected children. Most transmission is quite unconnected to the contaminated vegetables, which the villagers also eat. If the supply of contaminated vegetables suddenly ended, the transmission of ascariasis in the town would be reduced very substantially, whereas the village would be unaffected.

Ascariasis was selected for this example because, as an extreme example of persistence, it illustrates the point most effectively. For other pathogens things may be more complex, but the same principles may apply. For instance, if cholera was introduced to the area and the vegetables became contaminated with Vibrio cholerae, the contaminated vegetables might cause an epidemic in the town and might be the major route of transmission. The village would, in all probability, experience a cholera outbreak in any case, and the vegetables might make little contribution to this. An outbreak of cholera in Jerusalem in 1970 manifested epidemiological characteristics very similar to this hypothetical example (Cohen et al., 1971).

Foodstuffs for animal consumption

A widespread use of sewage effluents, sludge, and night-soil is their application to pastures or to fodder crops that will subsequently be fed to animals. For instance, in the United Kingdom 16 percent of all sewage works sludge is applied to grazing land. Of this, 29 percent is applied raw, while 71 percent is applied following digestion (Department of the Environment, 1977). Various reports indicate that a wide variety of animal pathogens may be encountered in sewage and night-soil from time to time. They include:

<u>Viruses causing:</u>	<u>Bacteria causing:</u>	<u>Helminths causing:</u>
Foot and mouth disease	Anthrax	Beef tapeworm
Procine encephalomyelitis	Brucellosis	
Rabies	Leptospirosis	Pork tapeworm
Rinderpest	Salmonellosis	
Swine fever	Tuberculosis	

Despite this apparently alarming array of pathogens it is clear that, in most cases, the sewage or sludge contains insignificant numbers of the pathogens and plays a negligible role in the transmission of the disease. There are three exceptions, however, for which the use of human wastes on pastures or fodder crops may promote the transmission of diseases of significant public health or veterinary importance ^{1/}. These are: beef tapeworm, salmonellosis, and tuberculosis

Beef tapeworm (Taenia saginata) is by far the most important of these. This helminth circulates between men and cattle, and infection only continues when cattle eat Taenia eggs that humans have excreted. Therefore, any treatment, disposal, or reuse technology that brings cattle into direct contact with human excreta may promote the transmission of the disease, unless adequate treatment is provided. Taenia ova are very hardy and are surpassed only by Ascaris ova in their ability to survive outside the host. They may survive in soil or on pasture for over six months. Their removal from effluent will require either the use of waste stabilization ponds or tertiary treatment in the form of sand filtration, land application, or lagooning. Removal from sludge requires either a thermophilic process or retention for over a year. It should be noted that the prevention of cattle exposure to untreated human excreta is important because Taenia saginata is an important health problem in both man and cattle in highly endemic areas.

Sewage effluents, sludges, and night soil from all large communities in both rich and poor countries will contain substantial numbers of salmonellae. Figures of 10^4 per liter of raw sewage and raw sludge are not uncommon in Europe. These salmonellae may reach pastures or fodder crops and may infect animals. Animals may subsequently infect people. Required infective doses are high, however, and Salmonella infections are transmitted amongst cattle in many other ways. There is no clear evidence that cattle grazed on pastures fertilized with wastes are more at risk from salmonellosis than other cattle.

Wastes from institutions treating tuberculosis patients, or from industries such as dairies and abattoirs that handle tuberculous animals, will almost certainly contain Mycobacterium tuberculosis. Studies in Denmark (Jensen, 1954) showed tubercle bacilli in the sewage produced by towns with tuberculosis sanatoria. Tubercle bacilli were also demonstrated in the effluent, digested sludge, and five-week-old dried sludge from the treatment plants of these towns.

Chlorination will remove tubercle bacilli from sewage effluent, although they are more resistant than E. coli. In one experiment, an

1. We have omitted pork tapeworm (Taenia solium) from this discussion. Although the use of human wastes on fodder crops fed to pigs would undoubtedly promote the transmission of this tapeworm, in practice the life cycle usually depends on pigs gaining direct access to human feces.

applied dose of 10 milligrams per liter of chlorine removed tubercle bacilli from an effluent having 11-63 milligrams per liter of BOD₅ (Jensen, 1954). Greenberg and Kupka (1957), however, concluded that a chlorine dose of 20 milligrams per liter and a contact time of at least two hours were required to remove tubercle bacilli from a well-oxidized effluent. Sludge has been recorded as containing at least 7×10^4 tubercle bacilli per gram of dry matter, and fifteen months on a drying bed were required to remove these in Denmark. Sludge may also be disinfected by thermophilic processes, and tubercle bacilli are killed after twenty minutes at 66°C.

In summary, tubercle bacilli may be numerous in sewage, sludge and night-soil and they are more persistent and resistant to disinfection than the enteric bacteria. The epidemiological significance of this is quite clear. There is a reported case of human tuberculosis following children falling into a river polluted by sanatorium wastes (Jensen, 1954). It remains most doubtful, however, whether transmission of either human or bovine tuberculosis is significantly affected by exposure to wastes or polluted waters. Those wishing to read further may consult Greenberg and Kupka (1957), Heukelekian and Albanese (1956), Jensen (1954), Maddock (1933), Pramer, Heukelekian, and Ragotzkie, (1950) and Williams and Hoy (1930).

Other products

Fecal wastes may also be used to produce crops not intended for consumption by animals or humans. Examples are tree cultivation for timber production, tree cultivation for beautification or to control desertification, the irrigation of parks, and the growth of commercial crops such as cotton or coconuts (Sundaresan, Muthuswamy, and Govindan, 1978). These reuse technologies pose health hazards of a mainly occupational type. Workers in the fields, and in the factories where the crops are processed, are at risk. These risks are discussed in the next section.

One reuse system that is worth special mention is the practice, now widespread in the Middle East and elsewhere, of using effluents to irrigate parks, lawns, central reservations on highways, and other open amenity areas. Effluents are sometimes brought by tanks from the treatment works to the city center for this purpose. Where conventional treatment works without tertiary processes are used, this practice involves great risk to the public health and should be condemned. It is only acceptable using the effluents from waste stabilization ponds or tertiary treatment processes and, even then, very careful monitoring of their pathogen content is required. Compared to other reuse techniques described in this chapter, the irrigation of amenity areas is a high-risk activity.

Occupational hazards

A health hazard common to all these agricultural reuse practices is the risk to those who actually work in the fields. Although there is very limited epidemiological evidence to demonstrate the fact, it is likely that those who work in fields contaminated by excreted pathogens are at greater risk than others. If they bring these infections back into their homes and subsequently infect their families, a measurable difference

in their health compared to nonagricultural workers may not be apparent. Also, in many agricultural communities, practically the whole population works in the fields at some time of the year, and so all may be exposed to the risk (although not equally so).

The only sure way to protect the health of the agricultural workers is to use only wastes that are pathogen-free, or nearly so. Once again this means only effluents that have undergone waste stabilization pond treatment or conventional treatment followed by land application, sand filtration, or lagooning. Similarly, for sludges or night soil it requires either batch thermophilic processes or very protracted drying or storage periods (over one year).

A special problem regarding the health of agricultural workers occurs when spray irrigation of sewage effluent is used. Aerosol droplets containing enteric bacteria have been reported to travel up to 1.2 kilometers (Adams and Spendlove, 1970), and bacteria are more infective (i.e., have a lower infective dose) when inhaled than when ingested (Sorber and Guter, 1975). Aerosol particles may also carry viruses and cause infection by inhalation in like manner (Melnick, Gerba, and Wallis, 1978). There is cause for concern that spray irrigation leads to aerosol dissemination of enteric bacteria and viruses and could lead to infection by inhalation of those who work in the fields and live within 1 kilometer of them. A study in Israel (Katzenelson, Buim, and Shuval, 1976), showed that the populations of kibbutzim that practised spray irrigation with waste stabilization pond effluent had a higher incidence of shigellosis, salmonellosis, typhoid, and infectious hepatitis than kibbutzim practicing no form of wastewater irrigation. This could be attributed either simply to the use of wastewater in agriculture or, additionally, to the spray technique promoting aerosol transmission. A further disadvantage of spray irrigation is that it often causes ponding, and this may promote increased mosquito breeding.

A specific occupational hazard of agricultural reuse of excreta is schistosomiasis. Of the various species, the one with a transmission that has been related to deliberate reuse rather than incidental pollution is Schistosoma japonicum. The eggs survive in feces for over a week, so that when the excreta are applied fresh to irrigated rice fields containing the amphibious snail hosts, the snails may become infected. This occurs in several parts of Southeast Asia, most notably until recently in China. After the schistosomes have developed within the snails, larvae that can bore through the human skin are shed into the water, thus creating the occupational risk to the farmers. The other snail-transmitted flatworm larvae encyst on vegetables or in fish and crabs, so that they infect the consumer rather than the agricultural worker.

The excreta can be rendered free of live schistosome eggs by suitable treatment. In China the night soil is stored in jars for two weeks when the eggs have died from a combination of high pH, bacterial action, and temperature. This simple approach is possible because there is a high degree of community organization and a very long tradition of viewing excreta as a resource to be conserved and managed.

Summary

There is now a substantial literature on the health implications of agricultural reuse. There are also several comprehensive reviews available on the topic that some readers may find of additional value (for instance, Benarde, 1973; Gerba, Wallis, and Melnick, 1975; Hickey and Reist, 1975; Petrik, 1954; Rudolfs, Falk and Ragotzkie, 1951; Shuval, 1977b; Sorber and Guter, 1975; Wiley and Westerberg, 1969; WHO, 1973).

It is clear from the above discussion that a desirable public health policy would be to require the highest quality standards for all wastes reused in agriculture. For effluents, this standard might be expressed in terms of a fecal coliform count of less than 100 per 100 milliliters (WHO, 1973). Such a standard, however, may tell one little about the effluent content of viruses, protozoa, and helminth ova, especially following chlorination of the effluent, which will be considerably more lethal to enteric bacteria than to other types of excreted pathogens (see section 10.7). As we discuss elsewhere (chapter 6), E. coli is also an inappropriate indicator for the quality of treated sludge or night-soil. For these materials the concentration of Ascaris ova is a better guide to overall pathogen content (see section 6.5), and Ascaris criteria have been adopted in China (McGarry and Stainforth, 1978).

The imposition of stringent quality standards on effluents (say, <100 fecal coliforms and fecal streptococci per 100 milliliters) restricts the range of treatment technologies considerably. Fortunately, waste stabilization ponds are both able to meet these standards and are a low-cost and appropriate form of waste treatment in hot climates (see chapters 8 and 10). Irrigation with waste stabilization pond effluent is therefore a recommended practice.

The imposition of stringent quality standards on sludge or night soil (say, <10 viable Ascaris ova per 100 grams) poses greater problems. Such a standard can only be achieved by well-managed thermophilic digestion, composting, or by very long retention times (>1 year). Figure 19 indicates that a second best system would be batch mesophilic digestion followed by several months in drying beds. An alternative for night-soil reuse is to place it in a facultative stabilization pond and produce a very small effluent flow for irrigation or fish farming.

Thus we conclude that stringent quality standards may be set upon waste intended for agricultural reuse, and that these standards may be achieved by relatively simple and low-cost technologies. Major pathogen removal problems will only be encountered where conventional sewage treatment plants are in use. Such plants produce both an effluent and a sludge that are rich in pathogens and that require expensive additional treatment (chapter 10) before they can be recommended for unrestricted agricultural reuse.

11.3 AQUACULTURAL REUSE

Human excreta may be reused to promote the growth of aquatic flora and fauna, a practice known as aquaculture. Three main types of aquaculture are found: (i) fish farming; (ii) algal production; and (iii) macrophyte production.

Fish Farming

The raising of fish in ponds enriched with human and animal excreta has a long tradition. In China and some other Asian countries, it has been practiced continuously for many centuries. It is reported from ancient Egypt and was widely practised by European monasteries in the Middle Ages.

The controlled addition of wastes to the ponds causes a large population of bacteria to thrive, and these in turn promote communities of phytoplankton (algae) and zooplankton, which graze on the algae. In such an environment some fish, notably carp and tilapia, grow rapidly. Different fish species occupy different ecological niches; some feed on large algae, some on small algae, some on zooplankton, some in the bottom layers, and some nearer the surface. For this reason, polyculture (the growing of several species in the same pond) is widely practised (Sundaresan, Muthuswamy, and Govindan, 1978). The major advantage of growing fish in this way is that it greatly enhances the total fish yield.

Fish may be grown in ponds enriched with sewage or night soil. Where sewage is used it is usually pretreated, diluted, or both. An appropriate system is to grow fish in the maturation ponds of a chain of waste stabilization ponds. Fish (except the air-breathing varieties) cannot be grown in highly polluted waters because the BOD exceeds the oxygen supply, the water becomes deoxygenated, and the fish die. Night soil is commonly added to ponds either by locating latrines directly over them or by delivering night soil in carts or trucks.

In addition to promoting productivity, fish growing in waste-enriched ponds has other advantages. From the point of view of sewage treatment, nutrient removal is improved because nitrates and phosphates concentrate in the food chain and are removed during harvesting. The bacteriological quality of the sewage may also improve because the presence of fish appears to raise the oxygen levels and the pH (generally over 8.50), both of which increase the death rate of enteric bacteria. Further, there is some evidence that fish reared in sewage are less prone to disease than others.

There are three distinct health problems associated with fish farming in excreta-enriched ponds:

- (i) the passive transference of animal pathogens by the fish that become contaminated in the polluted water;

- (ii) the transmission of certain helminths that have life cycles including fish as an intermediate host; and
- (iii) transmission of other helminths with a life cycle involving other pond fauna, such as snail hosts of schistosomes.

The first of these problems is a cause for concern throughout the world, whereas the second and third apply only in areas where particular eating habits are found and/or where the helminths concerned are endemic.

Fish may passively carry human pathogens in their intestines or on their body surfaces, and these pathogens may subsequently infect people who handle, prepare, or eat these fish. There is little risk to fish eaters except in areas where fish are eaten raw or partially cooked. Thorough cooking will destroy all excreted pathogens. Those who handle or prepare the fish, however, are at risk whatever the local eating habits.

Most studies on pathogen carriage by fish are related to fish caught in sewage-polluted seawater or rivers. The principles, however, will apply to fish farming also. There is abundant evidence that the intestinal bacteria of men and animals are not the normal resident flora of fish. Nevertheless, fish raised in contact with these bacteria may acquire substantial numbers of them on their bodies and in their intestines; fecal coliforms, fecal streptococci, and salmonellae are easily isolated from fish grown in polluted waters. A concentration effect is discernible and concentrations of enteric bacteria in fish intestines tend to be higher than in the water in which the fish live. There is even evidence of their ability to multiply in the intestines of some fish.

It is quite possible for pathogenic bacteria carried by fish in this way to infect people. It is equally possible for the contaminated fish to infect animals fed on fish meal (especially with Salmonella), and people who eat these animals may subsequently be infected. In practice, however, it is equally likely that the fish become infected after harvesting and during handling, transportation, and processing. The major known fish-associated outbreaks of salmonellosis in animals and man have been associated with contamination after harvesting. It remains quite possible, however, for fish to carry bacterial pathogens passively from enriched ponds to men and thereby to cause infection. The survival of enteric bacteria in fish intestinal material or in fish transferred to clean water is generally reported as less than seven days, with some reports of up to fourteen days. Vibrio cholerae survival in refrigerated fish of up to fourteen days is reported.

There is little information about the carriage of nonbacterial pathogens by fish. One must assume that viruses, protozoan cysts, and helminth ova could all be carried, and even concentrated, in or on fish and thereby infect fish eaters or handlers. Helminth

ova will tend to settle to the pond bottom and therefore may only be ingested by fish (such as the common carp, Cyprinus carpio) that are bottom feeders.

The second, and quite distinct, health problem associated with fish farming is the transmission of worms parasitic to man and having a fish intermediate host. The major examples are: Clonorchis sinensis (oriental liver fluke), Diphyllbothrium latum (fish tapeworm), Heterophyes heterophyes, and Metagonimus yokogawai. Of these, Heterophyes and Metagonimus are not of major public health importance; they are primarily parasites of dogs and cats rather than man, and Heterophyes only infects fish in brackish water. Diphyllbothrium infects pike, perch, turbot, and other fish found in lakes or rivers. It is not associated with enriched ponds. Clonorchis sinensis, however, and the related species Opistorchis viverrini and O. felineus, are associated with excreta-fed fishponds and are intensively transmitted where fish are eaten raw or partially cooked. Infection occurs principally in China, Korea, Taiwan, and Vietnam and the prevalence can reach 60 percent locally. Fish cooking must be thorough to kill the encysted larvae and most fish preservation and pickling techniques have little effect.

Where fish are grown in pretreated or presettled sewage, Clonorchis eggs will have settled. Transmission is therefore associated with the direct enrichment of ponds with night soil or raw sewage. Clonorchis eggs are fragile and die if stored for a few days in night soil. Seven days storage prior to pond enrichment could therefore be a sound strategy for the control of this infection. It must be noted, however, that there are other important vertebrate hosts apart from man (such as dogs and cats), so that the control of human excreta may only partially reduce transmission.

Third, it is possible that schistosomiasis transmission may occur in the ponds and infect the fishermen. This would require that fresh ova or cercariae reach the ponds, and this may be prevented by using only sewage treated in stabilization ponds or stored night soil.

To summarize, fish farming using excreta or sewage carries with it the hazard of passive carriage of a range of pathogens and of Clonorchis and schistosome transmission in some parts of the world. Control measures are as follows:

- (i) enrich ponds only with treated sewage or stored night-soil or sludge;
- (ii) allow fish to reside in clean water for several weeks prior to harvesting;
- (iii) clear vegetation from pond banks to discourage the molluscan intermediate hosts of Clonorchis and the schistosomes;
- (iv) promote good hygiene in all stages of fish handling and processing; and
- (v) discourage the consumption of undercooked fish.

Algal Culture

Instead of growing fish in waste-enriched ponds with large algal populations, it is possible to harvest the algae directly. This is as yet an experimental technique, but it may well see large scale application in the coming decade. The advantage is that harvesting at a lower trophic level ensures far higher yields of biomass and protein. For instance, the best yields to be hoped for from sewage enriched fishponds are in the order of 10,000 kilograms per hectare yearly (Sundaresan, Nuthuswamy, and Govindan, 1978), whereas algal production in high rate ponds may be up to 150,000 kilograms per hectare yearly. The algae are approximately 50 percent protein, and thus protein yields of 75,000 kilograms per hectare yearly are achieved. This compares favorably with protein yields from, for instance, rice (56 kilograms per hectare yearly), corn (270 kilograms per hectare yearly) or soya bean (650 kilograms per hectare yearly)(McGarry, 1971).

Algae may be harvested by flocculation with lime or aluminium sulphate followed by flotation (McGarry, 1971), or they may be partially removed by microstraining. Oswald et al. (1978) report harvesting algae from shallow ponds in the Philippines by simple sedimentation with a production of 47,000 kilograms per hectare yearly. These various methods produce an algal paste or sludge containing 8-10 percent solids. This is then sun dried.

High rate ponds have a short retention time of around one day. Pathogen removal is therefore minimal, and the harvested algae will be rich in excreted viruses, bacteria, protozoa, and helminth ova. The key removal process is the sun drying. If the algae are dried to less than 5 percent water, pathogen removal will be completed. If not, pathogens will survive to a degree depending upon the time of drying, the final moisture content achieved, and the sunlight intensity. There are no data on pathogen survival on drying algae, but we speculate that protozoa will be rapidly removed (in a few weeks) and that bacteria may be killed by algal toxins as well as other factors. Viruses and helminth ova will be long-term survivors, with the latter lasting for a year or more if moisture content stays above 10 percent.

The health hazards involved in the reuse of this algae will depend upon the type of reuse. If the algae are fed to cattle the major requirement will be elimination of Taenia saginata, Salmonella spp., and Mycobacterium tuberculosis (see above). If they are fed to chickens the major requirement may be Salmonella removal. If they are fed to people, as in Japan, they will require thorough disinfection prior to packaging and marketing.

Macrophyte culture

Around the world, but especially in Southeast Asia, many water plants are used as food or animal feed. Some of these are harvested wild, while some are cultivated. Plants include water spinach (Ipomoea aquatica), water-chestnut (Eleocharis dulcis or E. tuberosa), water hyacinth (Eichhornia crassipes), water bamboo (Zigania spp.), water calthrop (Trapa spp.), and lotus (Nelumbo nucifera). Some of these plants (for instance, water spinach) are intensively fertilized with human and animal wastes while others are grown in water that

may be incidentally contaminated (National Academy of Sciences, 1976). The health hazards associated with these aquacultural practices are of three types.

First, there is the occupational risk to those who work in the water, especially where intensive use of night soil is practised. They may accidentally swallow pathogens, they may carry pathogens back to their homes on their clothing or their bodies, and they may become infected percutaneously with schistosomiasis in areas where the disease is endemic and where the intermediate host snails are resident in the ponds or flooded fields.

Second, the harvested plants may be heavily contaminated with pathogens and may infect those who harvest, handle, prepare, or eat them. Some of these plants are eaten raw, for instance, water chestnut in China.

Third, the parasitic fluke Fasciolopsis buski is locally important in some parts of Asia and may infect 10 million people. This worm has a life cycle from man (or pig or dog) to snail to water plant to man. Animals or men become infected when they eat the encysted metacercariae on water plants, especially Eleocharis, Eichhornia, Trapa, and Zigania.

Control of these health problems can only be effected by the treatment of night soil and other wastes prior to discharge or prior to use as a fertilizer for aquatic plants.

Recently, attention has focussed upon the use of water hyacinth in waste treatment and recycling systems (Wolverton and MacDonald, 1976). Water hyacinth removes nutrients, metals, and phenols from wastewaters (Cornwall et al., 1977). The hyacinth can be harvested and used as animal feed, processed to produce fertilizer, or used to generate methane (biogas, see section 11.4). If the water hyacinth is employed, the ecological consequences of its escape into irrigation systems must also be considered. Such systems for intense recycling of wastes are usually fed by sewage but could be fed by night soil or sludge. The health requirement for a particular works would have to be derived from a consideration of exactly what type of reuse processes were in operation and the degree of mechanization incorporated in the plants.

11.4 BIOGAS PRODUCTION

When organic wastes are digested anaerobically, a mixture of methane, carbon dioxide, and other gases is given off. This gas has become known as "biogas" and can be produced on various scales by various different technologies. In conventional sewage treatment works, anaerobic sludge digestion produces biogas and this is sometimes used to heat the digesters or for some of the other energy needs of the works. The term "biogas production," however, is usually used to describe the production of methane on a small scale by individual farmers, communes, or rural institutions in hot climates (Figure 26).

Figure 26 - Two Designs for Biogas Plants

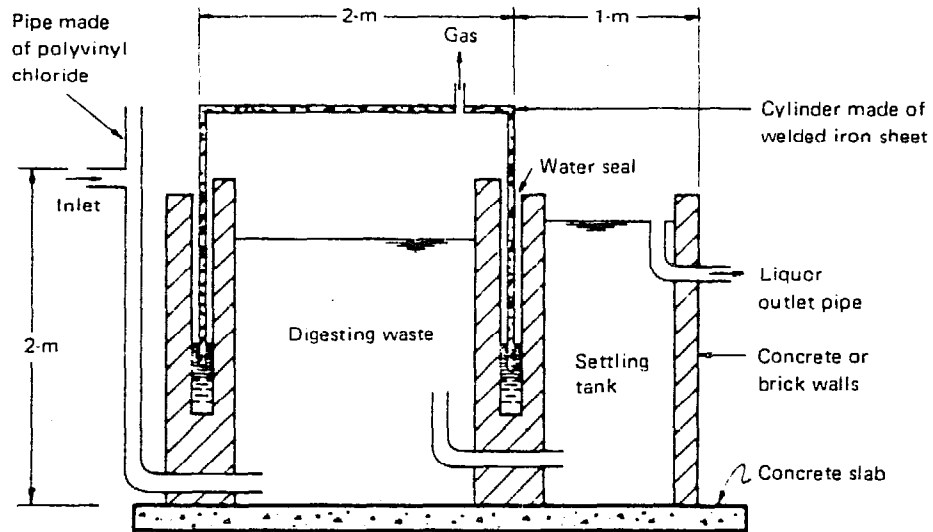

Biogas plant from South Pacific

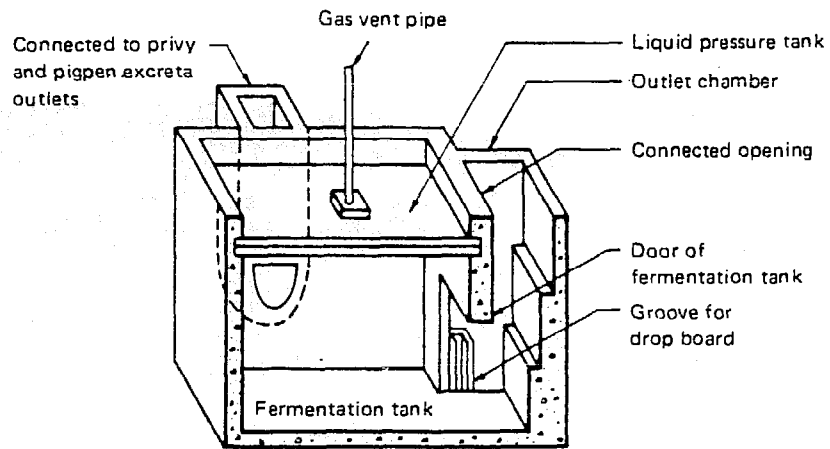

Biogas plant from China

Sources: South Pacific, Solly (1976); China, McGarry and Stainforth (1978).

Biogas plants are found in large numbers in China, and it is probably in this country that the technology has become most developed (McGarry and Stainforth, 1978). Significant numbers are also in operation in India, Korea, and Taiwan. The biogas plants are fed with diluted animal feces, with or without human excreta and with or without vegetable refuse. The effluent slurry is reused in agriculture, or it could be used to enrich fishponds. The gas is used primarily for domestic cooking and lighting. The dung from one medium sized cow, or similar animal, may produce around 500 liters of gas per day and the calorific value of this gas may be around 4-5 kilo calories per liter (McGarry, 1977). In contrast, human excreta only produce 30 liters of biogas per person daily. The process is very sensitive to temperature. In the mesophilic range, optimum gas production occurs at around 35°C. In rural applications digesters are not heated (although they may be lagged or buried), so they operate around ambient temperatures. Gas production falls off considerably at lower temperatures and may be negligible below 15°C.

Two designs of biogas units are illustrated in Figure 26. For further details of biogas technology the reader may consult Freeman and Pyle, 1977; McGarry, 1977; McGarry and Stainforth, 1978; and Rybczynski, Polprasert, and McGarry, 1978.

The health problems associated with biogas plants come entirely from the reuse of the slurry, as the gas production itself has no health implications--unless the digesters blow up or the gas starts a fire. Average retention times in biogas plants are commonly short (five to thirty days), and the operation is usually continuous rather than batch. Pathogen removal will therefore be considerably less effective than in conventional sludge digestion processes (see section 10.3 and Figures 18 and 19). Protozoan cysts should not survive, but pathogenic viruses, bacteria, and helminth ova may be expected in the effluent slurry in convenient concentrations.

There is little information from the field on the effluent quality of biogas plants. Data from China (McGarry and Stainforth, 1978) indicate an average of 15,000 helminth ova, four hookworm ova, and 8×10^7 E. coli per liter of biogas plant effluent. In the same report, it is stated that survival times for Salmonella, Shigella, spirochaetes, schistosome ova, and hookworm ova in the anaerobic environment of the biogas tank are up to forty-four days, thirty hours, thirty hours, forty days and seventy-five days, respectively. Therefore, for a plant with a retention time of ten to thirty days, one might expect salmonellae, schistosomes, and hookworms in the effluent, but not shigellae or spirochaetes. Ascaris ova will survive considerably longer than hookworm ova, and therefore may also be anticipated. Indeed, it is likely that the major proportion of the 15,000 ova per liter mentioned above were Ascaris.

Thus, the effluent slurry from a biogas plant is unlikely to be significantly less pathogenic than raw sludge. Its direct reuse on crops is therefore not advised (see section 11.2). It may,

however, be reused in agriculture following very prolonged drying (>1 year) or following composting (see section 9.5). The area of land required for prolonged drying will be so great that composting will generally be the preferred treatment method. Biogas plant effluent may also be used to enrich fishponds. Clonorchis sinensis ova will be eliminated in the plant and so the health hazard involved is the passive transmission of pathogens in harvested fish (see section 11.3).

CHAPTER 12

DISCHARGE OF EFFLUENTS

In chapter 11 we expressed the view that sewage effluent, sludge, and night soil are important natural resources that should be reused wherever possible. There will be occasions, however, when the most economically or environmentally appropriate solution is to discharge wastes to rivers, to lakes, to the sea, or to the groundwater. The health implications of each of these alternatives are discussed in this chapter.

12.1 DISCHARGE TO RIVERS AND LAKES

The survival of pathogens in fresh water is reviewed in chapter 7. Survival times are considerable for all groups of organisms and they increase in the order protozoa, bacteria, viruses, and helminths. Clearly, pathogens may travel substantial distances following discharge into fresh water.

Pathogens discharged into rivers and lakes may contaminate fish in the manner described for marine discharge in section 12.2. Where discharge is to a river, the pathogens may be carried to its mouth where they may infect shellfish.

There are, however, two more important health problems associated with river or lake discharge:

- (i) pathogens may be ingested by waterside populations that use the river or lake water for domestic purposes;
- (ii) discharge to fresh water may promote the transmission of those parasitic worms that have aquatic intermediate hosts.

People who use a polluted river or lake for their drinking water may become infected by pathogens that have been previously discharged. Viral, bacterial, and protozoal pathogens may all be transmitted in this way, although where these infections are endemic in the community, the magnitude of this waterborne transmission may be minor compared to other more direct transmission occurring within the community (see chapters 4 and 5). Poor and seasonally arid countries are especially at risk from river or lake pollution of this kind for two reasons. First, the waterside dwellers may have no alternative potable water supply and therefore be compelled to use polluted water. Second, at some period of the year river flows may be very low or nonexistent so that the discharged effluent will receive little or no dilution. These factors make it essential to guard against substantial pathogen pollution of lakes and rivers.

The excreted helminths that require one or more intermediate aquatic hosts are: Clonorchis sinensis, Diphyllobothrium latum, Fasciola hepatica, Fasciolopsis buski, Heterophyes heterophyes, Metagonimus yokogawai, Paragonimus westermani, and Schistosoma spp.

Fasciola is primarily a parasite of cattle and sheep and is associated with wet pastures and small streams. Fasciolopsis is

associated with the cultivation and ingestion of water plants (see section 11.3). Heterophyes and Metagonimus are of limited public health importance and have a very restricted geographical distribution. It is thus Clonorchis, Diphyllbothrium, Paragonimus and Shistosoma infections that are primarily associated with effluent discharges to rivers and lakes.

Clonorchis sinensis, and the related species Opistorchis felineus and O. viverrini, are transmitted from man (or dog, cat, and the like) to snail to fish to man. They are especially associated with fish farming in ponds enriched with excreta (see section 11.3). Diphyllbothrium latum is transmitted from man (or dog, etc.) to copepod to fish to man. It is especially prevalent in lakeside areas of temperate countries. Paragonimus westermani is transmitted from man (or many other animals) to snail to crab or crayfish to man. These three parasites may all be controlled by preventing untreated human excreta from reaching bodies of water where the intermediate hosts are found and by persuading the community not to eat undercooked fish, crabs, and crayfish. In the case of Clonorchis and Paragonimus, asexual multiplication takes place in the snail so that one viable miracidium infecting a snail can give rise to many infected fish or crabs and thus many infected people. This means that the discharge of the parasite ova in the effluent needs to be cut to very low levels if transmission is to be reduced greatly. In all cases, animals other than man act as definitive hosts so that the management of human excreta can never alone guarantee the cessation of transmission. Keeping all untreated human wastes out of rivers and lakes, however, should have a dramatic impact in most endemic areas.

Schistosome worms are transmitted from man to snail and directly to man through his skin. The discharge of inadequately treated wastes to rivers and lakes is a major factor in the transmission of these important parasites. Adequate treatment of all wastes before discharge should be helpful in the control of the fecal species (S. mansoni and S. japonicum) but will have less effect on S. haematobium, the ova of which are passed in the urine, because people may freely urinate near water. Once again, multiplication takes place in the snail so that a very great reduction in the number of viable ova reaching the water is necessary before a marked reduction in transmission may be expected.

12.2 DISCHARGE TO SEA

Night soil or raw sludge are often taken out to the open sea by boat and dumped or, less commonly, are dumped from the shore. Night-soil or sludge dumping in the open sea should pose no significant health problems, while dumping from the shore is such an offensive practice that it should never feature in any well-designed system. We therefore concentrate here on the more usual practice of discharging effluents from sewage treatment facilities into the sea near the shore.

The discharge of sewage effluent into coastal waters can create two kinds of health problems:

- (i) the risk of contamination of fish or shellfish that may subsequently be eaten; and
- (ii) the risk of contaminating bathing areas and beaches.

Enteric viruses and bacteria discharged into seawater survive for considerably shorter periods than they do in fresh water. E. coli, Salmonella, and other enteric bacteria are seldom reported to survive for more than seven days. Survival may be a great deal shorter in warm waters, and 90 percent reduction by sedimentation and mortality has been recorded in under one hour. Enteric virus survival in seawater appears to be very variable but is generally greater than bacterial survival and may extend for over four months (Melnick, Gerba, and Wallis, 1978). Much review material on this topic is contained in Gameson (1975). Protozoan cysts and helminth ova do not experience any particular lethal effects in seawater and survival is similar to that in fresh water. They do, however, tend to settle and so present little health hazard.

Fish and shellfish may be contaminated by human enteric viruses and bacteria if they live in polluted seawater. The travel of more than a few kilometers of pathogenic pollution from sewage outfalls is not normally reported. Fish caught in the littoral zone may well have enteric bacteria and viruses on their body surfaces and in their intestines. These may survive for up to seven days, in the case of bacteria, and considerably longer in the case of viruses. They may infect humans who handle or eat them. They may also infect animals fed on fish meal, and these in turn may infect humans. A more common hazard, however, is the contamination of fish after they are caught, and most fish-associated outbreaks of salmonellosis or typhoid have been linked to this form of contamination.

A more serious problem is the contamination of edible shellfish. Mussels and oysters are grown along coasts and in estuaries where the salt concentration is 0.8-3 percent (compared to 3.5 percent in the sea). They therefore live in the marine environment most exposed to pollution from outfalls and from contaminated river water. Shellfish filter water to feed and concentrate enteric bacteria and viruses in their tissues. Salmonella, including S. typhi, and enteric viruses have frequently been isolated from shellfish at concentrations well above those found in the surrounding seawater. Outbreaks of polio, hepatitis A and diarrheal disease have all been associated with the ingestion of shellfish originating from polluted water.

Shellfish can be cleaned out by placing them in clean water. Dechlorinated chlorinated water is often used. Chlorinated water is not effective because it discourages the shellfish from pumping and feeding and so will not flush out viruses or bacteria lodged in the animal's tissue. It appears that forty-eight hours in clean water is sufficient to cleanse the shellfish of bacterial contaminants but much longer periods may be required for virus removal (Melnick, Gerba, and Wallis, 1978).

A related problem is that of acute gastroenteritis caused by Vibrio parahaemolyticus. V. parahaemolyticus has been reported as a cause of acute diarrhea in several countries and, in Japan, it may be the single most common cause. The bacterium occurs widely in nature and is

not restricted to the animal intestine. It is a halophile and has been frequently isolated from seawater, estuarine water, brackish lagoon water, marine sediments, fish, shellfish, crabs, and prawns (Vanderzant and Nickelson, 1973). Outbreaks of V. parahaemolyticus diarrhea in man have usually been associated with the ingestion of infected seafood and the organism may also be a pathogen of marine fish and shellfish. It remains unclear to what degree disease outbreaks in man may be associated with pollution of marine waters by human wastes. It is noteworthy that pathogenicity in man is particularly associated with those strains of V. parahaemolyticus that produce a thermostable haemolysin (the Kanagawa phenomenon). In a study in Togo, such strains were frequently found in patients with acute gastroenteritis (92.6 percent), but rarely in water (two of 117 isolates) or fish (one of 134 isolates) (Bockemuhl and Triemer, 1974).

The risk to bathers of the marine discharge of sewage exists in theory but has been difficult to demonstrate epidemiologically (Gameson, 1975). It is a minor public health problem for the indigenous population of most developing countries. It may, however, be perceived as an important problem by tourists and so have significant economic consequences.

12.3 DISCHARGE TO GROUNDWATER

Effluents and liquid wastes are frequently discharged to groundwater. This usually occurs unintentionally, as when soakaway effluent or pit latrine seepage percolates down to reach the water table. It can also occur because of seepage losses from the base of waste stabilization ponds or when effluents are discharged into low flow or no flow streams in arid areas that are losing flow to the ground. In some countries where groundwater resources are being deliberately conserved or augmented, treated effluents may be recharged to groundwater as a means of indirect recycling.

In considering the health implications of waste discharge to groundwater there are two central questions:

- (i) How far do the pathogens move vertically and horizontally from the point of discharge?
- (ii) For how long are they able to survive?

The movement of protozoal cysts and helminth ova can be expected to be very limited because their size will cause them to be retained. It is therefore only viral and bacterial movement and survival that are of interest.

Studies on bacterial movement through soil and rock indicate normal maximum travel distances of up to 30 meters in sand and fine soils and up to several hundred meters in gravel or fractured rock. Despite their tendency to become adsorbed onto soil particles, viruses may travel through soil for longer distances than bacteria. Travel through sandy soils of up to 60 meters has been recorded and through fissured rock of up to 1.6 kilometers. It has been recently reported that polioviruses are more readily retained in soil than certain strains of coxsackie and echoviruses (Melnick, Terba, and Wallis, 1978). Retention does not necessarily imply inactivation.

It must be noted that, when moving through soils, the great majority of bacteria and viruses are retained in the first meter and that it is only a very small fraction that are able to travel more than 10 meters.

Bacterial survival in groundwater is generally reported extending up to five months with most reduction taking place in the first few days. Fecal coliforms survive for longer than salmonellae and can multiply in the presence of nutrients as when effluent is reaching the groundwater. Virus survival may be for six months or more.

In areas where there are many pit latrines, soakaways, unlined stabilization ponds, or a recharge system there will always be a risk of pathogenic viruses and bacteria reaching the groundwater. In pit latrines, soakaways, and ponds the waste-soil interface quickly becomes clogged with solids and thus more effectively retains these microorganisms. The risks to health occur when the contaminated groundwater is used as a drinking water source. Nonetheless, the pathogen content of polluted groundwater will, in general, be very much lower than that of surface waters in the same area. Where untreated water is being used for domestic purposes there will therefore be a lower risk from wells than from nearby streams or ponds. Where water is chlorinated, the bacterial pathogens will be effectively destroyed.

Special vigilance is required where dense populations use untreated well water as their only domestic source and where there is widespread use of soakaways or pit latrines. If routine water quality monitoring demonstrates a significant groundwater pollution problem, it is necessary either to supply piped water of better quality or to change the excreta disposal method. The former solution will in general be less costly and more practicable.

12.4 NITRATES

This report is about health problems related to biological agents contained in excreta. It would be inappropriate, however, not to mention the problem of nitrate accumulation that can occur as a result of waste discharge to rivers, to lakes, or to the groundwater. Nitrates are an end product of the oxidation of many nitrogenous compounds. Nitrate levels may be high in lakes and groundwater that receive continuous discharge of raw or treated sewage and in rivers that provide insufficient dilution. High nitrate levels in surface and groundwater may also derive from surface runoff water that has picked up organic material and nitrates from soil or agricultural fertilizers.

Nitrate levels of over 100 milligrams per liter of NO_3 have been associated with clinical methemoglobinemia in bottle-fed infants. The nitrates are reduced to nitrites in the intestine and thence enter the bloodstream, where they oxidize hemoglobin to methemoglobin. This molecule is unable to transport oxygen and thus, if too great a proportion of methemoglobin is created, serious anoxia and cyanosis may result, sometimes proving fatal. This condition is rare, apparently restricted to infants (and chiefly those under six months of age), and is not experienced by breast-fed infants who ingest no high nitrate water. Recent studies in Israel (Shuval and Gruener, 1977) have detected raised levels of methemoglobin in bottle-

fed infants whose water supply contained 45-55 milligrams per liter of NO_3 ; the usually accepted standard for NO_3 in drinking water is 45 milligrams per liter.

High nitrate intakes (from drinking water or food) have also been associated with adult cancer of the stomach and bladder in Chile, Columbia, England, and elsewhere.

These problems may be countered by surveillance of drinking water sources to identify the communities at risk. In any one country these communities will probably be small in number and restricted in geographical distribution. If the nitrate problem derives from discharges or seepages of sewage or night-soil it may be possible to prevent these occurrences. Nitrates may come from many other sources, however, particularly from agricultural runoff, and it could be more practical to provide the community with piped water of low nitrate content.

CHAPTER 13

THE HUMAN ELEMENT IN SANITATION SYSTEMS

13.1 INTRODUCTION

Discussion of alternative technologies for excreta disposal (chapters 9-12) and their possible impacts (chapter 5) has revealed some rather demanding stipulations about the social conditions under which maximum benefits can be achieved. Several health benefits can only be expected to occur if latrines are properly used and maintained. Changes in the public's knowledge and practices may be required before some systems are acceptable. Good maintenance of both the private and the public components of sanitation systems is vital. That there are many calls for health education or more effective program administration is a clear indication that in practice these social prerequisites of effective sanitation are seldom achieved. Yet the diagnosis of social ills has often taken a simple deductive form: if the technology fails the fault must lie with the users. Careful analysis of these social factors might reveal that sometimes the public's response could not reasonably have been otherwise.

A recurrent theme in this publication has been that excreta disposal systems must be suited to their environmental conditions (the climate, the endemic diseases, water availability, or civic wealth), many of which are clearly beyond the control of the authorities. It is too often assumed, however, that society is within their control and that it should change to incorporate the technology. The task is considerable. Several of the technologies that are appropriate to the urban or rural poor, because of their low capital cost, make heavy demands on the users (table 17). They may also place heavy demands on the limited resources of finance and trained manpower of public bodies that have responsibility for operation and maintenance.

It is reasonable to hope for some social change, but program designers should always ask themselves which changes are really practicable and, conversely, how far social, administrative, or political factors should be taken as constraints upon policy options. To do this one requires a good feel for the society and the way in which sanitation is handled within it. Two questions form the basis of our discussion; how do social values and understandings associated with health or defecation influence sanitation programs, and what scope is there for controlling excreta disposal through the activities of households, groups, or urban government? The questions are interrelated because understandings and values influence institutions while the consequences of institutional behaviour in turn influence individual understandings and values.

13.2 THE SIGNIFICANCE OF UNDERSTANDINGS AND VALUES

How people react to excreta disposal schemes or arrangements depends both upon deep-rooted cultural values and quite mundane matters of cost, convenience, or comfort. Either may have bearing upon what users prefer or accept and each should be checked in every project where the acceptability of the technology is in the least doubt. Resistance to new latrines might be due to inadequate door catches (a mundane factor)

or perhaps, for Muslims, inadvertant and inappropriate orientation towards Mecca (Goyder, 1978), which impinges upon deeper rooted values and conventions.

Cultural interpretations of excreta and of defecation underly peoples responses both to the deposition technologies and to removal and reuse processes. Usually excreta have a rather special status. In many societies excreta are only referred to in everyday speech with calculated disrespect for the values of society. Excrement is a thing apart, despised, taboo. How far this is the case varies; for some people it is simply dirty, but for others it is dangerous, a matter for personal defilement or for evil uses, to be scrupulously avoided or carefully disposed of (Curtis, 1978). There are many interpretations of the significance of excreta besides that of modern science, with its concern for the pathogens that excreta contains.

These varying interpretations will be reflected in the principles and practices of personal hygiene that are to be found in different parts of the world. Many hygienic practices have little to do with pathogen avoidance, for instance, doctoring one's house against witchcraft, and many substances will be regarded as dangerous, like finger nails or hair clippings, that are of little interest to modern science. Yet in most cases there is a large element of common ground between science and these other beliefs, if not in interpretation, then at least in practice. For instance, the ancient Israelites were instructed to take a stick with them to bury their feces on their early morning journeys from the camp to the bush--probably quite an effective sanitary prescription--but it is clear from the context that this instruction has more to do with the ritual cleanliness of warriors before battle than with disease transmission as such. (Deuteronomy, chapter 23: V.12).

Mary Douglas, seeking an explanation of the universal existence of taboos, suggests that those things become taboo that are difficult to classify culturally (Douglas, 1966). Pursuing this idea, it might be found that most societies like to maintain a clear distinction between man and animal; man is the thinker, tool user, made in the image of God and so on, while animals are instinctive, confined to their creature strengths, and of a lower order of existence. Yet this distinction is difficult to maintain, particularly in relation to bodily functions. Defecation is a taboo subject and excreta is a taboo substance because it reveals to man a side of his existence that he would prefer to forget. If this is a widespread cultural phenomenon, then it fits that man seeks privacy to defecate; defecation should be confined to the bush and excreta, are, if possible, avoided.

The question of interpretation aside, one has here a number of fairly widespread and deeply felt reactions to the problem of defecation, all of which can be utilized to promote practices conducive to improved hygiene in a scientific sense of the word. Privacy, apartness, and dirt avoidance are all values that lend themselves to the use of modern excreta disposal technologies, and beyond these there is a range of widely shared values--avoidance of odor, household cleansing, sweeping, clothes washing, and so on--that go to make up a fairly reliable common basis for domestic sanitation programs.

There are, of course, situations in which effective excreta disposal will not be achieved unless people come to have some new understandings of the health hazards in excreta and of the measures that can be taken to avoid them. There will be some situations in which traditional understanding and practice, such as defecating into rivers that are also water supplies, are strongly contraindicated by modern interpretations of health and disease. So authorities may have to play a didactic role, but they can nearly always do so by building upon traditional cultures rather than starting from scratch.

Regrettably, the widely shared cultural evaluations of excreta have an equally common side effect: people who, by their occupation, come into regular contact with excreta become themselves avoided. In many towns throughout the world, sweepers and night-soil removers are drawn from disadvantaged minority groups living in segregated communities within the towns whose occupation tends to reinforce their segregation. This constitutes a rather intractable problem where some kind of cartage system of night-soil removal is necessary.

13.3 THE SIGNIFICANCE OF SOCIAL STRUCTURE AND ORGANIZATION

Any excreta disposal system is a complex social activity involving planners, administrators, politicians, and corporation workers as well as the humble user. Officials, for their part, can plan improved systems but may face difficulties in raising the necessary resources, cooperating with other agencies, delivering the goods, and, crucially, building up routine services for maintenance. Additionally there are problems in securing political support for low-income schemes when upper-income groups, who can better afford to pay and have more political weight, are clamoring for services at a higher standard.

Politicians themselves face the full brunt of decisions about priorities in urban development and, where they have to recruit public support to keep themselves in office, they face pressures to employ more sweepers or to favor particular parts of the community with services.

Workers, such as the operatives of cartage systems, will have a number of preoccupations beyond service to the city. They must secure for themselves a living wage and tolerable working conditions, and in their struggles with the authorities or with a public unwilling to see their taxes increased, they will use what sanctions they have at their disposal, such as the disruption of services.

In short, whatever the high ideals about quality of human life embodied in sanitation programs, they cannot escape from being a part of the complex social system of the city and any attempt to make them work better has to take this system into account. The following sections examine these social values and social organizational issues in relation to the deposition, transportation, and reuse of excreta.

13.4 DEPOSITION

It is difficult to predict how people will respond to technical innovations because many factors enter into their choice. But much can be gained by putting oneself into the position of the user and looking at innovations from his point of view. For the user, the toilet itself is a most important element in the excreta disposal system. He may have to decide whether to invest in one, and he must daily face using it. Even people conscious of hygiene will take more than cleanliness into account in making these decisions, and disadvantages may not have to be very great before some people will opt out of whatever innovation is being proposed.

Cost

Most obvious and perhaps most cogent of all social constraints is the cost of latrines. The existing distribution of sanitary facilities is heavily skewed towards the rich (both nationally and internationally), not least because sanitation is expensive. Many of the alternative technologies discussed in this book are cheaper, and some very much cheaper, in capital terms than the sewerage systems of the industrial West, but most of the savings occur in the cost to the public authority, which is spared from the expense of sewers. The cost of the toilets themselves may still be very considerable and at some point down the scale of poverty it ceases to be reasonable to expect people to pay for their own installations. In many urban environments sanitation programs must be seen as an attempt to overcome one of the multifarious effects of poverty and, as such, they are bound to involve a degree of government intervention through subsidies. Where excreta have an economic value, some of the costs of disposal can be balanced against the expected income from reuse, but this is more likely to defray the costs of cartage than the in-house costs.

Convenience

The location of latrines is important and must itself be a balance of advantage. Sometimes the technology constrains the choice of location but, assuming that all options are open, toilets may be sited inside the house or compound or at some distance away, and people may also be sensitive about such matters as the prominence of the toilet to public view. Such factors have to be explored in detail in each situation, but some general principles may be postulated.

If the latrine is sited at some distance from the living quarters people may be discouraged from using it on dark nights or in inclement weather; if it is close to the house there may be a feeling that defecation is not adequately segregated from the rest of daily living. In a new tenement housing scheme in Madras, where toilets were provided in each flat, housing officials found that some of these were filled with sand and the space used for other purposes. A possible explanation of this response might be that defecation within these very small apartments, even behind closed doors, was unacceptable to the occupants (Curtis, 1978).

Outside toilets may be difficult to locate with sufficient privacy in urban environments. Draft plans for an urban site and service scheme in Africa made provision for latrines to be sited in the front corner of plots where they could be conveniently linked to sewer lines along the roads. But there were considerable doubts as to whether this technical convenience would be socially acceptable since the first thing to confront household visitors would be the toilet. A privy should be private. Most societies have conventions in these matters, for example, that the back of the house is private, the front is public, and these conventions need to be discovered and respected.

People may be sensitive not only about the location of the toilet but about the journey to the toilet. In Botswana it was found, through careful monitoring of a latrine program, that the act of carrying a container of water to the new privy (something that would be quite acceptable in India) was found to be an embarrassing announcement to the world at large of one's intentions. The design was subsequently modified to provide a water source at the latrine.

A major difficulty with toilets may be providing access to the right people at the right time. Householders may be inclined to keep outdoor latrines locked to prevent misuse by passersby, with the unfortunate consequence that they are not then available for children during the day. Similarly, in the tenement scheme in Madras, interior toilets were inaccessible to children while both parents were out seeking work during the day. Private toilets have to be carefully designed and located to secure both adequate access and adequate control. Counterbalancing these factors is the fact that most toilets provide a degree of privacy such that the time of day when defecation may conveniently take place is greatly extended from the dawn or dusk periods that are often favored by those with no facilities at all.

Comfort

Comfort has been found to be a great selling point for latrine programs, but again the social requirements are difficult to predict. There are the well-recognized cultural preferences for sitting or squatting (the latter in part an act of avoidance of physical contact with possibly defiling surfaces), and there are also strong commitments to particular anal cleansing procedures that must either be accommodated by the new technology or changed if necessary. Additionally there are the well-founded anxieties of children about cavernous holes in squatplates, and the surroundings must not be slippery to endanger the aged, or hot and smelly to discourage all users.

A vital aid to comfort has been the inclusion of personal washing facilities in the toilet schemes, as in the comfort station program in Ibadan (Adenwagun, 1975). Facilities for hand washing at the place of defecation are highly desirable in any case, but total body washing in privacy could also be much appreciated. In India for example, customary sanitary prescriptions require a bath to follow defecation (Kochar, 1978) and, in these circumstances, linked bathing and toilet facilities would be a great encouragement to the use of both private and public latrines.

Comfort has to do both with physical conditions and the fulfillment of conventional expectations. Householders in Botswana found the gap left at the bottom of their door for ventilation in their outside toilet to be disconcerting because people could see their feet. Conventional expectations may be numerous and the only way to discover them is to carefully monitor reactions to new designs in each situation.

In many rural areas latrine programs may face the problem that people find the bush more acceptable and more comfortable than pit latrines, or even some more sophisticated technologies. This choice may reflect both the fact that defecation is often regarded as a shameful activity that should properly be confined to the wilds (as Muhondwa, 1976, found in Tanzania) and also possibly the acknowledged tendency for many pit latrines to be hot, malodorous, and fly ridden. The first problem decreases when the bush becomes inaccessible, as in town, or is so diminished that it constitutes highly contaminated spinneys or copses in areas of intensive cultivation. At this point the population presumably becomes susceptible to new interpretations of what constitutes appropriate defecation environments. Latrines can be presented as answers to the problem of privacy and the analogy with the bush may be maintained by siting the construction at a suitable distance from the house. Crowded urban environments present opportunities for creating new conventions, practices, and concepts of comfort that program leaders should seize upon.

Group or Communal Toilets

Private, domestic latrines have so many advantages to the user over any arrangements where members of different households have to share their facility that they are always preferable where people can afford them or where there is space available for them. High costs and problems of land scarcity, however, may oblige authorities to go for group or communal facilities even though, from past experience, they are highly problematical. The problem in all cases is maintenance. Public toilets have a very poor record in this respect and are in any case inherently difficult to maintain. It only takes one misuser, perhaps a child avoiding the hazards of the hole, to establish a chain of subsequent misuse for which no one is willing to take immediate responsibility.

For public authorities there are two possible responses to this problem: constant attendance by a cleaner, or providing public toilets for identified or self-identified groups of households. The first is an expensive business requiring the provision to be on a large scale. In general such arrangements are common only in public places like market areas or main thoroughfares where provision must be made for large numbers of occasional users who are passersby. The additional expense of an attendant is often covered by a small charge to the users, which of course is not possible in toilets designed to serve the requirements of a resident population. Otherwise these toilets are serviced by a cleaner who may be responsible for a number of such facilities and who will be in a very poor position to prevent misuse or to tidy up after the event.

The potential for achieving better management of public toilets through associating them with an identifiable group of households is currently being explored in the Ibadan Comfort Station program in Nigeria where, in the old town, the indigenous social structure of family groups provides a framework for the social control of latrines. The facilities, designed to serve between 350 and 700 people, are built by the authorities with the people themselves providing the land from the family holdings and a contribution to the cost of construction. The group, under the leadership of the traditional family head, then either appoints a cleaner and pays him from a communal fund or allocates responsibility for cleansing and maintaining the separate toilets to each of the participating households. The pilot scheme was monitored by a health education team that identified several problems (Adenwagun, 1975). Cleaners were often badly in arrears in their pay, and where the people themselves undertake to carry out cleaning and maintenance, the constant attention of the health education team seemed to be necessary if standards were to be maintained. A basic problem appeared to be paying for water and electricity, and in some cases supplies were withdrawn. This raises questions about how best to divide tasks among the public authority and the local groups. Voluntary groups often have difficulties in collecting money from their members on a routine basis (Feachem *et al.*, 1978) because defaulters discourage those who would otherwise be inclined to pay regularly.

In most cases public facilities have to be provided either by public authorities or by these authorities in conjunction with the users. Where night soil has a commercial value, however, there may be potential for the commercial organization responsible for reuse to provide the toilets themselves. In Indonesia, fishpond owners, who stand to make a profit from the cultivation of fish, provide a number of latrines overhanging their ponds for the use of the neighborhood. Whatever the other virtues or vices of this system, the great advantage is that public authority management and maintenance is minimized as the fishpond owner has to maintain the facilities in a manner that is attractive to potential users. It is not clear, however, whether in other circumstances, as with cartage systems, it is possible to push contractors beyond servicing the latrines into providing the latrines.

13.5 REMOVAL SYSTEMS

Regrettably perhaps, a sewerage system is not only a technically efficient removal system, given massive financial outlays, but once constructed it is also the easiest to organize and run. The technology may in part be complex, but the need for massive servicing is removed. Instead of an army of sweepers, such as is required to empty buckets and push carts, a sewerage system may be run by white-coated technicians assisted by a few manual workers whose jobs are performed away from the public gaze, underground or beyond the urban bounds. The labor force required is small, elite, and dispensable for short periods. Breakdowns in sewerage systems usually cause environmental pollution at the treatment works rather than direct disruption to the public. In other words, as is the case with many modern technologies (Dickson, 1974), a sewerage system is more socially controllable than any of the less automatic technical alternatives.

By contrast, cartage, in its simplest bucket latrine form, requires large numbers of workers carrying out routine collection from households using buckets, boxes, or barrows that must be emptied into a cart of some sort for conveyance of night soil to a disposal point. Because the buckets have limited capacity, the system is prone to crises either from mismanagement or from collective action on the part of the workers. Civic authorities face on the one side, citizens with various means at their disposal for insisting upon a reasonable service, and, on the other, workers who wish to exercise what strength they have to get a reasonable reward for carrying out an unpleasant and socially degrading job. Which party gets the relative advantage depends upon the labor market, politicians' need for political support, and other factors, but in any case cartage systems are quite likely to present organizational and political problems for the civic authorities. If these authorities decide to change to sewerage systems this may reflect a desire to escape from organizational problems involved in cartage systems.

Direct handling of night soil in cartage systems leads to the situation in which it is often only groups of strangers or refugees or other disadvantaged sections of the urban community who are prepared to take the job. In the Indian subcontinent the work is associated with the Sweeper castes, whose untouchable status the Indian government has been endeavoring to overcome. In practice, however, where there is continuing association of these castes with occupations like night-soil removal this has proved to be very difficult, and removing a stigmatized occupation is a major additional incentive to changing the excreta disposal system. Even stigmatized occupations may be in strong demand, however, where alternative sources of employment are not available. Operators in parts of cities covered by private cartage systems may have to buy their right to service a street (Streefland, 1978), and municipalities are often under strong political pressure to expand the number of sweepers in their employ. For a sweeper there is perhaps only one thing worse than being of low social status in a lowly regarded occupation and that is being of low social status without any occupation at all. So, from a social as well as economic point of view, whether or not night-soil cartage systems are appropriate depends on the state of the wider economy. If there are equally well paid or better jobs available then it must be assumed that night-soil removers will opt for these and there will be a strong argument for changing the disposal system. If there are no other jobs available there will be strong pressure from the disadvantaged groups themselves to maintain the cartage systems.

If hand-operated cartage systems remain necessary, something can be done to improve the social position of the operatives by improving the terms and conditions of service. Very often low status is reinforced by low pay that, if improved, would go some way to counteract low status. It may, however, be difficult to radically alter the pay structure while there remains a reserve army of unemployed sweepers, without simply encouraging subcontracting. Also, government policy on public sector pay may limit the options and create problems of its own. In some cases minimum wage legislation may set the scale for manual labor in the public sector above market rates, causing labor intensive technologies to be uneconomic while there are still men willing to do the work. On the other hand, as in Port Sudan (Spencer, 1978), set rates of pay that are not competitive with

private sector employment make it difficult to build up and train adequate staff. Even if it is difficult to make major changes in pay, however, working conditions can be improved in other ways. Where working clothes are issued, they are often not dissimilar in appearance to those of convicts, serving to set the users socially apart more than to protect their bodies. Equipment is also poorly designed and badly maintained, and facilities for washing and changing after work are inadequate or neglected altogether. Improvement in any of these dimensions will improve the social status of night-soil removers.

Operatives of vacuum trucks have a stronger bargaining position because they are more skilled and, in any one town, fewer in number. Sealed vaults, having no treatment potential and being of limited capacity, also have a crisis point if they are not emptied in time and organized labor can use this to their advantage. Septic tanks, on the other hand, are less crisis-prone and might for this reason be favored by authorities that are worried about the organized power of their labour force.

Improved technologies, requiring less direct handling of feces, may facilitate an improvement in the status of night-soil removers, particularly since more skilled jobs will attract higher pay, enabling the workers to maintain an improved standard of living. If the social stigma attached to night-soil removal really is lifted by improved technology, however, this would open the job to people outside the minority who have traditionally held this occupation so that they would lose their monopoly.

Since many towns will in the future require improved cartage systems of one kind or another, it is important to discover whether the social stigma attached to night-soil removal can under any circumstances be removed. Evidence is hard to come by. Some reports from China (Streefland, 1978) indicate that, because of the importance attached to health in that society, the status of night-soil removers has improved since the revolution. In a society where reuse of excreta has always been practiced, however, it is quite unlikely that the job ever carried the stigma that it does, for instance, in India, where the rituals of excreta avoidance are highly developed. Furthermore, the involvement of the public in hygiene and sanitation improvement committees, as in China, will not necessarily elsewhere lead to an improvement in the status of those people who are employed in night-soil removal. This remains an important area for future investigation.

In many societies where night soil is valued as a fertilizer, cartage is a private sector activity. Cartage contractors make their money from selling the material to farmers, by being paid for the job of removal itself, or from a combination of both. In some towns, different areas are serviced by small-scale contractors who form agreements with individual householders for night-soil removal. In others, larger scale operatives undertake contracts with city corporations. Some operate simple cartage systems; others, as in Kano, may service septic tanks with vacuum trucks. Private contractors may be difficult to control, particularly where they are numerous and stand to gain from dumping their loads in the nearest water course rather than removing them from the city to agreed disposal points. A good price for the product, however, is a big incentive to efficient night-soil removal.

13.6 REUSE

It is now widely accepted in the expert circles that reuse of wastes is a desirable objective if it can be hygienically achieved. This conclusion brings exports into line with the large part of mankind that has always favored reuse. In these parts of the world the problem is perhaps how to persuade people that additional stages of treatment are sufficiently important for health reasons to warrant the increased time and expense that treatment requires. Elsewhere, however, the idea of reuse is not easily accepted culturally. Many people share the prejudice of Zola's villagers in the novel La Terre against the old lady whose beautiful vegetables were nurtured by night soil, relieving her poverty but putting her beyond the bounds of social acceptance. Deep seated though these prejudices may be, however, the situation is far from irredeemable. There are several reasons why the significance of cultural barriers to reuse is less than it might first appear to be. Processing can transform something that is socially unacceptable to something that is much more easily accepted. As sheep, those playful, woolly creatures become (in English usage) mutton when thin sliced and served with mint sauce, so excreta, despite their malodorous associations, can, when treated and moved to another environment, become compost or fertilizer. Part of the art of treatment must be the achievement of this cultural transformation to enable farmers to face a pleasant textured, acceptably smelling substance they can happily associate with the refurbishment of their land.

Unlike the true subsistence farmer who experiences the whole cycle of agriculture from production to consumption and back to production, a commercial farmer produces for a distant and impersonal market and is prepared to use any agricultural inputs that are conducive to a good return in the market. The urban consumer, for his part, can only judge food by its appearance in the market stall and knows little of its origins. The separation of producer and customer is both geographical and institutional. Its positive aspect is the diminished significance of individual preferences and prejudices upon the productive processes, but it has a negative aspect also, which is that the public has to be protected from unscrupulous or unhygienic practices by bureaucratically administered controls upon production and marketing processes. Thus fish grown in oxidation ponds managed by the city corporation under controlled conditions can escape any stigma because in the market place they cannot be easily identified or, as in India, produce grown in fields irrigated with sewage enters the market unnoticed, though in parts of that country reuse of night-soil is not a favored practice.

Lastly, in the West at least, and since the West is a great consumer of natural resources it is very important in this respect, prejudices against reuse are being counteracted by a new consciousness of a need to achieve ecologically sound farming practices and patterns of human existence. This takes the form both of an awareness of the undesirability of polluting rivers and seaboard with untreated or inadequately treated sewage and of the need to find substitutes for the energy consuming artificial fertilizers that are required in large volumes in agriculture. This transformation of values, coinciding as it does with the rather more structural changes

described above, has now proceeded to the point that constraints upon effective reuse are more concerned with questions of cost and technical feasibility (particularly the problem of the mixing of domestic wastes with industrial wastes in most urban sewerage systems) than questions of cultural predispositions. If there remain effective scruples about reuse, these are more likely to lie with policy makers than amongst the users themselves, and top managers are the people most exposed to the new ideologies about conservation and the need to manage resources effectively.

How effectively the reuse of urban wastes can be controlled depends upon its organization. On the urban periphery people may treat and reuse their own night soil in local fields or gardens, making it very difficult for local authorities to establish effective controls. Similarly, small-scale private contractors in night-soil removal who service a number of households and sell their product to farmers in the countryside may easily escape bureaucratically administered controls. If, on the other hand, the municipality itself administers night-soil removal or contracts it out to large-scale commercial enterprises, the authority is then in a position to enforce suitable treatment before the product is made available to farmers.

13.7 IMPROVING THE MANAGEMENT OF URBAN SANITATION SYSTEMS

The success of sanitation programs depends largely upon the capacity of municipal governments or other public authorities that must promote, control, and service the schemes. These authorities exercise their authority in enforcing routines and ensuring that the public plays its part. The need for administrative discipline extends not only to the supervision of routine operations, but also to the collection of dues and the control of access to services. Experience, past and present, indicates that in practice this management ability is often the main limiting factor in sanitation programs (Rybczynski, Polprasert, and McGarry, 1978). Not only are urban services often inadequate in extent--to be expected in rapidly growing cities--but also existing systems suffer from malpractices that add to their deficiency. Contractors dump night-soil indiscriminately in rivers or drains. Workers gain political protection when attempts are made to enforce work routines. Members of the public get their houses preferentially connected to water supplies or sewer lines by paying "speed-money" to minor officials. The poor pay their dues while the rich avoid payment.

These difficulties are unlikely to occur if the public at large is solidly behind the policies of their authorities and can effectively exercise some influence upon the course of events. It is noteworthy that in revolutionary China, where improved sanitation has high priority, urban public services are backed by voluntary committees sponsored by the ruling party that serve to keep the authorities on their toes, while at the same time mounting health improvement campaigns and other voluntary activities (Streefland, 1978). Elsewhere a major role for community development officials, health education teams, and civic leaders must be to generate public support and commitment to environmental improvement, not so much for the direct action that this can

achieve, as for the backing that this can provide for the authorities in carrying out their proposals. No civic administration can maintain the integrity of its programs for long without active public support and, insofar as the kinds of sanitation schemes that we envisage here require radical changes in the distribution and organization of services this will require radical changes in civic consciousness also.

Such changes are not always forthcoming. In this rather imperfect world, realistic plans may have to allow for existing interest, commitments, and endeavour to promote change in spite of weakness in urban government and administration. Two different responses are currently in evidence. The one is to create special purpose agencies beyond the influence of local interest groups to take responsibility for the development of one city (as in the case of the urban development authorities to be found in most Indian cities), to look after the interests of a particular class of citizen, or to provide for one kind of service on a regional basis. There is perhaps a general trend towards specialized water and sanitation authorities in many different parts of the world. The protagonists of these special purpose agencies believe that they will be more effective development bodies than the traditional civic authorities because they are more free to draw up rational plans and follow priorities. These bodies, however, often find themselves in a competitive position with other authorities with similar or overlapping responsibilities and still require constant political support to be effective.

The other approach is to rely upon technologies that require minimum municipal commitment and to ask the potential users to create and maintain latrines through "self-help." Pit latrines or on-site composting toilets require little municipal effort (Table 17) beyond grants or technical assistance through inducements, enforcement of bylaws if this is deemed necessary, and some long-term emptying arrangements.

Neither of these two approaches can really be regarded as a substitute for getting wholehearted commitment to improved hygiene and sanitation from politicians and citizens alike, based upon a broad understanding of potential health and welfare benefits. This section concludes with a discussion of the strengths and weaknesses of self-help schemes (which can be more than simple substitutes for municipal endeavor) and of health education in meeting these objectives.

13.8 THE ROLE OF SELF-HELP SCHEMES

The potential of self-help schemes lies in the willingness of individuals or groups, even amongst the poorest elements in society, to do things like laying pipes, digging pits, or improving their physical environment for themselves. Self-help schemes can take advantage of the spirit of self-reliance sometimes to be found in informal or squatter settlements, and may also work well where the ruling political party is active in urban management and can organize and control developments, as in Lusaka. Carefully planned self-help exercises can totally transform a town, as in the case of Port Sudan, where unplanned settlements have been rebuilt and provided with basic services through authorities and people working in

unison for a few days in each quarter of the town. Critical evaluations of self-help schemes, however, (Chambers, 1974; Feachem *et al.*, 1978; Holmquist, 1970; Lamb, 1974; Schaffer, 1969) reveal that "self-help" often gets out of hand and ends in frustration for all parties. The potential hazards of self-help schemes in the field of sanitation can be summarized as follows:

- (1) if participation is voluntary some households will not participate for one reason or another and, insofar as health benefits depend upon complete coverage of the population, this will frustrate the objectives of the program;
- (11) there is no guarantee that those people who are most in need will be those who are most willing to participate, but to encourage "self-help" the authorities will be obliged to help those who are prepared to help themselves. Thus self-help initiatives can curtail the authorities' ability to decide upon priorities;
- (111) self-help can become a movement, backed by politicians for whom it provides a following, through which government finds itself committed to providing a level of services that it lacks the financial or manpower resources to meet; and
- (iv) self-help programs have shown themselves to be much more effective at generating capital in the form of "one-off" projects like classrooms, clinics, or dams than in maintaining services once they have been established.

Some of these difficulties can be overcome if authorities take a more rigorous approach to the organization of self-help projects from their inception. For instance they may need to:

- (1) enact bylaws requiring all households to provide themselves with latrines;
- (11) stipulate what categories of households they are prepared to assist with grants or technical guidance, and only help those who help themselves within these categories;
- (111) ensure that the number of projects undertaken does not outrun the funds available by persuading political leaders of the dangers in overstimulating demand and by requiring local groups to register their intentions with the authorities before undertaking a project; and
- (iv) limit the scope of a scheme to a size that can be adequately serviced by the authority in the future.

We can conclude that "self-help" can best be used for clearly defined and limited operations, like urban cleanliness campaigns or the initial construction of public or private facilities, where the people's contribution reduces costs and generates enthusiasm. It can also be conveniently linked with the broader task of health education.

13.9 HEALTH EDUCATION

At the beginning of this chapter we stated that some values, attitudes, and understandings can be accommodated by sanitary engineers, others have to be confronted and changed. In rural areas no progress can be made in cholera elimination while people site privies over rivers that, downstream, are other people's water supply. Health education campaigns have to tackle specific issues of this kind, while at the same time creating a general awareness of the potentials of new technologies for improved living conditions. Health education is, however, often disappointing both in design and in results. First, there is a tendency to lecture the public about good hygiene, balanced diet, or birth control, repeating textbook prescriptions without considering how the ideas apply in the listeners' particular circumstances. This rather patronizing habit neglects the many strengths in existing knowledge and practice, but it is also ineffectual. It fails to reveal the user's viewpoint and the genuine problems that technical innovations pose for him. Health education has to be a dialogue between officials and users if full benefits are to be obtained. A good example of this two way communication is the health education program that accompanied the Ibadan Comfort Station pilot scheme (Adenwagun, 1975). In this case, not only were the positive values of the users explored, but practical problems in implementation and maintenance, like finding suitable sites and paying for water, were discovered. Without this kind of detailed feedback to the authorities of the users' perceptual and organizational problems, campaigns are almost bound to founder in disenchantment and disorder. Health education has a critical role, not only as the vocal cords of the sanitation authorities, but also as their eyes and ears.

GLOSSARY OF TECHNICAL TERMS^{1/}

- activated sludge A common method of biological sewage treatment. Settled sewage is led into an aeration tank where oxygen is supplied either by mechanical agitation or by diffused aeration. The bacteria that grow in this medium, together with other solids, are removed in a secondary sedimentation tank and recycled to the aeration tank inlet. This creates a high concentration of biologically active flocs in the aeration tank.
- aerobic Living or taking place in the presence of air or oxygen.
- anaerobic Living or taking place without (or with little) air or oxygen.
- Anopheline Belonging to the group of mosquitoes (technically, the tribe Anophelini) that includes the genus Anopheles to which the vectors of malaria belong.
- aquaprivy A sealed settling chamber located directly under the toilet receiving only excreta and very small volumes of flushing water. Retention times may be up to sixty days and effluent goes to a soakaway or to small diameter sewers.
- bacillus A rod-shaped bacterium.
- bacterium (Plural, bacteria.) Unicellular microorganisms with a simple nucleus; free-living and parasitic forms occur. Usually included in the plant kingdom. They maintain the major natural ecological cycles of nitrogen and carbon. Without bacteria, animal life would not be possible and plant life very limited. The use of the term Bacterium as a taxonomic expression has fallen into disuse. The genus Bacterium (Wilson and Miles, 1955) approximates the genera Escherichia and Klebsiella within the family Enterobacteriaceae. Thus, B. coli becomes E. coli and B. aerogenes becomes K. pneumoniae. Organisms previously designated Aerobacter aerogenes are now mainly identified as K. pneumoniae. The reservation should be made, however, that some organisms previously identified as either B. aerogenes or A. aerogenes may in fact be species of Enterobacter.

^{1/} Taken partly from Benenson (1975).

- Biogas** Gas consisting mainly of methane produced by anaerobic digestion of organic waste.
- Carrier** An infected person (or animal) who harbors a specific infectious agent in the absence of discernible clinical disease and serves as a potential source of infection for man. The carrier state may occur in an individual with an infection that is inapparent throughout its course (commonly known as healthy or asymptomatic carrier), or during the incubation period, convalescence, and post-convalescence of an individual with a clinically recognizable disease, (commonly known as incubatory carrier or convalescent carrier). In either circumstance the carrier state may be of short or long duration (temporary or transient carrier or chronic carrier).
- Cartage** Systems of night-soil removal involving vehicular or manual removal. For instance, bucket latrine emptying into carried containers, carts, or trucks and vault emptying by suction pumps into tankers.
- Cercaria** The larval stage of a trematode worm that emerges from the snail host. Often refers to the final larval stage of schistosome species, which leaves an aquatic snail and infects man through the skin.
- Cestodes** Tapeworms or flatworms of the order Cestoda.
- Chemoprophylaxis** The administration of a chemical, including antibiotics, to prevent the development of an infection or the progression of an infection to active manifest disease. Chemotherapy, on the other hand, refers to use of a chemical to cure a clinically recognizable disease or to limit its further progress.
- COD** The chemical oxygen demand, COD, is the mass of oxygen consumed when the organic matter present is oxidized by strong oxidizing agents in acid solution. It includes some substances (such as cellulose) that are not available to microorganisms, but excludes some (such as acetic acid) that are.
- Coliform** A group of bacteria. Some of them, the fecal coliforms, are normally found in human and animal feces. Technically a member of the family Enterobacteriaceae.

- Communicable disease An illness due to a specific infectious agent or its toxic products that arises through transmission of that agent or its products from a reservoir to a susceptible host, either directly, as from an infected person or animal, or indirectly, through an intermediate plant or animal host, vector, or the environment.
- Compost The humus-like product of the aerobic or anaerobic composting of either night soil or sludge; often mixed with organic material rich in carbon (such as refuse or sawdust) prior to digestion.
- Composting A process of oxidation and mineralization of organic wastes taking place under moist but not wet conditions (moisture content: 20-60 percent). The process can be aerobic or anaerobic and, when night-soil or sludge are being composted, refuse, sawdust or other carbon-rich materials are added to provide carbon and reduce the moisture content to the required level.
- Composting toilet A toilet into which excreta and carbon-rich material are added (vegetable wastes, straw, grass, sawdust, ash, and the like). Provided the moisture content remains in the range 20-60 percent and that the C/N ratio is approximately 25:1, composting will take place and an inoffensive humus is produced.
- Culicine Belonging to the group of mosquitoes (technically the tribe Culicini), which includes the genera Culex, Aedes, and Mansonia; they can transmit various worms and viruses, but not malaria.
- Desludging Removing accumulated sludge from septic tanks, aquaprivies, and so forth.
- Digestion A process of oxidation and mineralization of organic wastes taking place under water (as at the bottom of an aquaprivy or waste stabilization pond) or in a very wet condition (as when primary sludge or night soil, with a moisture content of 94-98 percent, are digested). The process is usually anaerobic but not always.

Effluent	The liquid outflow from a <u>sewage</u> treatment works, <u>septic tank</u> , or <u>aquaprivy</u> .
Endemic	The constant presence of a disease or infectious agent within a given geographic area; may also refer to the usual prevalence of a given disease within such an area.
Epidemic	The occurrence in a community or region of cases of an illness (or an outbreak) clearly in excess of normal expectancy and derived from a common or propagated source. The number of cases indicating presence of an epidemic will vary according to the infectious agent, size and type of population exposed, previous experience or lack of exposure to the disease, and time and place of occurrence.
Excreta	Feces and urine, normally of human origin unless otherwise stated.
Excreta disposal system	The series of processes and equipment used by a family or community between the act of excretion and the final disposal or reuse of the <u>excreta</u> .
Facultative pond	A waste stabilization pond that is <u>aerobic</u>
Fatality rate	Usually expressed as a percentage of the number of persons diagnosed as having a specified disease who die as a result of that illness. The term is frequently applied to a specific outbreak of acute disease in which all patients have been followed for an adequate period of time to include all attributable deaths.
Fecal indicator	Those <u>bacteria</u> that normally, and preferably exclusively, live in the intestinal tract of man and other warm-blooded animals without causing disease.
Groundwater	Water located beneath the ground surface in water-bearing strata known as aquifers.
Helminth	A worm; free-living and parasitic forms exist.
Host	A man or other living animal, including birds, arthropods and molluscs, that affords subsistence or lodgment to an infectious agent

under natural conditions. Some protozoa and helminths pass successive stages in alternate hosts of different species. Hosts in which the parasite attains maturity or passes its sexual stage are primary or definitive hosts; those in which the parasite is in a larval or a sexual state are secondary or intermediate hosts. A transport host is a carrier in which the organism remains alive but does not undergo development.

Imhoff tank

A two-story (rather than two compartment) septic tank. The upper (settling) chamber has a steeply sloping trough-shaped base that is provided with slots to permit the solids to pass into the lower (digestion) chamber.

Immune person

A person (or animal) that possesses specific protective antibodies or cellular immunity as a result of previous infection or immunization or is so conditioned by such previous specific experience as to respond adequately with production of antibodies sufficient to prevent clinical illness following exposure to the specific infectious agent of the disease. Immunity is relative; an ordinarily effective protection may be overwhelmed by an excessive dose of the infectious agent or via an unusual portal of entry; may also be impaired by immuno-suppressive drug therapy or concurrent disease.

Inapparent infection

The presence of infection in a host without occurrence of recognizable clinical signs or symptoms. Inapparent infections are only identifiable by laboratory means. Synonym: Subclinical infection.

Incidence rate

A quotient (rate) arrived at by using the number of cases of a specified disease diagnosed or reported during a defined period of time as the numerator and the number of persons in the population in which they occurred as the denominator. This is usually expressed as cases per 1,000 or 100,000 per annum. This rate may be expressed as age- or sex-specific or as specific for any other population characteristic or subdivision.

Larva

A stage in the development of some organisms, including helminths and insects, differing from the embryo in that it can secure its own nourishment.

Latency	The term is used here to describe the length of time between the excretion of a <u>pathogen</u> and its becoming potentially infective to a new vertebrate <u>host</u> . The concept applies only to <u>helminths</u> because all excreted <u>viruses</u> , <u>bacteria</u> , and <u>protozoa</u> have zero latency.
Maturation ponds	The final ponds in a series of waste stabilization ponds. They are entirely <u>aerobic</u> .
Metacercaria	(Plural, metacercariae.) The fifth and final larval (or juvenile) stage of trematode <u>helminths</u> . It may occur as a transient stage in the vertebrate <u>host</u> immediately after infection by the <u>cercaria</u> , as in the schistosomes; more commonly it encysts on a plant or animal and infects its definitive host by ingestion.
Miracidia	The embryos of <u>trematodes</u> . Often refers to schistosome embryos that invade the bodies of snails.
Nematodes	Thread worm, roundworms or other similar worms of the class <u>Nematoda</u> .
Night soil	An accumulation of feces and urine collected without dilution by large volumes of water. Night soil is generally " <u>carted</u> " and will not flow by gravity in pipes.
Ovum	An egg (plural:ova).
Parasite	An organism that lives on or in another living organism, termed the <u>host</u> , and draws nourishment therefrom.
Pathogen	A pathogen or pathogenic organism in an organism that causes disease. Most pathogens are microscopic in size.
Persistence	The term is used here to describe the period between the excretion of a <u>pathogen</u> and its eventual death or inactivation in the environment. In the case of <u>helminthic</u> pathogens with one or more <u>intermediate host</u> , persistence describes the survival time of the final infective stage.
Pit latrine	The simplest latrine in which <u>excreta</u> fall into a hole in the ground. When the pit is about 2/3 full, it is usually filled in and a new pit is dug.

- Pretreatment** On entering a conventional treatment works, sewage is normally pretreated by screening or comminution (to remove or disintegrate large solids) and grit removal.
- Prevalence rate** A quotient (rate) derived by using the number of persons sick or portraying a certain condition (in a stated population, at a particular time, regardless of when that illness or condition began) as the numerator and the number of persons in the population in which they occurred as the denominator. For example, the prevalence rate of ringworm of the foot in a class of boys when examined on a certain day could be 25 per 100. Or, the prevalence rate of a positive serological test in a survey during which blood samples were collected from a population could be 10 per 1,000.
- Protozoon** (Plural, protozoa.) Unicellular animals that contain at least one well-defined nucleus and exhibit marked differentiation of function within a single cell. Free-living and parasitic forms exist.
- Reservoir of infectious agents** Any human beings, animals, arthropods, plants, soil, or inanimate matter in which an infectious agent normally lives and multiplies and on which it depends primarily for survival and reproduces itself in such a manner that it can be transmitted to a susceptible host.
- Resistance** The sum total of body mechanisms that interpose barriers to the progress of invasion or multiplication of infectious agents or to damage by their toxic products.
- a. **Immunity.** That resistance usually associated with possession of antibodies having a specific action on the microorganism concerned with a particular infectious disease or on its toxin. Passive immunity is attained either naturally, by maternal transfer, or artificially, by inoculation of specific protective antibodies (convalescent or hyperimmune serum) or immune serum (gamma) globulin (human); it is of brief duration (days to months). Active immunity is attained either naturally, by infection with or without clinical manifestations, or artificially, by inoculation

of fractions or products of the infectious agent or of the agent itself in a killed, modified, or variant form. It lasts months to years. Active immunity depends on cellular immunity, which is conferred by T-lymphocyte sensitization, and humoral immunity, which is based on B-lymphocyte response.

- b. Inherent resistance. An ability to resist disease independent of antibodies or of specifically developed tissue response; it commonly resides in anatomic or physiologic characteristics of the host and may be genetic or acquired, permanent or temporary.

Synonym: Nonspecific immunity.

ROEC

A Reed Odorless Earth Closet is a displaced pit latrine in which the excreta enter the pit via a chute. The pit is usually ventilated.

Scum

Solid material floating on the surface of a septic tank, pond, or the like. Scum often forms large floating masses, called scum mats.

Sedimentation

In this report, sedimentation describes the process by which the suspended solids in sewage are allowed to settle out under gravitational forces. Primary sedimentation refers to sedimentation taking place on a raw sewage, whereas secondary sedimentation takes place following biological treatment (usually by trickling filters or activated sludge).

Septic tank

A sealed settling chamber receiving all sewage and sullage from a dwelling and typically located buried in the garden. Liquid retention times are in the order of one to three days, and effluent normally drains to a soakaway.

Sewage

Human excreta diluted by water. It often contains other domestic wastewater (see

sullage) and may also contain industrial wastewaters. It generally flows in pipes, called sewers, and may flow to a sewage treatment works.

Sewage treatment works

A facility for improving the quality of sewage usually by removing solids (to form a sludge) and by allowing organic matter to be oxidized (usually biologically). All sewage treatment facilities produce a liquid effluent and a solid product called a sludge. Both effluent and sludge may be disposed of or reused.

Sewerage

A network of sewers, possibly with associated pumping stations and treatment facilities.

Sludge

The solid matter (often having a high water content) that is formed when sewage is allowed to stand so that the denser solids settle out, or that is a product of various treatment processes.

Soakaway

A pit or trench filled with stones or given a porous lining that allows effluents to drain into the surrounding soil and disperse underground.

Source of infection

The person, animal, object, or substance from which an infectious agent passes immediately to a host. Source of infection should be clearly distinguished from source of contamination (such as overflow of a septic tank contaminating a water supply or an infected cook contaminating a salad).

Sullage

Domestic wastewater not containing excreta, for instance, bath water and laundry water. Sullage is also called graywater. If a house is connected to a sewerage system, sullage will normally form part of the sewage. If, however, a house has a night-soil cartage system or uses a communal or on site latrine, sullage will have to be disposed of separately.

Susceptible

A person or animal presumably not possessing sufficient resistance against a particular pathogenic agent to prevent contracting an infection if or when exposed to the agent.

Trematodes

A class of worms including the parasitic worms called flukes.

- Trickling filter** A common method of biological sewage treatment, also known as a biofilter, percolating filter, biological filter, or bacteria bed. A circular or rectangular bed of coarse aggregate usually 1.8 meters deep. Settled sewage is distributed over the bed (often by rotating perforated pipes) and trickles down over the surface of the aggregate where a rich microbial film develops.
- Vector** Animal-- often an insect--transmitting an infection from person to person or from infected animals to person.
- Vented pit latrine** A pit latrine provided with a ventilation pipe connected to the top of the pit. A down draft is created through the squatting slab, ensuring an odor-free latrine cabin.
- Virus** An exceedingly small parasitic organism, capable of passing through filters that can retain bacteria. Viruses can only reproduce inside the animal or plant cells that they parasitize, but some of them can survive for long periods in an extracellular environment.
- Water table** The level or depth at which groundwater is encountered when a hole is dug or drilled.
- Worm load** The number of parasitic worms (helminths) with which a person is infected.
- Zoonosis** An infection or an infectious disease transmissible under natural conditions from vertebrate animals to man. May be enzootic or epizootic (which have meanings analogous to "endemic" and "epidemic", respectively).

APPENDIX II

UNCRITICAL SUMMARY OF SOME LITERATURE ON THE IMPACT OF IMPROVED EXCRETA DISPOSAL

Country	Type of study	Result	Source																				
Iran	Impact of mass treatment, sanitation, and sanitation with mass treatment on soil-transmitted helminths in fifteen villages in southwest Iran. Sanitation was one pit latrine per family and a communal water supply.	Mass treatment was highly effective in reducing both the prevalence and intensity of <i>Ancylostoma</i> and <i>Ascaris</i> . Sanitation added to mass treatment contributed nothing. Sanitation alone had an impact upon the intensity of both hookworm and roundworm and had a little impact on the prevalence of roundworm only.	Arfaa, <i>et al.</i> , (1977)																				
Philippines	A region with endemic cholera was divided into 4 areas: Area A: control area having poor water and sanitation facilities. Area B: improved water supply. Area C: pour-flush pit latrines Area D: improved water supply and communal latrines (with septic tanks)	The percentage effectiveness of these measures in reducing the incidence of cholera was: Area B: 73 percent Area C: 68 percent Area D: 76 percent	Azurin and Alvero (1974)																				
Brazil	In Pontezinha, Pernambuco, a village of 1,041 inhabitants, a socioeconomic and schistosomiasis survey in 1961 was followed by introduction of schistosome control measures, particularly environmental hygiene. In 1964 each house was provided with a simple latrine. The village had a central laundry facility with drinking water taps, showers and latrines, and nine dug wells with hand pumps were installed throughout the village. Prior to this a small outpatient clinic and a health education program were established in the village. Fecal surveys were carried out in 1961, 1966, 1967, and 1968. Costs of control measures were determined. Other villages without these interventions were surveyed in 1963 and 1969.	The percentage <i>S. mansoni</i> prevalence by Hoffman sedimentation fell: <table border="1"> <thead> <tr> <th>Prevalence percent</th> <th>1961</th> <th>1966</th> <th>1967</th> <th>1968</th> </tr> </thead> <tbody> <tr> <td>0 - 4 yrs</td> <td>6.8</td> <td>2.4</td> <td>0.0</td> <td>0.0</td> </tr> <tr> <td>5 - 9 yrs</td> <td>27.0</td> <td>6.4</td> <td>4.2</td> <td>4.3</td> </tr> <tr> <td>10 - 14 yrs</td> <td>56.0</td> <td>28.4</td> <td>12.1</td> <td>9.4</td> </tr> </tbody> </table> <p>By 1967 and 1968 no children aged 0-4 years became infected. Domestic and feral rodents were trapped annually. The prevalence in <i>Oryzomys</i> fell from about 20 percent to zero in some years. In two of the three control villages human prevalence also fell, but less dramatically than at Pontezinha. Snail infection rates of <i>Biomphalaria glabrata</i> fell from 6.9 percent to 0.1 percent. The cost of the measures used in control was U.S.\$0.98 per month per protected person over seven years.</p>	Prevalence percent	1961	1966	1967	1968	0 - 4 yrs	6.8	2.4	0.0	0.0	5 - 9 yrs	27.0	6.4	4.2	4.3	10 - 14 yrs	56.0	28.4	12.1	9.4	Barbosa, Pinto, and Souza (1971)
Prevalence percent	1961	1966	1967	1968																			
0 - 4 yrs	6.8	2.4	0.0	0.0																			
5 - 9 yrs	27.0	6.4	4.2	4.3																			
10 - 14 yrs	56.0	28.4	12.1	9.4																			

Country	Type of study	Result	Source
U.S.A.	Four hundred patients at a veterans hospital in Georgia had stool examinations for intestinal protozoa and helminths. They also completed questionnaires on their military service and living conditions.	The overall prevalence of infection with <u>Entamoeba histolytica</u> was 9.3 percent. Among those <u>not infected</u> , 22 percent had outside toilets, while amongst those infected, 55 percent had outside toilets ($p < .01$). Income was not significantly associated with <u>histolytica</u> infection.	Brooke, Donaldson, and Brown (1954)
U.S.A.	A survey of 357 people in four areas near Little Rock, Arkansas was carried out in 1961. Stools were examined for intestinal protozoa.	The overall prevalence of infection with one or more protozoa (APR) was 33 percent. Among all individuals served with piped indoor water supply the APR was 31 percent, while among those using well water it was 35 percent (no significant difference). Among 0-4 year old piped water users the APR was 13 percent, however, while among 0-4 year old well water users it was 37 percent ($p < .05$). Many of the houses with piped water also had sewerage, while well water houses had septic tanks or outside pit latrines.	Brooke et al. (1963)
Egypt	Comparative surveys were made in 1952 of helminthic and protozoan infections in two neighboring villages A and B. Village A had been previously surveyed in 1950. Village A had improved water supply from unpolluted wells, a bore-hole latrine in 90 percent of houses, a refuse collection service, and visiting nurses. Village B was untouched.	The improvements in village A had no impact on the prevalence of protozoal infections or on the mean number of infections per person. The author claims (unconvincingly), however, that the improvement caused "a definite lowering of exposure to <u>Ascaris</u> infection" which showed itself in a reduced prevalence and intensity. A similar claim is made for hookworm reduction.	Chandler (1953 and 1954)

Country	Type of study	Result	Source															
Panama	A series of egg counts were made in two villages, one partially sanitized and the other entirely without latrines. Egg counts were made before and after mass chemotherapy.	Reinfection after mass treatment was rapid but reinfection with hookworm was delayed in those groups with more and better maintained latrines.	Cort, Shapiro, and Stoll (1929) see also Sweet <u>et al.</u> (1929)															
U.S.A.	2,657 people living in a rural area of West Tennessee were surveyed for intestinal parasites. 90 percent were black. Details of family size, cleanliness, housing, water supply, and excreta disposal were also collected.	<p>Individuals having flush toilets or sanitary pit latrines had a lower prevalence of parasites than those with unsanitary latrines or no latrines. For instance:</p> <table border="1"> <thead> <tr> <th rowspan="2">Facility</th> <th colspan="2">Percent infected</th> </tr> <tr> <th>Entamoeba histolytica</th> <th>Ascaris</th> </tr> </thead> <tbody> <tr> <td>Flush toilet or sanitary latrines</td> <td>19</td> <td>8</td> </tr> <tr> <td>Unsanitary latrine</td> <td>36</td> <td>11</td> </tr> <tr> <td>No latrine</td> <td>29</td> <td>15</td> </tr> </tbody> </table> <p>Parasite prevalence was also found to be associated with family size, fecal contamination of the premises and cleanliness of house and person but not with water pollution.</p>	Facility	Percent infected		Entamoeba histolytica	Ascaris	Flush toilet or sanitary latrines	19	8	Unsanitary latrine	36	11	No latrine	29	15	Eyles, Jones, and Smith (1953)	
Facility	Percent infected																	
	Entamoeba histolytica	Ascaris																
Flush toilet or sanitary latrines	19	8																
Unsanitary latrine	36	11																
No latrine	29	15																
Guatemala	Extensive research into diarrheal disease (especially amongst children) was carried out in rural Guatemala during 1956-1963. Amongst many detailed studies and surveys, acute diarrheal rates among families having a latrine were compared with rates amongst those with no latrine. The latrines were not built for the study but were part of the government program and had been constructed several years previously.	<p>The case rates of acute diarrheal disease per 100 persons per year were as follows:</p> <table border="1"> <thead> <tr> <th>Age</th> <th>With latrine</th> <th>Without latrine</th> </tr> </thead> <tbody> <tr> <td>< 1</td> <td>80.7</td> <td>52.8 (not significant)</td> </tr> <tr> <td>1-5</td> <td>60.3</td> <td>80.3 (p < 0.05)</td> </tr> <tr> <td>6-14</td> <td>8.3</td> <td>11.7</td> </tr> <tr> <td>15+</td> <td>4.6</td> <td>7.3</td> </tr> </tbody> </table> <p>The authors conclude that "the data give no indication that privies as used in the villages had any influence on the diarrheas of children in the first two years of life, the important part of the problem."</p>	Age	With latrine	Without latrine	< 1	80.7	52.8 (not significant)	1-5	60.3	80.3 (p < 0.05)	6-14	8.3	11.7	15+	4.6	7.3	Gordon <u>et al.</u> (1964)
Age	With latrine	Without latrine																
< 1	80.7	52.8 (not significant)																
1-5	60.3	80.3 (p < 0.05)																
6-14	8.3	11.7																
15+	4.6	7.3																
U.S.A.	A survey of shigellosis among children under ten years in farm labor camps in California was conducted.	<p>The prevalences of <u>Shigella</u> excretion were as follows:</p> <p>In cabins with inside water faucets, shower and toilet -1.6 percent</p> <p>In cabins with inside water faucets but with all other facilities communal -3.0 percent</p>	Hollister <u>et al.</u> (1955)															

Country	Type of study	Result	Source
U.S.A. (continued)		<p>In cabins with no internal facilities - 5.8 percent</p> <p>When individuals were compared on the basis of inside or outside water (with other facilities the same), the prevalence of shigellosis was only 1.2 percent in houses with internal water, while it was 5.9 percent in houses without.</p>	Hollister <i>et al.</i> (1955) (continued)
U.S.A.	<p>White females (ages 18-76 years) at a mental institution in California were studied during 1954-57. They were originally housed in an old building in which standards of sanitation were poor. They were then rehoused in a new, modern hospital building with excellent sanitary facilities. Stool examinations were made on 110 patients prior to rehousing and on eight subsequent occasions.</p>	<p>The percentage of people infected with <u>Entamoeba histolytica</u> and <u>Giardia lamblia</u> rose steadily during the survey, indicating that transmission was continuing throughout the period. Although the percentage of people infected with hookworm (73 percent) and <u>Trichuris</u> (83 percent) remained constant, as would be expected in the absence of mass chemotherapy, no new case of hookworm and only three new cases of <u>Trichuris</u> were reported while the patients were in the new building. Thus, the move to the new building interrupted the transmission of the helminths but not the protozoa.</p>	Jeffrey (1960)
Japan	<p>A program of heat treating (with firewood) of night soil (up to 60°C) prior to agricultural application was implemented in a village in Shiga Prefecture. A control village was left untouched.</p>	<p>In the English summary, it is claimed that the prevalence of hookworm and <u>Ascaris</u> declined "strikingly" in the intervention village and that there was a marked decrease in the count of <u>Ascaris</u> ova found in the soil. These changes were not observed in the control village.</p>	Katayama (1955)
Japan	<p>Heat treating of night soil (with surplus night electricity) was implemented in a village near Osaka city.</p>	<p>Night soil treatment alone had only a slight effect on the prevalence of parasite infections. When mass chemotherapy was carried out, prevalences fell markedly (hookworm from 52 percent to 11 percent, <u>Ascaris</u> from 33 percent to 12 percent) and remained at this low level throughout the five-month observation period.</p>	Kawagoe <i>et al.</i> (1958)
Egypt	<p>A bucket latrine system was introduced into Tula Prison. Prisoners worked in quarries and were provided with treated Nile water for drinking and ablution. The local population used untreated Nile water and had no latrines. The parasite infections of the local population were compared with those of the prisoners after various periods of incarceration.</p>	<p>Schistosomiasis and hookworm prevalence in the local population were approximately 75 percent and 70-88 percent respectively. Among prisoners, the rates fell from 30 percent and 68 percent respectively to less than 20 percent in both cases after five years of incarceration and to about 10 percent after twelve years. Reinfection with <u>Ascaris</u> occurred regularly due to contamination of sewage-irrigated vegetables.</p>	Khalil (1931)

Country	Type of study	Result	Source															
Singapore	One hundred fifty nine families living in modern flats and 169 families living in squatter housing were studied. The flats had two to four rooms, flushing toilets, water connections, and refuse disposal chutes. Squatter housing had shared bucket latrines, communal standpipes, and inadequate refuse disposal. The people in the flats had previously lived in the squatter housing but had been rehoused following a fire in 1961. Average family income of flat dwellers was Mal. \$165/month while for squatters it was Mal. \$130/month. Stool samples were collected from all children under thirteen years in the selected households.	Helminthic prevalence rates were as follows: <table border="1"> <thead> <tr> <th rowspan="2">House type</th> <th colspan="3">Percent infected</th> </tr> <tr> <th><u>Ascaris</u></th> <th><u>Trichuris</u></th> <th><u>Hookworm</u></th> </tr> </thead> <tbody> <tr> <td>Flat-dwellers</td> <td>9</td> <td>28</td> <td>1</td> </tr> <tr> <td>Squatters</td> <td>63</td> <td>58</td> <td>2</td> </tr> </tbody> </table> <p>Among those infected, no very striking differences in worm burdens between flat-dwellers and squatters were observed. The difference between <u>Ascaris</u> and <u>Trichuris</u> prevalence amongst the flat-dwellers is explained by the longer life span of <u>Trichuris</u>.</p>	House type	Percent infected			<u>Ascaris</u>	<u>Trichuris</u>	<u>Hookworm</u>	Flat-dwellers	9	28	1	Squatters	63	58	2	Kleevens (1966)
House type	Percent infected																	
	<u>Ascaris</u>	<u>Trichuris</u>	<u>Hookworm</u>															
Flat-dwellers	9	28	1															
Squatters	63	58	2															
Panama	Children presenting at a clinic in Panama City were examined for excretion of enteropathogenic <u>E. coli</u> , <u>Shigella</u> , and <u>Salmonella</u> . These data are related to information about type of housing and sanitary facilities.	Bacterial pathogens were completely absent from children coming from the best housing type while for all other housing types about 8 percent of children had one or more pathogens. No attempt is made to relate this finding to specific environmental or sanitary factors. The sampling method permits major bias in the results, which the authors do not discuss.	Koussou and Munoz (1969)															
India	The impact of a bored-hole pit latrine and health education program on the incidence of diarrhea in children in the village of Bharwara, near Lucknow, was investigated.	The authors claim that the intervention was related to "a declining trend in diarrheal morbidity." The methodology, however, appears weak, the data presentation is obscure, and the study, as reported, is of little value.	Kumar, Sehgal, and Singh (1970)															
Japan	Night-soil treatment with thiabendazole was implemented in a village of 5,000 people near Tokyo. Three areas were distinguished: Area A: night-soil treatment + chemotherapy Area B: night-soil treatment only Area C: chemotherapy only. Parasite prevalence was surveyed between July 1964 and March 1966	The proportion of people excreting <u>Ascaris</u> ova fell by 50 percent in Area A, by 30 percent in Area B and hardly at all in Area C. From these and other data it was concluded that the application of thiabendazole had a substantial impact upon human ascariasis. (Similar studies were conducted on the impact on <u>Trichuris</u> and hookworm infections. The rate of new infections with <u>Trichuris</u> was one third, and that of hookworm was one half, in the treated area compared with the control area).	Kutsumi (1969)															

Country	Type of study	Result	Source																
U.S.A.	In 1952 a program of borehole latrines was implemented in Boston, Georgia. The prevalence of <i>Shigella</i> excretion, in Boston and control towns, was surveyed in children under ten years.	The latrine program was associated with a reduction in the detection of <i>Shigella</i> from rectal swabs from 4.7 percent to 2.8 percent. Rates in control towns did not fall over this period. After completion of the latrine program, the reported diarrhea rate was half that in the control towns. Although the house fly population in the community was not reduced by the latrine program, the breeding of flies in latrines, in contact with excreta, was much reduced.	McCabe and Haines (1957)																
U.S.A.	Excretion of <i>Entamoeba histolytica</i> among 1,115 urban school children in North Carolina was studied. These data were related to excreta disposal, water supply, and garbage disposal facilities in the homes of the children.	The following prevalences were ascertained:	Mackie <i>et al.</i> (1956)																
		<table border="1"> <thead> <tr> <th data-bbox="764 534 847 555">Facility</th> <th data-bbox="968 512 1257 555">Infection of school children with <i>Entamoeba histolytica</i></th> </tr> </thead> <tbody> <tr> <td data-bbox="756 576 946 597">Inside flush toilet</td> <td data-bbox="1017 576 1202 597">6 percent (42/736)</td> </tr> <tr> <td data-bbox="756 619 946 661">Shared flush toilet (inside)</td> <td data-bbox="1009 640 1194 661">12 percent (10/87)</td> </tr> <tr> <td data-bbox="756 683 897 725">Shared flush toilet (yard)</td> <td data-bbox="1009 704 1194 725">12 percent (11/95)</td> </tr> <tr> <td data-bbox="756 746 946 768">Private pit latrine</td> <td data-bbox="1009 746 1177 768">58 percent (7/12)</td> </tr> <tr> <td data-bbox="756 789 938 810">Shared pit latrine</td> <td data-bbox="1017 789 1169 810">0 percent (0/3)</td> </tr> <tr> <td data-bbox="748 821 827 842"><u>Unknown</u></td> <td data-bbox="1017 821 1191 842"><u>3 percent (5/182)</u></td> </tr> <tr> <td data-bbox="748 842 806 863"><u>Total</u></td> <td data-bbox="1017 842 1219 863"><u>7 percent (75/1,115)</u></td> </tr> </tbody> </table>	Facility	Infection of school children with <i>Entamoeba histolytica</i>	Inside flush toilet	6 percent (42/736)	Shared flush toilet (inside)	12 percent (10/87)	Shared flush toilet (yard)	12 percent (11/95)	Private pit latrine	58 percent (7/12)	Shared pit latrine	0 percent (0/3)	<u>Unknown</u>	<u>3 percent (5/182)</u>	<u>Total</u>	<u>7 percent (75/1,115)</u>	
Facility	Infection of school children with <i>Entamoeba histolytica</i>																		
Inside flush toilet	6 percent (42/736)																		
Shared flush toilet (inside)	12 percent (10/87)																		
Shared flush toilet (yard)	12 percent (11/95)																		
Private pit latrine	58 percent (7/12)																		
Shared pit latrine	0 percent (0/3)																		
<u>Unknown</u>	<u>3 percent (5/182)</u>																		
<u>Total</u>	<u>7 percent (75/1,115)</u>																		
		Infection with <i>Entamoeba histolytica</i> was also associated with type of water supply and garbage disposal facilities. The interrelations between these independent variables, and between them and income, are not explored.																	
India	A single stool examination of 13,267 hospital patients and their contacts was carried out at Karnal, Haryana State. A sanitary inspector was sent to the homes of the patients to collect information on hygiene and domestic facilities.	The prevalence of <i>Ent. histolytica</i> excretion amongst those living in homes with no latrines (38.3 percent) was a little higher than for those using latrines (31.6 percent) ($p < .01$). The authors point out that this difference cannot necessarily be attributed to the latrines. The sampling method may expose the results to serious bias, which the authors do not discuss.	Mathur and Kaur (1972)																

Country	Type of study	Result	Source
Costa Rica	A survey was made of the sanitary characteristics of 1,202 houses in Costa Rica. Diarrheal morbidity and intestinal bacterial and parasites were surveyed, as was the quality of water, meat, and milk and the fly population. Three types of excreta disposal facility were distinguished: none (12 percent of houses), pit latrine (76% of houses) and flush toilets with septic tanks (12 percent of houses).	<u>Ascaris</u> prevalence decreased as the type of excreta disposal improved. <u>Trichuris</u> prevalence was the same amongst individuals with or without a latrine but was lower amongst individuals having a septic tank. <u>Shigella</u> organisms were not recovered where a septic tank was present. Diarrhea morbidity was <u>least</u> amongst those living in houses with no latrine. Excreta disposal facility was not associated with protozoal prevalence. Much more data are presented in this comprehensive and complex study. The independent variables are highly associated with each other and with rental values (and, presumably, incomes). Interpretation of the data is therefore extremely problematical.	Moore, de la Cruz, and Vargas-Hendez (1965)
USA	Parasite surveys were conducted in Virginia.	The authors conclude in part: "The introduction of pit privies in the mountainous areas of Virginia has apparently been effective in reducing the hookworm incidence because when present they are usually used by older children and adults who in the absence of a privy retired to protected shaded areas which frequently were of the proper soil consistency to serve as culture media for the free living stage of the hookworm. The introduction of the privy, however, has apparently done little to control the <u>Ascaris</u> burden in many areas because regardless of the presence or absence of a privy the younger children deposit their stools close to the house and in playgrounds where the eggs are readily conveyed by dirty hands and food to the mouth. The pollution of such areas does not to any extent at least spread hookworm, because the hard, rather dry soil in these places is unsuitable for the development of the hookworm larvae."	Otto, and Spindler (1930)
U.S.A.	Environmental studies were made of 329 families in the mountain region of Tennessee and 202 families living in the central basin, western plains, and lowlands of the state. The <u>Ascaris</u> and <u>Trichuris</u> infections were confined largely to the mountain areas.	Heavy <u>Ascaris</u> infection was associated with heavy contamination of the yard with ova. Yard pollution, and with it heavy <u>Ascaris</u> infection, were present regardless of the presence or absence of latrines.	Otto, Cort, and Keller (1931)

Country	Type of study	Result	Source																
U.S.S.R.	A "before and after" study was undertaken on a village of 1,600 people. The intervention measures included the abandoning of the use of untreated night soil as a fertilizer and "improving general hygiene."	Before the intervention, the prevalence of <u>Ascaris</u> ova was 100% in forty soil samples and 71 percent in twenty-eight fruit samples. Forty-one percent of soil eggs and nineteen percent of fruit eggs were viable. After the intervention, 35 percent of soil samples, and 25 percent of fruit samples contained eggs. No eggs were viable.	Rosenberg (1960)																
Iran	A study of ascariasis was conducted in a village of 850 people in Southwest Iran before and after the construction of a water supply serving public taps, a public bathhouse, a laundry (with six taps) and 114 pit latrines (nearly one for every household).	The prevalence of infection fell from 67 percent to 57 percent over the study period (February 1963 to December 1965). Mean egg output fell from around 11 per milligram of feces to 4. The authors believe that it is the pit latrines that were the major cause of this improvement - partly because the water supply was not working properly until late 1965. The cost of the latrines was US \$3.65 each (for US \$0.50 per capita) and a substantial part of this cost was met by the community on a self-help basis.	Sahba and Arfaa (1967)																
U.S.A.	Studies were conducted in eleven mining camps in eastern Kentucky from 1954-57. Reported diarrheal disease rates, <u>Shigella</u> isolation from rectal swabs of preschool children, and parasite prevalence were investigated. The comparison of health according to sanitary facilities is made for all eleven camps and this introduces the problem of confounding socioeconomic variables, which the authors discuss at length. For example, in group A camps the estimated family income is \$4,800 per year with 100 percent of houses having flush toilets and internal water. In group C camps, the family income is \$3,000 per year, and the percentages of houses with flush toilet and internal water are 7 percent and 19 percent respectively.	<p>The following results are relevant:</p> <table border="1"> <thead> <tr> <th>Facilities</th> <th>Diarrhea per 100 per year</th> <th><u>Shigella</u> prevalence</th> <th><u>Ascaris</u> prevalence</th> </tr> </thead> <tbody> <tr> <td>Water + flush toilet inside</td> <td>14</td> <td>1.1 percent</td> <td>7 percent</td> </tr> <tr> <td>Water inside, latrine outside</td> <td>24</td> <td>2.4 percent</td> <td>25 percent</td> </tr> <tr> <td>Water and latrine outside</td> <td>36</td> <td>5.9 percent</td> <td>42 percent</td> </tr> </tbody> </table>	Facilities	Diarrhea per 100 per year	<u>Shigella</u> prevalence	<u>Ascaris</u> prevalence	Water + flush toilet inside	14	1.1 percent	7 percent	Water inside, latrine outside	24	2.4 percent	25 percent	Water and latrine outside	36	5.9 percent	42 percent	Schliessmann et al. (1958)
Facilities	Diarrhea per 100 per year	<u>Shigella</u> prevalence	<u>Ascaris</u> prevalence																
Water + flush toilet inside	14	1.1 percent	7 percent																
Water inside, latrine outside	24	2.4 percent	25 percent																
Water and latrine outside	36	5.9 percent	42 percent																
Egypt	A major investigation into the effect of pit latrines on disease in Egyptian villages over a six-year period from 1928. Some villages received latrines alone, some received drugs and latrines, and some received nothing. Experimental design was unsatisfactory and the data were difficult to interpret. The authors investigated the impact of these interventions on infection with <u>Ascaris</u> , hookworm, and schistosomes. They expected that hookworm and schistosomiasis might be unaffected by latrines in the villages because transmission occurs mainly in the fields.	The authors concluded that "the inescapable conclusion from these experiments is that the sanitation produced no measureable effect on infection with the four species of worm parasites under study." The authors explain this lack of impact primarily by the suggestion that most transmission occurs away from the village in the fields. Insufficient behavioral data are provided, however, to indicate how the latrines were maintained and used and whether the transmission of <u>Ascaris</u> was really primarily away from the village.	Scott and Barlow (1938)																

Country	Type of study	Result	Source												
U.S.A.	<u>Shigella</u> infection data from 28,000 rectal swabs were analyzed according to the type of housing. Housing was divided into four categories (poor, fair, good, very good) according to water supply, excreta disposal, fly population, and aesthetic and structural quality.	The rates of new <u>Shigella</u> infections occurring during the study period were: poor housing 6.2 percent fair housing 2.2 percent good housing 0.6 percent very good housing 0.3 percent The role of excreta disposal facilities as a single variable did not emerge from this study.	Stewart <u>et al.</u> (1955)												
Panama	Surveys were conducted over seven years into environmental conditions and helminthiases in Panama.	In villages without latrines, the prevalence and intensity of hookworm rose to, or above, original levels within three or four years after a mass drug campaign. In villages with latrines, prevalence and intensity also rose again following drug treatment but some small degree of protection against reinfection was observed amongst women.	Sweet <u>et al.</u> , 1929												
Bangladesh, Egypt, Iran, Mauritius, Sri Lanka, Sudan and Venezuela	This paper summarises studies on diarrheal disease carried out in Mauritius (1960), Sudan (1961), Egypt (1961), Sri Lanka (1962), Iran (1963), Bangladesh (1964), and Venezuela (1965). Each study took place over a three to eleven month period and most of the studies were not rigorously designed. The main environmental focus was water supply rather than excreta disposal.	Little data specifically on the effect of excreta disposal emerge. In Mauritius, the following diarrheal rates were recorded: <table border="1" style="margin-left: 20px;"> <thead> <tr> <th>Facility</th> <th>Reported diarrhea per 100 people</th> </tr> </thead> <tbody> <tr> <td>Indoor toilet</td> <td>0.5</td> </tr> <tr> <td>Outdoor toilet</td> <td>1.9</td> </tr> <tr> <td>No toilet</td> <td>4.8</td> </tr> </tbody> </table> It is not clear whether extraneous variables were controlled in this comparison. From Sudan, evidence is presented to indicate that in one particular month, families having a communal unsanitary privy experienced a higher diarrheal morbidity rate than similar families having no toilet.	Facility	Reported diarrhea per 100 people	Indoor toilet	0.5	Outdoor toilet	1.9	No toilet	4.8	Van Zijl (1966)				
Facility	Reported diarrhea per 100 people														
Indoor toilet	0.5														
Outdoor toilet	1.9														
No toilet	4.8														
Costa Rica	An outbreak of 167 cases of infectious hepatitis (IH) was investigated between December 1963, and July 1964 in Costa Rica. The outbreak occurred during a severe drought. Person-to-person contact was considered the likely mode of spread.	The following data on excreta disposal were presented: <table border="1" style="margin-left: 20px;"> <thead> <tr> <th>Facility</th> <th>No. of houses</th> <th>Percent of houses with IH case</th> </tr> </thead> <tbody> <tr> <td>Flush toilet</td> <td>868</td> <td>1.6</td> </tr> <tr> <td>Outdoor latrine</td> <td>3.318</td> <td>2.7</td> </tr> <tr> <td>None</td> <td>905</td> <td>2.6</td> </tr> </tbody> </table>	Facility	No. of houses	Percent of houses with IH case	Flush toilet	868	1.6	Outdoor latrine	3.318	2.7	None	905	2.6	Villarejos <u>et al.</u> (1966)
Facility	No. of houses	Percent of houses with IH case													
Flush toilet	868	1.6													
Outdoor latrine	3.318	2.7													
None	905	2.6													

Country	Type of study	Result	Source
Costa Rica (continued)		The excreta disposal variable, however, is highly confounded with other relevant variables and the authors consider availability of water to be a more important factor.	Villarejos <u>et al.</u> (1964) (continued)
Egypt	A wide range of data were collected in five villages. Particular emphasis was on mortality, environmental conditions, and infectious disease problems. Village 1 received water, latrines, refuse disposal, fly control, and medical activities. Village 2 received water, latrines, refuse disposal, and fly control. Village 3 received water, latrines, and refuse disposal. Village 4 received water and fly control. Village 5 was a control. Water supply was a hand-pumped well for every 200 people and it is reported that latrines "were used readily by the villagers when it was convenient for them to do so." The first eighteen months were devoted to baseline data collection, the second eighteen months to the interventions, and the following year (1951) to evaluation of the impact.	This study was beset by methodological and statistical problems. For instance, a major variation occurred in the infant mortality rates in Village 5 between 1950 and 1951. The authors conclude "the installation of sanitary water supply and latrines did not alter the infant mortality or crude death rates and did not change the fly status in any of the villages in 1951." Later they say "under the present situation in the villages it was possible to improve sanitation only through installation of water supplies and latrines. Such installations in a village, without parallel improvement in housing, social, and economic status, do not appear to have a marked effect upon the death rate in infants and therefore presumably little or no effect on the rate of dysenteries in infants."	Weir <u>et al.</u> (1952)

APPENDIX III
REPORTED SURVIVAL TIMES FOR EXCRETED ORGANISMS
IN FECES, NIGHT SOIL AND SLUDGE

Organism	Initial Concentration	Environment	Temperature	Survival	Source
Polio 1	?	Sludge Sludge	4°C 22°C	> 14 days > 14 days	Subrahmanyam (1977)
Echo 9		Sludge	22°C	> 12 weeks	
Echo 6		Sludge	22°C	< 12 weeks	
Coxsackie B5		Sludge	22°C	> 12 weeks	
Coxsackie P4		Sludge	22°C	< 4 weeks	
Coxsackie B2		Sludge	22°C	< 5 weeks	
Coxsackie A9		Sludge	22°C	< 2 weeks	
Polio 3 (vaccine)		Sludge	22°C	< 12 weeks	
Polio 3 (virulent)		Sludge	22°C	< 8 weeks	
Polio 1 (vaccine)		Sludge	22°C	< 8 weeks	
Polio 1 (virulent)		Sludge	22°C	< 12 weeks	
Reovirus		Sludge	22°C	< 8 weeks	
<u>E. coli</u>	10 ³ -10 ⁵ /mg	Stored feces	10°C	Approximated at initial concentration after 2-3 months	Jordan (1926)
	10 ³ -10 ⁵ /mg	Stored feces	20°C	Low concentration after 6-8 weeks	
	10 ³ -10 ⁵ /mg	Stored feces	37°C	Very low concentration after 7-10 days.	
	?	Feces stored under garden soil	20°C	< 19 weeks	
	?	Feces stored under sand	20°C	< 12 weeks	
<u>S. typhi</u>	?	Naturally infected feces in vault	?	> 5 months	Levy and Kayser (1903) (quoted by Creel, 1912)
<u>S. typhi</u>	?	Feces in a pit or a container	1-26°C	< 30 days	Galvagno and Calderini (1908)
<u>S. typhi</u>	?	Feces	?	< 10 days longer survival in solid than in liquid stools	Kligler (1921) (quoted by Rudolfs, Falk, and Ragotzkie, 1950: 1)
<u>Sh. dysenteriae</u>	?	Feces	?	< 8 days	

Organism	Initial Concentration	Environment	Temperature	Survival	Source
<u>S. typhi</u>	?	Feces inoculated with <u>S. typhi</u>	20°C	< 21 days	Jordan (1926)
	?	Stools of typhoid carriers	20°C	< 62 days	
<u>S. typhi</u>	?	Untreated sludge	Room temperature	< 11 days	Mom and Schaeffer (1940)
	?	Sludge pasteurized for 10 mins at 80°C	Room temperature	< 16 days	
	?	Sludge sterilized for 30 minutes at 110°C	Room temperature	> 30 days	
<u>S. typhi</u>	?	Stored	20 - 22°C	< 14 days	Snell (1943) (quoting others)
<u>S. paratyphi</u>		Excreta			
<u>Sh. dysenteriae</u>		Feces and urine	15 - 17°C	< 28 days	
			8 - 10°C	< 70 days	

Organism	Initial Concentration	Environment	Temperature	Survival	Source
<u>S. typhimurium</u>	9500/ml	Sludge	28°C 6°C	< 4 days < 25 days	Braga (1964)
<u>S. typhi</u>	7870/ml	Sludge	28°C 6°C	< 5 days < 32 days	
<u>S. cholerae-suis</u>	6250/ml	Sludge	28°C 6°C	< 9 days < 38 days	
<u>S. enteritidis</u>	6450/ml	Sludge	28°C 6°C	< 5 days < 20 days	
<u>S. dublin</u>	10 ⁵ -10 ⁶ /ml 10 ⁵ -10 ⁶ /ml 10 ⁵ -10 ⁶ /ml	Cattle slurry Cattle slurry Cattle slurry	5-10°C 20°C 13°C	<132 days < 57 days < 13 days	Jones (1976)
<u>S. typhimurium</u>	10 ⁵ /ml	Cattle slurry (5.5% solids)	10°C	<140 days	
<u>S. stanley</u>	10 ⁵ /ml	Cattle slurry (5.5% solids)	10°C	<113 days	
<u>S. cholerae-suis</u>	10 ⁵ /ml	Cattle slurry (5.5% solids)	10°C	<140 days	
<u>V. cholerae</u>	10 ⁷ -10 ⁹ /ml	Rice water stool	26°C	< 5 days	Greig (1914)
<u>V. cholerae</u>	?	Stools from cholera patients and carriers	?	> 3 days	Gildemeister and Baerthlein (1915) (quoted by Webber, 1974)

Organism	Initial Concentration	Environment	Temperature	Survival	Source
<u>V. cholerae</u>		Cholera stools	37°C	< 1 day	Koreyeda, and Otomo Shoda (1934)
			28-31°C	< 1 day	
		Solid	Ice box	< 1 day	
		Pulpy	Ice box	< 4 days	
		Watery	Ice box	< 8 days	
		Artificial Cholera stools	37°C	< 6 hours	
			13-15°C	< 3 days	
			Ice box	< 5 days	
		Artificial Cholera Stools + Peptone water	37°C	< 1.5 days	
			13-16°C	> 17 days	
		Ice box	> 17 days		
Bovine tubercle bacilli	?	Cow feces on pasture	Winter	> 5 months	Williams and Hoy (1930)
				< 6 months	
			Spring	> 2 months	
				< 4 months	
		Autumn	> 4 months		
			< 5 months		
		(shaded)	Summer	> 4 months	
		< 5 months			
Cow feces stored in a jar in dark cool cellar (naturally infected) (artificially infected)			?	< 18 months	
			?	> 2 years	
Bovine tubercle	?	Cow feces, field conditions U.K., June-December	?	< 6 months	Maddock (1933)

Organism	Initial Concentration	Environment	Temperature	Survival	Source
<u>Leptospira icterohaemorrhagiae</u>	?	Fecal emulsion	26°C	< 1 day	Noguchi (1918)
		Sterile faecal filtrate	26°C	< 4 days	
		Urine + NaOH	26°C	< 2 days	
		Urine	26°C	< 1 day	
<u>Ent. histolytica</u>	?	Feces	27-30°C	< 8 days	Kuenen and Swellengrebel (1913) (quoted by Chang, 1943)
		Feces	37°C	< 2 days	
<u>Ent. histolytica</u>	?	Undiluted feces	-6-0°C	< 1-4 days	Simitch, Petrovitch, and Chibalitch (1954)
		Undiluted feces	2-6°C	< 20-40 days	
		Undiluted feces	25-37°C	< 1-4 days	
		Feces diluted in distilled water	-6-0°C	< 1-3 days	
		Feces diluted in distilled water	2-6°C	< 20-40 days	
		Feces distilled water	25-37°C	< 1-6 days	
Hookworm larvae	?	Moist feces	Room temperature	< 13 months	Augustine (1922)
Hookworm ova	10 ² -10 ³ /g	Night soil (diluted with water) stored in jars	9-28°C	90% die in 1 month and almost all in 2 months	Oldt (1926)
	10 ² -10 ³ /g	Night soil mixed with equal parts of refuse	9-28°C	Almost all die in 4 weeks	
	10 ² -10 ³ /g	Night soil + 25% ammonium sulphate	9-28°C	Almost all die in 1 week	

Organism	Initial Concentration	Environment	Temperature	Survival	Source
<u>Clonorchis sinensis</u> ova	?	Fresh night soil	41°C	< 24 hours	Faust and Khaw (1927)
		Fresh night soil	37°C	< 24 days	
		Fresh night soil	6-8°C	< 5 days	
		5-day-old night soil			
		night soil	6-8°C	< 2 days	
		10 day-old night soil	6-8°C	< 1 hour	
		Fresh urine	6-8°C	< 7 days	
		Fresh urine	37°C	< 2 days	
			41°C	< 2 days	
			Old urine	6-8°C	
	Old urine	26°C	< 9 hours		
Hookworm ova	8x10 ² -3x10 ⁴ /ml	Stored feces	Room temperature (Calcutta)	55% reduction after 10 days	Maplestone (1928)
<u>Taenia saginata</u> ova	60 gravid segments	Stored underground in liquid manure (May-July, Denmark)	?	> 71 days	Jepsen and Roth (1949)
<u>Schistosoma japonicum</u> ova	?	Rabbit feces	8°C	< 180 days	Ito (1954)
			18°C	< 113 days	
			28°C	< 20 days	
		Rabbit urine	8°C	< 4 days	
			18°C	< 2 days	
			28°C	< 1 day	
		Human urine	8°C	< 12 days	
			18°C	< 6 days	
			28°C	< 3 days	
<u>Hymenolepis nana</u> ova	?	In compact stools indoors	0°C	> 6 days	Simitch, Bordjochki, and Angelovski (1955)
			2°C	> 10 days	
			20°C	> 48 hours	
				< 72 hours	
			37°C	> 4 hours	
				< 8 hours	
	> 2 hours				
	< 4 hours				

Organism	Initial concentration	Environment	Temperature	Survival	Source
<u>Hymenolepis nana ova</u> (continued)	?	Exposed to direct sunlight	40-42°C	> 2 hours < 3 hours	Simitch, Bordjochki, and Angelovski (1955) (continued)
		In crumbled stools indoors	20°C	> 24 hours < 30 hours	
			37°C	> 2 hours < 4 hours	
			41-42°C	> 1 hour < 3 hours	
		Exposed to direct sunlight	40-42°C	> 1 hour < 2 hours	
		Stools kept in water indoors	20°C 37°C	> 30 days > 80 hours < 120 hours	
			41-42°C	> 6 hours < 10 hours	
		Exposed to direct sunlight	40-42°C	> 24 hours < 30 hours	
<u>Ascaris ova</u>	?	Liquid night soil stored in vaults	Summer Winter	< 2 weeks < 1 month	Hou Tsung-Chang et al. (1959)
<u>Ascaris ova</u>	?	Night soil digested anaerobically	25-32°C	> 45 days	Reyes, Kruse, and Batson (1963)
	?	Night soil digested aerobically	8-30°C	> 30 days	
<u>Fasciolopsis buski ova</u>	?	Human urine	?	< a few hours	Komiya (1964)
<u>Ascaris ova</u>	?	Night soil	30°C 32°C 34°C	< 40 days < 25 days < 11 days	Nishi (1969)

Organism	Initial concentration	Environment	Temperature	Survival	Source
<u>Ascaris ova</u>	?	Human urine undiluted	?	< 16 hours	Hamdy (1970)
		5-20%	?	< 4 days	
		1-2%	?	< 15 days	
<u>Fasciola hepatica ova</u>	?	Liquid manure	4-8°C 15-18°C	< 101 days < 70 days	Six and Hoffmann (1970)

APPENDIX IV

REPORTED SURVIVAL TIMES FOR EXCRETED ORGANISMS IN WATER AND SEWAGE

Organism	Initial concentration	Environment	Temperature	Survival	Source
Hepatitis A	?	Contaminated well water	20-23°C	> 10 weeks	Neefe and Stokes (1945) (quoted by Clarke and Chang, 1959)
Polio	?	River water with 1:200 added feces	8-10°C	> 188 days	Rhodes et al. (1950a) (quoted by Clarke and Chang, 1959)
Polio	?	Sewage	refrigerator	> 90 days	Rhodes et al. (1950b)
Coxsackie A2	5x10 ⁴ LD ₅₀ /ml*	Sewage	8°C	> 61 days < 117 days	Clarke, Stevenson, and Kabler (1956)
	5x10 ⁴ LD ₅₀ /ml	Sewage	20°C	> 41 days < 61 days	
	5x10 ⁴ LD ₅₀ /ml	Distilled water	8°C	> 272 days	
	5x10 ⁴ LD ₅₀ /ml	Distilled water	20°C	> 41 days < 135 days	
	5x10 ⁴ LD ₅₀ /ml	Moderately polluted river water	8°C	> 16 days < 24 days	
	5x10 ⁴ LD ₅₀ /ml	Clean river water	20°C	< 4 days	
	5x10 ⁴ LD ₅₀ /ml	Moderately polluted river water	20°C	> 4 days < 16 days	

* LD₅₀ = median lethal dose.

Organism	Initial concentration	Environment	Temperature	Survival	Source
Coxsackie A2 (continued)	5×10^4 LD ₅₀ /ml	Grossly polluted	20°C	> 31 days < 72 days	Clarke, Stevenson, and Kabler (1956) (continued)
Polio 1	?	Clean river water	4°C 20°C 28°C	99.9% reduction in: 27 days 20 days 17 days	Clarke <u>et al.</u> (1962)
		Moderately polluted river water	4°C 20°C 28°C	19 days 13 days 11 days	
		Sewage	4°C 20°C 28°C	110 days 23 days 17 days	
Echo 7	?	Clean river water	4°C 20°C 28°C	26 days 16 days 12 days	
		Moderately polluted river water	4°C 20°C 28°C	15 days 7 days 5 days	
		Sewage	4°C 20°C 28°C	130 days 23 days 17 days	
Echo 12	?	Clean river water	4°C 20°C 28°C	33 days 12 days 5 days	

Organism	Initial concentration	Environment	Temperature	Survival	Source
Echo 12 (continued)		Moderately polluted river water	4°C	20 days	99.9% reduction in: Clarke <u>et al.</u> (1962) (continued)
			20°C	19 days	
			28°C	5 days	
		Sewage	4°C	60 days	
			20°C	32 days	
			28°C	20 days	
Coxsackie A9	?	Clean river water	4°C	10 days	
			20°C	< 8 days	
			28°C	< 8 days	
		Moderately polluted river water	4°C	20 days	
			20°C	8 days	
			28°C	5 days	
		Sewage	4°C	12 days	
			28°C	6 days	
		Coxsackie A2	?	sewage	
20°C	< 41 days				
<u>E. coli</u>	?	Phosphate buffer (Aerobic)	?	50-90% reduction in 12 days	Allen, Pasley, and Pierce, 1952)
		(Anaerobic)	?	95-99% reduction in 5-9 days	
<u>Strep. fecalis</u>	?	Phosphate buffer (aerobically or anaerobically)	?	99% reduction in 14 days	

Organism	Initial concentration	Environment	Temperature	Survival	Source
Fecal coliform	10 ² -10 ³ /ml	Raw river water	0-2°C dark	> 20 days	Platt (1953)
			18°C dark	< 1 day	
			18°C	< 1 day	
			37°C dark	< 1 day	
	> 10 ⁴ /ml	Raw river water	0-2°C dark	< 58 days	
			18°C dark	< 1 day	
18°C			< 5 days		
37°C dark			< 5 days		
Coliform	> 10 ⁴ /ml		0-2°C dark	< 65 days	
			18°C dark	< 72 days	
			18°C	< 44 days	
			37°C dark	< 16 days	
<u>B. aerogenes</u>	10 ² -10 ³ /ml	Raw river water	0-2°C dark	< 20 days	
			18°C dark	< 9 days	
			18°C	< 1-5 days	
			37°C dark	< 5 days	
	> 10 ⁴ /ml	Raw river water	0-2°C dark	< 58 days	
			18°C dark	< 72 days	
18°C			< 44 days		
37°C dark			< 16 days		
<u>E. coli</u>	?	Sewage	4°C	99.9% reduction in: 48 days	Clarke and Kabler (1964)
				28°C	

Organism	Initial concentration	Environment	Temperature	Survival	Source
				99.9% reduction in:	Clarke and Kabler (1964) (continued)
<u>Strep. fecalis</u>	?	Sewage	28°C	48 days	
	?	Sewage	28°C	14 days	
<u>A. aerogenes</u>	?	Sewage	4°C	56 days	
		Sewage	28°C	10 days	
Coliform	10 ³ -10 ⁴ /ml	1% diluted sewage D.O. = 0.3-0.4 ppm	20°C	90% reduction in 20 days	Hanes, Sarles, and Rohlich (1964)
		1% diluted sewage D.O. = 7.6-8 ppm	20°C	90% reduction in 6-7 days	
		1% diluted sewage D.O. = 37-38 ppm	20°C	90% reduction in 8 days	
Enterococci	10 ² -10 ³ /ml	1% diluted sewage D.O. = 0.3-0.4 ppm	20°C	99% reduction in 20 days	
		1% diluted sewage D.O. = 7.4-7.9 ppm	20°C	99% reduction in 7 days	
		1% diluted sewage D.O. = 37 ppm	20°C	99% reduction in 6 days	
<u>A. aerogenes</u>	10 ⁵ -10 ⁶ /ml	Farm pond water	20°C	> 35 days	Andre, Weisser, and Malaney, (1967)

Organism	Initial Concentration	Environment	Temperature	Survival	Source
				50% reduction in:	
Coliform	10^5 /ml	Well water	9.5-12.5°C	17 hours	McFeters <u>et al.</u> (1974)
Enterococci	10^5 /ml	Well water	9.5-12.5°C	22 hours	
Streptococci	10^5 /ml	Well water	9.5-12.5°C	19.5 hours	
<u>E. coli</u>	?	Spring water	?	< 1 month	Gray (1975)
<u>S. typhi</u>	10^4 /ml	Raw river water	1.4°C	< 2 days	Jordan, Russell, and Zeit (1904)
	$1.5-2 \times 10^6$ /ml	Raw river water	12-14°C	< 4 days	
	10^6 /ml	Tap water	7-16°C	< 9 days	
	$1.5-2 \times 10^6$ /ml	Sterile tap water	1.9°C	< 26 days	
	500/ml	Filtered tap water	20°C	< 5 days	
	10^3 /ml	0.6% sterile salt solution	1-8°C	> 10 days < 3 days	
	10^3-10^6 /ml	Sewage	9-17°C	> 3 days	
<u>S. typhi</u>	6×10^5 /ml	Sterile tap water aerobic	20°C	< 47 days	Whipple and Mayer (1904)
	1.4×10^6 /ml	Anaerobic	20°C	< 2 days	
<u>S. typhi</u>	10^3-10^6 /ml	Lake water	9-12°C	< 10 days	Russell and Fuller (1906)
		Aerobic	21-23°C	< 13 days	
	?	Sewage	21-29°C	< 5 days	

Organism	Initial concentration	Environment	Temperature	Survival	Source
<u>S. typhi</u>	10^2-10^5 /ml	Distilled water	10-12°C dark	< 17 days	Wheeler ()
			20-22°C dark	< 37 days	
			20-22°C light	< 13 days	
		Tap water	10-12°C dark	< 21 days	
			20-22°C dark	< 43 days	
			20-22°C light	< 15 days	
		Polluted well water	10-12°C dark	< 37 days	
			20-22°C dark	< 79 days	
			20-22°C light	< 15 days	
<u>S. typhi</u>	?	River water	0°C	< 9 weeks	Houston (1913) (quoted by Rudolfs, Falk, and Ragotzkie. (1950:1))
			5°C	< 7 weeks	
			10°C	< 5 weeks	
			18°C	< 4 weeks	
			27°C	< 3 weeks	
			37°C	< 2 weeks	
<u>S. typhi</u>	10^4 /ml	Sewage	37°C	< 1 day	Heukelekian and Schulhoff (1935)
			22°C	< 2 days	
			2°C	< 17 days	
		Polluted river water	37°C	< 1 day	
			22°C	< 2 days	
			2°C	< 12 days	
		unpolluted river water	22°C, 37°C	99% reduction in 60 hours	
			3°C	99% reduction in 3 days	

Organism	Initial concentration	Environment	Temperature	Survival	Source
<u>S. typhi</u>	6.5x10 ⁶ /ml	Sewage	14-20°C	> 19 days	Green and Beard (1938)
		indoors		< 27 days	
	5x10 ⁶ /ml	Sewage	0-18°C	> 27 days	
		outdoors		< 33 days	
<u>Sh. sonnei</u>	?	Seawater	15°C	<15->70 days (depending on strain)	Nakamura, Stone, and Krubsack (1964)
<u>Sh. flexneri</u>	?	Seawater	15°C	> 72 days	
<u>Sh. sonnei</u>	?	Artificial seawater	-13°C	< 43 days	
			8°C	< 23 days	
			15°C	> 106 days	
			25°C	> 106 days	
			37°C	< 23 days	
<u>Salmonella</u>	10 ⁴ -10 ⁷ /ml	Farm pond water	20°C	< 16 days	Andre, Weisser, and Malaney (1967)
<u>Shigella</u>	10 ⁴ -10 ⁷ /ml	Farm pond water	20°C	< 12 days	
<u>Sh. dysenteriae</u>) <u>Sh. flexneri</u>) <u>Sh. sonnei</u>)	10 ⁵ /ml	Well water	9.5-12.5°C	Half-life 16-26 hours	McFeters et al. (1974)
<u>S. typhi</u>	10 ⁵ /ml	Well water	9.5-12.5°C	Half-life 6 hours	

Organism	Initial concentration	Environment	Temperature	Survival	Source			
<u>Sh. flexneri</u>	5×10^6 /ml	Tap water	23-25°C	6 days	Mohadjer and Mehrabian (1975)			
		River water	23-25°C	4 days				
		Filtered water	23-25°C	3 weeks				
		Autoclaved water	23-25°C	3.5 weeks				
		Tap water	4-6°C	10 days				
		River water	4-6°C	7 days				
		Filtered water	4-6°C	3 weeks				
		Autoclaved water	4-6°C	3 weeks				
		All four types	-8°C	> 1 month				
		99 % reduction in:						
<u>V. cholerae</u>	?	Sewage	37°C	< 1 day	Ohwada (1924) (quoted by Takano, Ohtsubo, and Inouye, 1926)			
			Room temp.	< 4 days				
			Ice chest	< 12 days				
<u>V. cholerae</u>	?	Ganges River water	Room temp.	< 2 days	Khan and Agarwal (1929)			
				< 3 days				
		Jumma River water	Room temp.	< 2 days				
				< 9 days				
		Well water raw	Room temp.	< 2 days				
				< 5 days				
		<u>V. cholerae</u>	?	2% seawater and peptone		37°C	> 5 days	Read et al. (1939)
		<u>V. cholerae</u>	10^6 /ml	Spring water		Room temp. (Calcutta)	< 1 hour	Lahiri, Das, and Malik (1939)
Tap water	Room temp. (Calcutta)			< 18 hours				

Organism	Initial concentration	Environment	Temperature	Survival	Source
<u>V. cholerae</u> (continued)		River water	Room temp. (Calcutta)	< 18 hours	Lahiri, Das, and Malik (1939) (continued)
		Tank water	Room temp. (Calcutta)	< 72 hours	
<u>V. cholerae</u>	?	Tank water pH = 6.4-6.6	?	< 2 days	Neogy (1965)
<u>V. cholerae</u> El Tor				< 8 days	
<u>V. cholerae</u> El Tor	1000/ml	Well water: from Jatauli village, Gurgoon district, Punjab	21°C 37°C	< 18 days < 4 days	Pandit <i>et al.</i> (1967)
		from Bhopura village Meerut district, Uttar Pradesh	21°C 37°C	< 51 days < 4 days	
		from Bhopura village diluted everyday with groundwater	25°C	< 12 days	
		48-hour-old tap water	21°C	< 12 days	
		Delhi water supply	37°C	< 1 day	
<u>V. cholerae</u> El Tor	10 ⁶ /ml	Chlorinated tapwater			Pesigan, Plantilla, and Rolda (1967)
	10 ⁶ /ml	Raw	30-32 C 5-10°C	< 1 hour < 1 hour	
			Exposed to sunlight	< 1 hour	
	10 ⁶ /ml	Autoclaved	30-32 C 5-10°C	< 39 hours < 298 hours	
			Exposed to sunlight	< 12 hours	

Organism	Initial concentration	Environment	Temperature	Survival	Source
<u>V. cholerae</u> El Tor (continued)	~ 10 ⁶ /ml	Deep well water raw	30-32°C	< 13 days	Pesigan, Plantilla, and Roldan (1967) (continued)
			5-10°C	< 18 days	
			Exposed to sunlight	< 4 days	
	~ 10 ⁶ /ml	Autoclaved	30-32°C	< 17 days	
			5-10°C	< 42 days	
			Exposed to sunlight	< 8 days	
	~ 10 ⁶ /ml	Raw seawater	30-32°C	< 13 days	
			5-10°C	< 60 days	
			Exposed to sunlight	< 11 days	
<u>V. cholerae</u>	10 ⁵ /ml	Well water	9.5-12.5°C	Half-life of 7 hours	McFeters <u>et al.</u> (1974)
<u>V. cholerae</u> El Tor	?	Naturally infected sewage	Laboratory conditions	< 39 days	Zaidenov (1976)
		Artificially infected sewage	Laboratory conditions	< 11 days	
		Sewage with high oil content	?	< 14 months	
Tubercle bacilli	5.5x10 ⁵ /ml	Tap water	20°C	Reduction of 90% in 6 days	Heukelekian and Albanese (1956)
	6.8x10 ⁵ /ml	Polluted tap water	20°C	Reduction of 85% in 6 days	
	1.9x10 ⁵ /ml	Brackish water	20 C	Reduction of 80% in 1 day	
	1.3x10 ⁵ /ml	Seawater	20°C	Reduction of 85% in 1 days	

Organism	Initial concentration	Environment	Temperature	Survival	Source
<u>Leptospira</u>	?	Distilled water	?	< 7 days	Noguchi (1918)
<u>icterohaemorrhagiae</u>	?	Contaminated water	?	< 2 days	
<u>Ent. histolytica</u>	?	Distilled water	12-22°C	< 153 days	Boeck (1921)
<u>Ent. coli</u>			12-22°C	< 244 days	
<u>Giardia lamblia</u>			12-22°C	< 32 days	
<u>Chilomastix mesnili</u>			12-22°C	< 187 days	
				99.9% reduction in:	
<u>Ent. histolytica</u>	5x10 ⁴ -10 ⁵ /ml	Various	4°C	55-60 days	Chang (1943)
		Various	6.8°C	38-42 days	
		Various	21-22°C	7-8 days	
		Normal salt solution	27.5°C	4.3 days	
		Normal salt solution	37°C	1.7 days	
		Normal salt solution	39.2°C	< 1 day	
<u>Ent. histolytica</u> (mature cysts)	?	Distilled water	28-34°C	> 2 days < 4 days	Beaver and Deschamps (1949)
(immature cysts)		Distilled water	28-34°C	> 4 days < 6 days	

Organism	Initial concentration	Environment	Temperature	Survival	Source
<u>Giardia</u> <u>Ent. coli</u>	(100 cysts of each in a beaker of water)	Aerated tap water Aerated tap water	8°C 8°C	> 16 days > 16 days	Rendtorff and Holt (1954: IV)
Hookworm larvae	?	Water	Room temp. (Germany)	< 1 year	Löbker and Eruns (1906) (quoted by Augustine, 1922)
Hookworm larvae	?	Water	Room temp. (Italy)	< 10 months	Augustine (1922) (quoting others)
Hookworm larvae	?	Water	15.5°C	< 18 months	Nicoll (1917) (quoted by Augustine, 1922)
Hookworm larvae	?	Water	Room temp. (U.K.)	< 15 months	Augustine (1922) (quoting others)
<u>D. latum</u> ova	?	Tap water contaminated with feces	-10°C 15°C	< 2 days > 8 months	Essex and Magath (1931)
<u>Taenia</u> <u>saginata</u> ova	3 gravid segments 3 gravid segments	Sewage Stream water	18°C 18°C	> 16 days > 33 days	Jepsen and Roth (1949)

Organism	Initial concentration	Environment	Temperature	Survival	Source
<u>Ascaris</u> ova	?	River water	? (USSR)	> 15 months	Usacheva (1951)
<u>Taenia</u> <u>saginata</u> ova	?	Saline	4°C	> 335 days	Silverman (1956)
	?	Saline	room temp.	< 60 days	
<u>Fasciola</u> <u>hepatica</u> ova	?	Distilled water (saturated with O ₂)	40°C	< 4 days	Becejac and Lui (1959)
			25 C	> 4 days	
	?	Distilled water D.O. = 1mg/l	40°C	< 13 days	
<u>Opistorchis</u> <u>felineus</u> ova	?	Water	-24°C 45°C	< 5 hours < 1 hour	Drozдов (1962)
		River water	0-5°C	Half-life > 160 days	
<u>D. latum</u> ova	?	Reservoir water	0°C	< 3 days	Chefranova (1964)
<u>Fasciola</u> <u>hepatica</u> miracidia	?	Brackish water	?	< 15 hours	Styczynska-
	?	Distilled water	?	< 2 hours	Jurewicz (1965)

Organism	Initial concentration	Environment	Temperature	Survival	Source
<u>Schistosoma</u> <u>mansoni</u> <u>miracidia</u>	?	Tap water (D.O. = 0.5 mg/l)	26°C	< 18 hours	Kawata and Kruse (1966)
		Aerobic stabilization pond water (D.O. = 9.2 mg/l pH = 4.5)	26°C	< 10 hours	
		Anaerobic stabilization pond water (D.O. = 0.5 mg/l pH = 7.8)	26°C	< 6 hours	
Ova		Sewage	26°C	< 2 days	

APPENDIX V

SURVIVAL OF EXCRETED ORGANISMS IN SOIL

Organism	Soil	Moisture	Temperature	Survival	Source
Enteroviruses	Sterile sandy soil	10% - 20%	3-10°C	< 130-170 days	Bagdasaryan (1964)
			18-23°C	< 90-110 days	
	pH 7.5	10% - 20%	3-10°C	< 110-150 days	
			18-23°C	< 40- 90 days	
	Non-sterile sandy soil	10% - 20%	3-10°C	< 110-170 days	
			18-23°C	< 40-110 days	
	pH 5	10% - 20%	3-10°C	< 90-150 days	
			18-23°C	< 25- 60 days	
	Sterile loamy soil	10% - 20%	3-10°C	< 70-150 days	
			18-23°C	< 70-110 days	
	pH 7.5	10% - 20%	3-10°C	< 90-150 days	
			18-23°C	< 25- 60 days	
	Nonsterile loamy soil	10% - 20%	3-10°C	< 110-150 days	
			18-23°C	< 70-110 days	
pH 5	10% - 20%	3-10 C	< 90-130 days		
		18-23°C	< 25- 60 days		
Nonsterile sandy soil	Air dried	18-23°C	< 15- 25 days		

Organism	Soil	Moisture	Temperature	Survival	Source
Poliovirus	Sand dunes	Dry Moist	? ?	< 77 days < 91 days	Lefler and Kott (1974) (quoted by Damgaard-Larsen <u>et al.</u> , 1977)
Poliovirus I	Loamy fine sand	Moist Moist	4°C 20°C	< 90% reduction in 84 days 99.999% reduction in 84 days	Duboise <u>et al.</u> (1976)
Polioviruses 2, and 3	Soil irrigated with effluent pH = 8.5	9 - 20 %	12-33°C	> 8 days	Sadovskii <u>et al.</u> (1976) (quoted by Fattal <u>et al.</u> , 1976)
Poliovirus B3	Clay pH = 7.1-7.4	Total rainfall = 300 mm	-12-28°C	< 161 days	Damgaard-Larsen <u>et al.</u> (1977)
Poliovirus I	Sludge or effluent-irrigated soil	Total rain = 180 mm	-14-27°C (winter) -14-27°C	> 96 days < 123 days after sludge application > 89 days < 96 days after effluent application	Tierney, Sullivan, and Larkin (1977)
		Total rain = 190 mm	15-33°C (spring)	< 11 days after sludge or effluent application	

Organism	Soil	Moisture	Temperature	Survival	Source
<u>E. coli</u>	?	10 - 40%	?	< 3 years	Young and Greenfield, (1923)
<u>E. coli</u>	Loam (air dried and sieved)	15%	?	< 136 days	Skinner and Murray (1926)
<u>E. coli</u>	Loam	30%	?	< 176 days	
<u>A. aerogenes</u>	Loam	30%	?	< 218 days	
<u>E. coli</u>	sterile garden soil	?	?	> 3.5 years	Kulp (1932) (quoted by Rudolfs, Falk, and Kagatzkie, 1950: I)
<u>A. aerogenes</u>	Sterile garden soil	?	?	> 3.5 years	
Coliform	Sand, sandy loam, clay loam, muck	?	?	> 11 weeks	Mallmann and Litsky (1951)
<u>Streptococci</u>	Sand	?	?	> 5 weeks	
				< 6 weeks	
	Loam	?	?	> 9 weeks	
				< 11 weeks	
Sandy loam	?	?	> 5 weeks		
			< 6 weeks		
Clay loam	?	?	> 7 weeks		
			< 8 weeks		

Organism	Soil	Moisture	Temperature	Survival	Source
Coliform	Red limestone irrigated with raw sewage				Bergner - Rabinowitz (1956)
	Surface	8% - 39%	2-21°C	99.999% reduction within 48 days	
	Depth of 100-200 mm	19% - 30%	2-21°C	99.9% reduction within 21 days	
	Surface	3% - 23%	25°C	99.9 reduction in 11 days	
	Depth of 100-200 mm	12% - 29%	25°C	99.9% reduction in 38 days	
Fecal coliform	Coarse loam rich in organic materials	Shaded	Spring	99% reduction in: 8-18 days	Van Donsel, Geldreich, and Clarke (1967)
			Summer	15-25 days	
			Autumn	45-55 days	
			Winter	25-40 days	
	Dense clay	Exposed to sunlight	Spring	15-25 days	
			Summer	10-15 days	
			Autumn	15-25 days	
			Winter	25-40 days	
Fecal streptococci	Coarse loam rich in organic materials	Shaded	Spring	45-55 days	
			Summer	20-28 days	
			Autumn	35-45 days	
			Winter	> 70 days	
	Dense clay	Exposed to sunlight	Spring	35-45 days	
			Summer	8-12 days	
			Autumn	20-25 days	
			Winter	> 70 days	

Organism	Soil	Moisture	Temperature	Survival	Source
Coliform	Fine sand	10%	22°C	90% reduction in 4 days (survival increasing with increasing rate of slurry application)	Dazzo, Smith, and Hubbell (1973)
<u>S. typhi</u>	Soil	?	22°C	> 5 1/2 months	Grancher and Deschamps (1889) (quoted by Rudolfs, Falk, and Ragotzkie, 1950: I)
<u>S. typhi</u>	Soil	?	?	< 3 months	Karlinski (1891) (quoted by Rudolfs, Falk, and Ragotzkie, 1950: I)
<u>S. typhi</u>	Sterile soil	?	?	> 18 days	Demster (1894) (quoted by Rudolfs, Falk, and Ragotzkie, 1950: I)
<u>S. typhi</u> in nutrient broth	Soil, with frequent addi- tion of nutrient	?	?	< 10 months	Robertson (1898) (quoted by Rudolfs, Falk, and Ragotzkie, 1950: I)
	Soil	?	?	< 4 months	

Organism	Soil	Moisture	Temperature	Survival	Source
<u>S. typhi</u> in nutrient broth	Sterile contaminated soil	?	?	> 400 days	Martin (1897-1900) (quoted by Rudolfs, Falk, and Ragotzkie, 1950: I)
<u>S. typhi</u> in nutrient broth	Soil sterile soil	? ?	? ?	> 100 days > 216 days	Rullmann (1901) (quoted by Rudolfs, Falk, and Ragotzkie, 1950: I)
<u>S. typhi</u>	Soil Sand	? dry	? ?	< 74 days < 24 days	Firth and Horrocks (1902) (quoted by Rudolfs, Falk, and Ragotzkie, 1950: I)
<u>S. typhi</u>	Soil	dry	?	99% reduction in 2 weeks	Sedgwick and Winslow (1902) (quoted by Rudolfs, Falk, and Ragotzkie, 1950: I)
<u>S. typhi</u>	Soil fertilized with feces stored in a pit	?	Air temp. 4-20°C	< 20 days	Galvagno and Calderini (1908)

Organism	Soil	Moisture	Temperature	Survival	Source
<u>S. typhi</u> (fresh and old cultures)	Sandy soil	?	16-17 C	< 29 days (fresh)	Melick (1917)
			16-17°C	< 36 days (old)	
	Garden soil	?	14-17°C	< 32 days (fresh)	
			14-17°C	< 58 days (old)	
	Sandy soil	?	Hot house	< 53 days (old)	
Garden soil (enriched with sterile sewage and broth)	?	Hot house	< 49 days (fresh)		
		Hot house	< 74 days (old)		
typhoid stools	Sandy soil	?	15°C	< 41 days	
	Soil	?	21°C	< 35 days	
<u>S. typhi</u>	Garden soil	?	?	> 36 days	Murillo (1919) (quoted by Rudolfs, Falk, and Ragotzkie, 1950: I)
	Sterile sand	?	?	> 55 days	
<u>S. typhi</u>	Soil	Moist	?	< 80 days	Kligler (1921) (quoted by Rudolfs, Falk, and Ragotzkie, 1950: I)
	Soil	Dry	?	< 20 days	
	Soil	Acid	?	< 10 days	

Organism	Soil	Moisture	Temperature	Survival	Source
<u>S. typhi</u>	Sand	256 mm rain	4-15°C	> 15 days	Beard (1940)
				< 30 days	
	18 mm rain	12-26°C	> 7 days		
				< 14 days	
	Loam	256 mm rain	4-15°C	> 120 days	
		18 mm rain	12-26°C	> 42 days	
	Loamy sand	256 mm rain	4-15°C	> 60 days	
				< 75 days	
	18 mm rain	12-26°C	> 14 days		
				< 21 days	
	Adobe	256 mm rain	4-15°C	> 105 days	
				< 120 days	
	18 mm rain	12-26°C	> 28 days		
				< 35 days	
Adobe-peat	256 mm rain	4-15°C	> 90 days		
			< 105 days		
18 mm rain	12-26°C	> 42 days			
Peat	81 mm rain	4-15°C	< 2 days		
	50 mm rain	12-20°C	< 2 days		
<u>S. typhi</u>	Sand	?	?	< 5 days	Mallmann and Litsky (1951)
	Sandy loam	?	?	> 5 days	
	Clay loam	?	?	> 12 days	
	Muck	?	?	> 12 days	

Organism	Soil	Moisture	Temperature	Survival	Source
<u>S. tennessee</u>	Red limestone irrigated with raw sewage				Bergner-Rabinowitz (1956)
	Surface	8-39%	2-21°C	< 46 days	
	Depth of 100 mm	19-30%	2-21°C	< 70 days	
	Surface	3-23%	25°C	> 11 days < 15 days	
	Depth of 100-200 mm	12-29%	25°C	> 8 days < 11 days	
<u>S. abortus bovis</u>	Soil	?	?	Reduction of: 50% in 4 days 90% in 16 days 99% in 25 days 99.9% in 50 days	Delage (1961)
<u>S. paratyphi B</u>	Soil	?	?	> 259 days	Thomas (1967)
<u>S. typhimurium</u>					Tannock and Smith (1972)
Distilled water suspension	Soil	Exposed	Winter	< 4 weeks	
	Soil	Exposed	Summer	< 4 weeks	
	Soil	Shaded	Winter	< 6 weeks	
	Soil	Shaded	Summer	< 10 weeks	
10% fecal suspension	Soil	Exposed	Winter	< 6 weeks	
	Soil	Exposed	Summer	< 4 weeks	
	Soil	Shaded	Winter	< 6 weeks	
	Soil	Shaded	Summer	< 10 weeks	
	Soil cover	Exposed	Winter	< 10 weeks	
Soil cover	Exposed	Summer	> 18 weeks		

Organism	Soil	Moisture	Temperature	Survival	Source
<u>typhimurium</u> (continued)					Tannock and Smith (1972)
Filtered water suspension	Sheep feces	Exposed	Winter	< 6 weeks	(continued)
	Sheep feces	Exposed	Summer	< 14 weeks	
	Sheep feces	Shaded	Winter	< 14 weeks	
	Sheep feces	Shaded	Summer	< 16 weeks	
Fecal suspension	Sheep feces	Exposed	Winter	< 6 weeks	
	Sheep feces	Exposed	Summer	< 12 weeks	
	Sheep feces	Shaded	Winter	< 10 weeks	
	Sheep feces	Shaded	Summer	< 18 weeks	
<u>enteritidis</u>	Fine sand	10%	22°C	Reduction of: 90% in 2 days 99% in 5 days (increasing survival with increasing rate of slurry application)	Dazzo, Smith, and Hubbell (1973)
<u>vine tubercle</u> <u>scilli</u>	Soil and dung	?	? (England)	< 178 days	Maddock (1933)
<u>otospira</u> <u>stero-</u> <u>hemorrhagiae</u>	Soil	?	?	< 72 hours	Noguchi (1918)

Organism	Soil	Moisture	Temperature	Survival	Source
Leptospires	Exposed soil PH = 5.3-6.2	9.5-16.5%	Summer	< 12 hours	Karaseva, Chernukha, and Piskunova
	Marshy soil pH = 6.9-7.4	40-60%	Summer	< 7 days	
	Very shaded pH = 6.5-7.5	70-77%	Summer	< 15 days	
<u>E. histolytica</u>	Loam and sand	Damp	28-34°C	> 8 days < 10 days	Beaver and Deschamps (1949)
<u>E. histolytica</u>	Soil	Moist	?	> 42 hours < 72 hours	Rudolfs, Falk, and Ragotzkie (1951: II)
		Dry	?	> 18 hours < 42 hours	
Hookworm larvae	Sand	?	Room temp.	< 4 months	Augustine (1922) (quoting others)
Hookworm larvae	Soil	?	Open shade Sumatra	< 6 months	Baermann (1917) (quoted by Augustine, 1922)

Organism	Soil	Moisture	Temperature	Survival	Source	
Hookworm larvae	Soil	Moist	Dense shade 15-33 ^o C	> 9 weeks	Augustine (1923)	
				< 11 weeks		
		Moist	Moderate shade 15-39 ^o C	> 6 weeks		
	< 7.5 weeks					
	Soil	Water- covered	Dense shade	> 20 days		
				< 36 days		
				Water- covered	Moderate shade	> 36 days
	< 43 days					
	Drying soil	Water covered	Sunlight	< 10 days		
				4-15%	Dense shade	> 4.5 weeks
						< 5 weeks
		2.6-7.8%	Moderate shade	> 10 days		
				< 15 days		
		Soil	1-5%	Sunlight	< 5 days	
> 10 days						
Moist	0 ^o C 16 ^o C		< 1 week			
			> 14 weeks < 17.5 weeks			
Moist	27 ^o C		> 9 weeks			
			< 11 weeks			
Moist	35 ^o C		< 3 weeks			
		Moist	40 ^o C	< 1 week		

Organism	Soil	Moisture	Temperature	Survival	Source
Hookworm ova	Heated soil fertilized with dilute night soil	Water-covered	15-27°C	9% survived after 2 weeks	Cort et al. (1926)
	Unheated soil fertilized with dilute night soil	Water-covered	15-27°C	3% survived after 2 weeks	
<u>Ascaris ova</u>	Sandy soil	Shade	25-36°C	31% dead after 54 days	Brown (1927)
	Sandy soil	Sun	24-38°C	99% dead after 15 days	
	Loam	Shade	25-36°C	3.5% dead after 21 days	
	Loam	Sun	24-38°C	4% dead after 21 days	
	Clay	Shade	25-36°C	2% dead after 21 days	
	Clay	Sun	24-38°C	12% dead after 21 days	
	Humus	Shade	25-36°C	1.5% dead after 22 days	
<u>Trichuris trichiura</u>	Sandy soil	Shade	25-36°C	8% dead after 35 days	
<u>Ascaris ova</u>	Clay	Shade	22-35°C	> 90 days	Beaver (1952)
	Sandy soil	Shade	22-35°C	< 90 days	
	Sandy soil	Sun	22-35°C	< 90 days	

Organism	Soil	Moisture	Temperature	Survival	Source
<u>Ascaris</u> ova	Soil irrigated with sewage	3-4%	?	< 2.5 years	Gudzhabidze (1959)
<u>Taenia hydatigena</u> ova	Soil	?	Summer (USSR)	> 6 months	Shepelev (1961)
<u>Strongyloides stercoralis</u> free-living adults	Soil	?	?	< 35 days	Shablovskaya (1963)
<u>Taenia saginata</u> oncosphere	Soil	?	Autumn winter Spring summer	< 7 months < 3.5 months < Several days	Babaeva (1966)
<u>Strongyloides stercoralis</u> larvae	Soil	?	?	< 18 days	Little and Gutierrez (1968)
<u>Trichuris trichiura</u> ova	Clay-flint soil	?	Depth in soil of 0-23 cm 23-70 cm (England)	> 18 months < 18 months	Burden <u>et al.</u> (1976)

APPENDIX VI

REPORTED SURVIVAL TIMES FOR EXCRETED ORGANISMS ON CROPS

Organism	Crop treatment	Temperature	Survival	Source
Enteroviruses	Tomatoes infected with viral suspension	3-8°C	90% reduction in 10 days	Bagdasaryan (1964)
		18-21°C	99% reduction in 10 days	
Polioviruses	Radishes	5-10°C	99% reduction in 20 days; some survive for over 2 months	
Enteroviruses	Root crops or leaf vegetables	?	< 60 days	Geldreich and Bordner (1971)
Poliovirus 1 (attenuated)	Tomatoes, indoors	22-25°C 37°C	< 12 days < 5 days	Kott and Fishelson (1974)
	Tomatoes, outdoors	?	< 1 day	
	Parsley	15-31°C	< 2 days	
Poliovirus 1	Spray irrigation with inoculated sewage effluent on lettuce and radishes	Summer and autumn Ohio, U.S.A.	99% reduction after 6 days, 100% after 36 days	Larkin, Tierney, and Sullivan (1976)
Poliovirus 1	Lettuce, radish tops, and radishes grown in soil flooded with inoculated sewage sludge or effluent	Summer, Ohio U.S.A.	< 23 days	Tierney, Sullivan, and Larkin (1977)
Coliforms	Tomatoes sprayed with fecal suspension or coliform suspension	?	> 1 month	Falk (1949)

Organism	Crop treatment	Temperature	Survival	Source		
<u>Pathogenic E. coli</u>	Vegetables irrigated with domestic sewage	?	< 3 weeks	Babov, Nadvornyi, and Keimakh (1967)		
Coliforms	Fodder	?	< 34 days	Geldreich and Bordner (1971)		
	Leaf vegetables	?	< 35 days			
<u>E. coli</u>	Slurry applied on grass	Sunny	< 8 days	Taylor and Burrows (1971)		
<u>S. typhi</u>	Leaves and stems of lettuces and radishes grown in soil sprinkled with fecal suspension after seeding	Indoors	< 25 days	Greel (1912)		
		Outdoors (Sheltered)	< 31 days			
		Outdoors (Unsheltered)	< 10 days			
<u>S. typhi</u>	Grown indoors in soil fertilized with fresh typhoid feces 2-3 days after planting			Melick (1917)		
		Lettuce	Winter		< 18 days	
		Radishes	Winter		< 53 days	
			Summer		< 35 days	
		Grown outdoors in soil previously fertilized with fresh typhoid feces				
			Radishes		21°C	< 24 days
		Grown outdoors in soil fertilized with fresh typhoid feces 4 days after planting				
			Lettuce		14°C	< 21 days
			Radishes		16°C	< 37 days

Organism	Crop treatment	Temperature	Survival	Source
<u>S. typhi</u>	Sliced sweetened strawberries inoculated with aqueous suspension	-18°C 4-5°C 22-27°C	< 6 months < 8 days < 6 hours	McCleskey and Christopher (1967)
	Uncut sweetened strawberries	-18°C	< 14 months	
<u>Salmonella</u> spp.	Vegetables	2-4°C Room temperature	< 10 weeks < 7 weeks	Falsenfield and Young (1945)
<u>S. cerro</u>	Sprayed tomatoes	?	< 7 days	Falk (1949)
<u>S. typhimurium</u>	Infected pasture	-4-22°C (shade)	< 22 weeks	Josland (1951)
		(sun)	< 24 weeks	
<u>Shigella</u>	Tomatoes sprayed with fecal suspension	Summer, U.S.A. dry, hot cool, wet	< 3 days > 4 days	Rudolfs, Falk, and Ragotzkie (1951: I)
<u>S. cerro</u>		Field conditions Laboratory conditions	< 5 days > 20 days	
<u>Salmonella</u> spp.	Fodder Root crops Leaf vegetables Berries Orchard crops	?	> 42 days < 53 days < 40 days < 5 days > 2 days	Geldreich and Bordner (1971)
<u>Shigella</u>	Fodder Leaf vegetables Orchard crops		< 2 days < 7 days < 6 days	
<u>S. dublin</u>	Slurry applied to pasture	Sunny	< 18 days	Taylor and Burrows (1971)

Organism	Crop treatment	Temperature	Survival	Source
<u>S. dublin</u>	Slurry on pasture	?	< 24 weeks	Findlay (1972)
<u>Salmonella</u>	Sludge on grass	?	< 72 weeks	Hess and Breer (1975)
<u>V. cholerae</u>	Vegetables	Room temperature Ice chest	< 1 week < 2 weeks	Felsenfeld (1956)
Bovine tubercle bacilli	Contaminated grass Initial conc. $10^6/m^2$ Initial conc. $10^7/m^2$ Initial conc. $10^9/m^2$	April-June (U.K.) April-June (U.K.) April-June (U.K.)	< 14 days < 28 days > 49 days	Maddock (1933)
<u>Entamoeba histolytica</u>	Tomatoes contaminated with suspension of cysts			Rudolfs, Falk, and Ragotzkie (1951: II)
	Wet soil	Warm, clear humid weather	< 42 hours	
	Dry soil	Warm, clear humid weather	< 18 hours	
	Lettuce Wet soil	Warm, clear humid weather	< 18 hours	
	Dry soil	Warm, clear humid weather	< 18 hours	
<u>Entamoeba histolytica</u>	Leaf vegetable	?	< 3 days	Geldreich and Bordner (1971)
<u>Taenia saginata</u> ova	Grass contaminated with 5 gravid segments	Denmark, June-July Feb.-July	< 58 days < 159 days	Jepsen and Roth (1949)

Organism	Crop treatment	Temperature	Survival	Source
<u>Ascaris ova</u>	Tomatoes and lettuce contaminated with a suspension of <u>Ascaris ova</u>	Hot, dry weather, New Jersey, U.S.A.	99% reduction in 19 days, 100% reduction in 4 weeks	Rudolfs, Falk, and Ragotzkie (1951: III)
<u>Taenia saginata ova</u>	Contaminated alfalfa hay	0-30°C	< 3 weeks	Lucker and Douvres (1960)
<u>Ascaris ova</u>	Leaf vegetables	?	< 35 days	Geldreich and Bordner (1971)

APPENDIX VII

REPORTED SURVIVAL TIMES FOR EXCRETED ORGANISMS IN COMPOSTING PLANTS

Organism	Process	Temperature	Time	Survival	Source
Bacteriophage	Sewage sludge composted with grass	40°C	6 days 14 days	Reduction: < 100% 100%	Krige (1964)
	Sewage sludge composted with refuse	38-60°C	6 days 14 days	< 100% 100%	
Poliovirus I	Aerobic composting of sewage sludge	60-70°C	5 days	Reduction: 100%	Wiley and Westerberg (1969)
Bacteriophage f2	Sewage sludge with woodchips in windrows: turned 4 times in 2-4 weeks and then stock-piled	Internal temperature of 50-70°C	2 weeks in windrows	Reduction: 99%	Burge and Cramer (1974) (quoted by Kawata, Cramer, and Burge, 1977)
	Same	Same	Subsequent 45 days in stockpile	100%	
	Turned only on 9th day in windrow	Same	2 weeks in windrow	90%	
	Same		Subsequent 70 days in windrow and stockpile	100%	
	Same		Mesophilic range due to rains	1 month in windrow	

Organism	Process	Temperature	Time	Survival	Source
Coliform	Composting	Max. temp. 55°C	?	Reduction: 99.9%	Kaibuchi (1959) (quoted by Wiley, 1962)
<u>E. coli</u>	Composting	Max. temp. 55°C	?	99.99%	
<u>E. coli</u>	Aerobic composting in range of materials, including different, mixtures of night soil, refuse, grass, sawdust, and stable manure in heaps or pits	Max. temp. 50->70°C	1-10 months	Final product contained < 10 ² -10 ⁶ <u>E. coli/g</u>	Krige (1964)
Coliform	Dewatered raw sewage sludge composted with woodchips in windrows and cured in stock-pile. Windrows turned daily. Depth:	Internal temp. 50-70°C	14 days in windrows		Burge and Cramer (1974) (quoted by Kawata, Cramer, and Burge, 1977)
	0-20 cm	Internal temp. 50-70°C	14 days in windrows	Reduction: 99%	
	20-40 cm	Internal temp. 50-70°C	14 days in windrows	99.99%	
	80-100 cm	Internal temp. 50-70°C	14 days in windrows	99.999%	

Organism	Process	Temperature	Time	Survival	Source
Coliform (continued)					Burge and Cramer (1974) (continued)
<u>E. coli</u>	0-20 cm	Internal temp. 50-70°C	14 days in windrows	99.9%	
	20-40 cm	Internal temp. 50-70°C	14 days in windrows	99.999%	
	80-100 cm	Internal temp. 50-70°C	14 days in windrows	100%	
Coliform	Aerobic composting of a mixture of 70-80% garbage and 20-30% night soil (by weight) in piles	Air temp. -5-33°C Pile temp. 0.5-64°C	105 days	9 log unit reduction	Chinese Medical Journal (1975)
<u>E. coli</u>	Refuse and sludge; moisture 60%, C/N 30, composted in a revolving drum	Max temp. > 55°C < 55°C	2 days 7 days	Reduction: 100% < 100%	Krogstad and Gudding (1975)

Organism	Process	Temperature	Time	Survival	Source
<u>E. coli</u>	aerobic and anaerobic composting of night soil with rubbish	Average air temp. 29°C Average pile temp. 40°C	?	Reduction: 99.99%	McGarry and Stainforth (1978)
<u>Salmonella</u> spp.	Composting refuse and sludge in undisturbed windrows	Max. temp. 55-70°C	50 days	Reduction: 100%	Knoll (1959) (quoted by Wiley, 1962)
<u>S. paratyphi</u> B	Refuse and sludge incubated, moisture 50%	50°C	2 days	100%	
<u>S. newport</u>	Aerobic composting of sewage sludge	60-76°C	25 hours	Reduction: 100%	Wiley and Westerberg (1969)
	Feces and garbage composted in windrows				Savage; MacMillan, and Chase (1972)
<u>S. typhi</u>	Turned 4 times per week	Max. temp. 55°C	40 days	Reduction: < 100%	
<u>S. paratyphi</u> C	Turned 20 times per week and supplemented with straw or old compost	68°C	14 days	100%	
<u>Salmonella</u> spp.	Sewage sludge composted with woodchips in windrows. After 2 weeks compost cured in stock-piles	Max. temp. 50-70°C	14 days	Reduction: 100%	Burge and Cramer (1974) (quoted by Kawata, Cramer, and Burger, 1977)

Organism	Process	Temperature	Time	Survival	Source	
<u>S.</u> <u>typhimurium</u>	Refuse and sludge Moisture 60%, C/N 30, composted in revolving <u>drum</u>			Reduction:	Krogstad and Gudding (1975)	
		65°C	2 days	100%		
		55°C	4 days	100%		
Hookworm ova and larvae (<u>Necator</u>)	Night soil and town refuse, turned once a week			Reduction:	Nicholls and Gunawardana (1939)	
		Center of heap	35-55°C	24 hours		100%
		Bottom of heap	35-65°C	24 hours		100%
		Outside of heap	35-60°C	24 hours		100%
<u>Ascaris</u> ova	Night soil and garbage composted aerobically	Max. 65°C	1 month	Reduction: 95%	Stone (1949)	
<u>Ascaris</u> ova	Aerobic composting in piles of feces, vegetable matter, ash, and soil. First turning after 5 days then every 10-15 days	Max. 65°C	5 days	Reduction: 85%	Scott (1952)	
			12 days	96%		
			22 days	99.7%		
			67 days	100%		

Organism	Process	Temperature	Time	Survival	Source
<u>Ascaris ova</u>	Bangalore method of composting night soil and refuse in pits (anaerobic)	Max 82°C	6-12 months	Reduction: < 100%	Bhaskaran <u>et al.</u> , (1957)
<u>Ascaris</u> , <u>Ancylostoma</u> and <u>Hymenolepis</u> ova	Composting of solid and liquid night soil mixed with garbage in heaps and covered with soil or sawdust	30-65°C	2-3 months	Reduction: 100%	Gudzhabidze and Lyubchenko (1959)
<u>Ascaris ova</u>	Sludge in heaps; moisture 45-60%	Internal temp. 55-70°C	2 months	Reduction: 85-100%	Murray (1960)
<u>Ascaris</u> and <u>Trichuris</u> ova	Compost manure heaps	< 35°C	60 days	Reduction: < 100%	Biziulevicius (1961)
<u>Ascaris ova</u>	Aerobic composting of sewage sludge	60-76°C	1 hour	Reduction: 100%	Wiley and Westerberg (1969)

Organism	Process	Temperature	Time	Survival	Source
<u>Ascaris ova</u>	Aerobic composting of a mixture of 70-80% garbage and 20-30% night soil (by weight) in piles	Air temp. -5-33°C Pile temp. 0.5-64°C	105 days	Reduction: 99-100%	Chinese Medical Journal (1975)
<u>Ascaris ova</u>	Aerobic and anaerobic composting of night soil with rubbish	Average pile temp. 40°C	28 days	Reduction: 0-6% of ova remained viable	McGarry and Stainforth (1978)

APPENDIX VIII

REPORTED SURVIVAL DATA FOR EXCRETED ORGANISMS IN IMHOFF TANKS AND SEPTIC TANKS

Organism	Process	Reduction or survival time	Source
Viruses	Imhoff tank	12-85% reduction	Kelly and Sanderson (1959)
<u>Coli aerogenes</u>	Imhoff tanks (series)	From reduction of 95% to increase of 230%	Heukelekian (1927)
<u>S. typhi</u>	Septic tanks	< 6 days survival	Flu (1921)
		Survival times	
<u>S. typhi</u>	Septic tank effluent	> 4 days; < 6 days	Kligler (1921)
	Septic tank pH=7.4-7.8	> 14 days; < 18 days	
	pH=8.4	> 3 days; < 5 days	
	pH=9	> 2 days; < 6 days	
<u>Sh. dysenteriae</u>	Septic tank pH= 8.6-8.8 pH= 9	> 3 days; < 6 days > 2 days; < 3 days	
<u>S. typhi</u>	Partially sterile effluent from septic tank		
	4 deg. C	> 11 days; < 18 days	
	20 deg. C	> 4 days; < 8 days	
	37 deg. C	> 1 day; < 2 days	
<u>Sh. dysenteriae</u>	Partially sterile effluent from septic tank		
	4 deg. C	> 8 days; < 11 days	
	20 deg. C	> 1 day; < 2 days	
	37 deg. C.	> 1 day; < 2 days	
<u>S. typhi</u>	Septic tank conditions	98% died within 4 days; a few survived for > 27 days	Green and Beard (1938) (quoted by Beard, 1937)
<u>S. typhi</u>	Imhoff tank	67% settled within 2 hrs.	Mom and Schaeffer (1940)

Organism	Process	Reduction or survival time	Source
<u>V. cholerae</u>	Septic tanks	Usually < 1 day survival	Flu (1921)
Tubercle bacilli	Imhoff tank	Some survived	Jensen (1954)
Tubercle bacilli	Septic tank	37% reduction	Heukelekian and Albanese (1956)
Tubercle bacilli	Septic tanks	Some survived	Greenberg and Kupka (1957)
<u>Schistosoma japonicum</u> ova	Model septic tank 15-24°C	Loss of viability 24% in 3 days 74% in 4-6 days 91% in 7-9 days 98.5% in 10-12 days 99.4% in 13-15 days 99.8% in 16-18 days No hatching ova were detected after 18 days.	Newton <u>et al.</u> (1948)
<u>Ascaris</u> ova	Septic tank	99.4% reduction	Bhaskaran <u>et al.</u> (1956)

APPENDIX IX

REPORTED SURVIVAL DATA FOR EXCRETED ORGANISMS IN PRIMARY SEDIMENTATION

Organism	Process	Reduction (from liquid effluent unless otherwise stated)	Source
Enteric viruses	Primary sedimentation	Average of 27%	Bloom <u>et al.</u> (1950)
Viruses	Primary sedimentation	Frequency of isolation from effluent stayed the same as in raw sewage	Kelly and Sanderson (1959)
Poliovirus 1	Sedimentation in laboratory, room temperature. 3 hours 6 hours 24 hours	0% 25-50% 30-60%	Clarke <u>et al.</u> (1961)
Enteroviruses	Primary sedimentation	7%	Kelly, Sanderson, and Neidl (1961)
Enteroviruses	Primary sedimentation	No removal was detected	Mack <u>et al.</u> (1962)
Coliphage f2	Primary sedimentation initial conc. 10 ⁶ pfu/ml	20-68%	Naparstek <u>et al.</u> (1976)
<u>B. coli</u> <u>B. aerogenes</u>	Imhoff tank	230% increase to 95% reduction	Heukelekian (1927)
<u>Coli aerogenes</u>	Settling, following aeration: 1 hour 2 hours 4 hours 5.5 hours	54% 81% 94% 96%	Ruchhoft (1934)
<u>E. coli</u>	Primary sedimentation	48%	Dunlop (1952)

Organism	Process	Reduction (from liquid effluent unless otherwise stated)	Source
Coliforms	Laboratory sedimentation at various times up to 24 hours	From growth of 205% to reduction of 60%	Clarke <u>et al.</u> (1961)
<u>S. typhi</u>	Settling, following aeration:		Ruchhoft (1934)
	1 hour	16%	
	2 hours	57%	
	4 hours	97%	
	5.5 hours	99.5%	
Tubercle bacilli	Primary sedimentation	Little effect	Kelly, Clark, and Coleman (1955)
Tubercle bacilli	Primary sedimentation	50%	Heukelekian and Albanese (1956)
<u>Ent. histolytica</u> cysts	Sedimentation tank 3 hours, 23-27 degrees C	A large number of cysts did not settle	Cram (1943)
<u>Ent. coli</u> cysts	Primary sedimentation (Denver treatment works)	48%	Dunlop (1952)
<u>Ascaris</u> ova	primary sedimentation (Kharkov treatment works)	66%	Vishnevskaya (1938)
<u>Ascaris</u> ova	Sedimentation tank, settling depth = 64 cm, 23-27 degrees C		Cram (1943)
	15 minutes	Few ova in upper layer	
	30 minutes	No ova in upper third	
Hookworm ova	2.5 hours	Few ova still in upper layer	

Organism	Process	Reduction (from liquid effluent unless otherwise stated)	Source
<u>Taenia saginata</u> ova	Laboratory sedimentation, 50-cm column of raw sewage	Reduction from top 45 cm	Newton et al. (1949)
	15 minutes	51%	
	30 minutes	65%	
	60 minutes	81%	
	120 minutes	98%	
<u>Ascaris</u> ova	Primary sedimentation (Denver treatment works)	50%	Dunlop (1952)
<u>Taenia saginata</u> ova	Sedimentation tanks in England	Ova found in sludge and effluent	Silverman and Griffiths (1955)
<u>Ascaris</u> ova	Sedimentation	1.5 hours	Bhaskaran et al. (1956)
		2 hours	
<u>Trichuris</u> ova		1.5 hours	60%
		2 hours	
Hookworm ova		1.5 hours	70%
		2 hours	
<u>Taenia saginata</u> ova	Sedimentation, 22 degrees C	2 hours	Liebmann (1964)
		3 hours	
<u>Ascaris</u> ova	Sedimentation	35-74%	Rowan (1964)
<u>Schistosoma mansoni</u>	Sedimentation	79-89%	
<u>Diphyllobothrium latum</u> ova	Flocculation with alum at 90-120 g/cu m and sedimentation for > 1 hour	100%	Döschl (1972) (quoted by Shepard, 1977)
Helminth ova	Sedimentation, 1.5 hours	90%	Knaack and Ritschel (1975)

APPENDIX X

REPORTED SURVIVAL DATA FOR EXCRETED ORGANISMS IN TRICKLING FILTERS

Organism	Process details	REDUCTION	SOURCE
Coxsackie A	Trickling filter	60%	Gilcreas and Kelly (1954)
Coliphage	Trickling filter	15%	(quoted by Kabler, 1959)
Coliphage	Trickling filter	57-73%	Ware and Mellon (1956) (quoted by Kabler, 1959)
Polio 1 Coxsackie B2	Trickling filter	Virus was isolated from effluent	Kelly, Winsser, and Winkelstein (1957)
Enteric viruses	Trickling filter	40% reduction, proportion of positive samples from effluent nearly as great as from raw sewage	Kelly and Sanderson (1959)
Enteroviruses and reoviruses	Tests on two sewage treatment plants incorporating primary sedimentation, primary trickling filters, humus tanks, secondary sedimentation, secondary trickling filters, and secondary humus tanks	No significant reduction at any stage in the treatment works	Malherbe and Strickland-Cholmley (1967)
Viruses	Trickling filter and humus tank	76%	Nupen (1975)

Organism	Process	Reduction (from liquid effluent unless otherwise stated)	Source
Bacteriophage f2	Trickling filter	6.3-40.4%	Sherman <u>et al.</u> (1975)
	Humus tank	16-51.1%	
	Trickling filter	1.3-13.1%	
	Humus tank	0-61.5%	
<u>B. coli</u> <u>B. aerogenes</u>	Trickling filter	39-99%	Heukelekian (1927)
Total bacteria	Trickling filter	70-85%	Metcalf and Eddy (1935) (Quoted by Kabler, 1959)
Total bacteria	Trickling filter	70-85%	Gainey (1939) (Quoted by Howe, 1976)
<u>Coli aerogenes</u>	Trickling filter + humus tank	96-97%	Allen <u>et al.</u> (1949)
<u>E. coli</u>	Trickling filter + humus tank	96-97%	
<u>Strep. faecalis</u>	Trickling filter + humus tank	95-97%	
<u>Coli aerogenes</u>	Trickling filter & humus tank (with higher loading rate than that above)	87-91%	
<u>E. coli</u>	Trickling filter & humus tank (with higher loading rate than that above)	86-88%	
<u>Strep. faecalis</u>	Trickling filter & humus tank (with higher loading rate than that above)	79-88%	
Coliform	Trickling filter	95%	Gilcreas and Kelly (1954) (quoted by Kabler, 1959)

Organism	Process	Reduction (from liquid effluent unless otherwise stated)	Source
Bacteria	High rate trickling filter, preceded and followed by sedimentation	80-95%	Imhoff and Fair (1956)
	Low rate trickling filter, preceded and followed by sedimentation	90-95%	
Coliform	Trickling filter	97%	Ware and Mellon (1956) (quoted by Kabler, 1959)
Coliform	Trickling filter	94-96%	McCoy (1957) (quoted by Kabler, 1959)
<u>E. coli</u>	Primary trickling filter	81.5%	Coetzee and Fourie (1965)
	Humus tank	35%	
	Secondary filter	84.3%	
	Humus tank	4.9%	
	Total plant	98.2%	
<u>Ps. aeruginosa</u>	Primary trickling filter	49.5%	increase
	Humus tank	56%	increase
	Secondary filter	21%	
	Humus tank	5.8%	
	Total plant	73.5%	increase
<u>Clostridium perfringens</u>	Primary trickling filter	73%	
	Humus tank	16%	increase
	Secondary filter	9%	increase
	Humus tank	76%	
	Total plant	92%	
Total bacteria	Trickling filter	90-95%	Klein (1966) (quoted by Howe, 1976)

Organism	Process	Reduction (from liquid effluent unless otherwise stated)	Source
<u>E. coli</u>	Trickling filter + humus tank	96%	Nupen (1975)
<u>Ps. aeruginosa</u>	Trickling filter + humus tank	92%	
<u>Cl. perfringens</u>	Trickling filter + humus tank	91%	
<u>Staphylococci</u>	Trickling filter + humus tank	81%	
<u>S. typhi</u>	Trickling filter plant (constant dosing), 23 degrees C	96-100%	Green and Beard (1938)
	Trickling filter plant (intermittent dosing), 24 degrees C	99.5-99.99%	
<u>S. paratyphi B</u>	Trickling filter	84-99%	McCoy (1957) (quoted by Kabler, 1959)
<u>S. typhi</u>	Primary trickling filter	36%	Coetzee and Fourie (1965)
	Humus tank	4.9%	
	Secondary filter	37% increase	
	Humus tank	66%	
	Total plant	71%	
Tubercle bacilli	Primary sedimentation plus trickling filter plus secondary sedimentation	99%	Pramer, Heukelekian, and Ragotzkie (1950)
Tubercle bacilli	Trickling filter	Found in effluent	Jensen (1954)
Tubercle bacilli	Trickling filter	Found in effluent	Kelly, Clark and Coleman (1955)
Tubercle bacilli	Primary sedimentation	48%	Heukelekian and Albanese (1956)
	Trickling filter	33%	
	Humus tank	18%	
	Total plant	72%	

Organism	Process	Reduction (from liquid effluent unless otherwise stated)	Source
<u>Ent. histolytica</u> cysts	Trickling filter at various loading rates	88-99%, no effect on viability, no correlation with BOD removal	Cram (1943)
<u>Ent. histolytica</u> cysts	Trickling filter plant	83%	Kott and Kott (1967)
<u>Ent. coli</u> cysts	Trickling filter plant	92%	
Helminth eggs	Trickling filter	18-26%	Vassilkova (1936)
<u>Ascaris</u> ova	Trickling filter	77%, viability not affected, eggs that remained on the filter continued to develop	Cram (1943)
Hookworm ova	Trickling filter	72%, viability not affected, eggs that remained on the filter continued to develop	
<u>Schistosoma japonicum</u> ova	Laboratory model trickling filter at various loading rates	At low loading rates 90-97% removal, whereas at high rates reduction fell to 33%. Further removal obtained in humus tank where hatching also occurred	Jones <u>et al.</u> (1947)
<u>Taenia saginata</u>	Trickling filter at various loading rates	62-70%	Newton, Bennett, and Figgot (1949)

Organism	Process	Reduction (from liquid effluent unless otherwise stated)	Source
<u>Ascaris</u> ova	Trickling filter pilot plant plus humus tank	99.8%	Bhaskaran <u>et al.</u> (1956)
Hookworm ova	Trickling filter pilot plant plus humus tank	100%	
<u>Ascaris</u> ova	Contact stone bed	83%	
Hookworm ova	Contact stone bed	72%	
<u>Ascaris</u> ova	Trickling filter	94.7-99.8%	Rowan (1964)
<u>Schistosoma</u>	Trickling filter	97.5% when detected in the effluent (6/7 samples were negative)	
<u>mansoni</u> ova			
<u>Parasite</u> ova	Trickling filter and humus tank	98%	Nupen (1975)

APPENDIX XI

REPORTED SURVIVAL DATA FOR EXCRETED ORGANISMS IN ACTIVATED SLUDGE

Organism	Process details	Reduction (in liquid effluent unless otherwise stated)	Source
Bacteriophages	Activated sludge plant effluent	66% in positive samples compared to raw sewage	Bloom et al. (1959)
		70% in positive samples compared to raw sewage	
Bacteriophages	Laboratory model activated	99%	Kelly and Sanderson (1959)
	Activated sludge plant with virus detected in influent	No virus detected in effluent	
Bacteriophage A9	Laboratory model activated sludge plant, continuous flow, 6-7 hours aeration time		Clarke et al. (1961)
	Initial conc. 10^4-10^5 pfu/ml	96-99.4%	
Bacteriophage 1	Initial conc. 10^4-10^5 pfu/ml	79-94%	
Poliovirus	Laboratory model activated sludge plant plus 30 minutes secondary settling	2 hours aeration	Kelly, Sanderson, and Neidl (1961)
		4 hours aeration	
		Reductions in positive samples	
Bacteriophage T2	2 hours aeration	45-64%	
		4 hours aeration	
Enteroviruses	Activated sludge plant plus secondary settling	A decrease in the proportion of positive samples from 25% (influent) to 2.6% (effluent); an increase in viral concentration of up to 336%	Mack et al. (1962)

Organism	Process details	Reduction (in liquid effluent unless otherwise stated)	Source
Poliovirus 1, 2 and 3 (vaccine)	Activated sludge plant, Calif. Initial conc. 20-276 pfu/ml	76-96% in concentration 46% in positive samples	England <u>et al.</u> (1967)
Adenovirus	Initial conc. 20-276 pfu/ml	25% in positive samples	
Reovirus	Initial conc. 20-276 pfu/ml	24% increase in positive samples	
Echovirus	Initial conc. 20-276 pfu/ml	55% in positive samples	
Coxsackievirus	Initial conc. 20-276 pfu/ml	97% in positive samples	
Viruses	Activated sludge	No removal	Pálfi, Simon, and Schulek (1970) (quoted by Berg, 1973)
Viruses	Activated sludge	< 70%	Berg (1973)
Enteric viruses	Pilot oxidation ditch, liquid retention: 20-88 hours solids retention: 1-256 days initial conc. 1225-7450 pfu/liter	92.5-100%	Rao <u>et al.</u> (1973)
Polioviruses	Activated sludge Initial conc. 10^{10} pfu/liter Mixed liquor 4 hours 8 hours 24 hours Supernatant 4 hours 8 hours 24 hours	 60-70% 80-90% 98-99.8% 96-99% 99.8-99.96% 99.99%	Malina <u>et al.</u> (1975)

Organism	Process details	Reduction (in liquid effluent unless otherwise stated)	Source
Coliphage f2	Step aeration activated sludge plant plus secondary sedimentation	0-33.3%	Naparstek et al. (1976)
Coliphage f2	3-stage activated sludge pilot plant Initial conc. 7×10^6 pfu/liter	99.97%	Safferman and Morris (1976)
Poliovirus 1	Laboratory activated sludge plant, 10 hours aeration at 15 degrees C	99-99.9%	Balluz, Jones, and Butler (1977)
Total counts	Activated sludge 5-6 hours aeration	0-56%	Courmant and Rochaix (1922) (quoted by Streeter, 1930)
Total counts	Activated sludge 5-6 hours aeration	95-98%	Bruns and Sierp (1927) (quoted by Streeter, 1930)
<u>Coli aerogenes</u>	12 liters of sewage plus 3 liters of settled activated sludge in a 20 liter jar at 22 degrees C Initial conc. 10^6 /ml 2 hours 4 hours After sedimentation, liquor 1 hour 2 hours 4 hours	54% 75% 88% 95% 98%	Ruchhoft (1934)

Organism	Process details	Reduction (in liquid effluent unless otherwise stated)	Source
<u>E. coli</u>	Aerated domestic sewage 2 days 4 days 6 days	An increase of 1.5 logs A decrease to just under initial conc. A decrease of less than 1 log from initial conc.	Heukelekian and Schulhoff (1935)
Total counts (20 degrees C)	"Bioflocculation" in aeration tanks at 18.8 degrees C	37%	Allen, Brooks, and Williams, (1949)
<u>Coli aerogenes</u>	"Bioflocculation" in aeration tanks at 18.8 degrees C	0.3%	
Fecal coliform	"Bioflocculation" in aeration tanks at 18.8 degrees C	20% to 120% increase	
<u>Strep. faecalis</u>	"Bioflocculation" in aeration tanks at 18.8 degrees C	17%	
Faecal coliform	Laboratory model activated sludge plant with 6-7 hours aeration	97%	Clarke et al. (1961)
Fecal streptococci	Laboratory model activated sludge plant with 6-7 hours aeration	96%	
Total bacteria	Activated sludge	90-98%	Howe (1976)
Coliforms	Activated sludge	91-98%	
Fecal coliforms	Activated sludge	99-99.9%	
<u>Strep. faecalis</u>	Activated sludge	99%	
<u>S. typhi</u>	Activated sludge 5-6 hours 24 hours	96% 99%	Bruns and Sierp (1927) (quoted by Streeter, 1930)

Organism	Process details	Reduction (in liquid effluent unless otherwise stated)	Source
<u>S. typhi</u>	Activated sludge		Pesch and Sauerborn (1929) (quoted by Streeter, 1930)
	5-6 hours	74%	
	24 hours	95%	
<u>S. typhi</u>	8 liters of sewage containing 15% activated sludge		Streeter (1930)
	6 hours	95.8%	
<u>S. paratyphi</u> B	8 liters of sewage containing 15% activated sludge		Streeter (1930)
	6 hours	97-98%	
<u>Sh. flexneri</u>	8 liters of sewage containing 15% activated sludge		Streeter (1930)
	6 hours	97-98%	
<u>S. paratyphi</u> B	Sewage mixed with 10% activated sludge		Streeter (1930)
	2 hours	52%	
	5 hours	64%	
	8 hours	66%	
	24 hours	96%	
<u>S. typhi</u>	12 liters of sewage plus 3 liters of settled activated sludge in a 20 liter jar at 22 deg. C initial conc.		Ruchhoft (1934)
	7.5x10 ⁵ /ml		
	1 hour	110% increase	
	2 hours	52%	
	3 hours	73%	
	4 hours	85%	
	5.5 hours	86%	
	After sedimentation, liquor		
	4 hours	95.6%	
	5.5 hours	99.2%	

Organism	Process details	Reduction (in liquid effluent unless otherwise stated)	Source	
<u>S. typhi</u>	Aerated domestic sewage		Heukelekian and Schulhoff (1935)	
	8 hours	90%		
	16 hours	99%		
		24 hours	99.9%	
	Activated sludge, 20 deg. C liquor			
	4-6 hours	45-51%		
	24 hours	99.95%-99.99%		
	Sludge			
	4-6 hours	114-310% increase		
	24 hours	99.6-99.9%		
<u>S. typhi</u>	Mixture			
	4-6 hours	163-364% increase		
	24 hours	99.55-99.89%		
<u>S. typhi</u>	Activated sludge		Green and Beard (1938)	
	6 hours aeration	91-99%		
	8 hours aeration	95-99.5%		
	24 hours aeration	99.9%		
<u>V. cholerae</u>	Activated sludge	98%	Bruns and Sierp (1927) (quoted by Streeter, 1930)	
	5-6 hours			
Tubercle bacilli	Laboratory model activated sludge liquor		Heukelekian and Albanese (1956)	
	1.5 hours	58%		
	3 hours	76%		
	6 hours	87%		
		24 hours	88%	
	Sludge			
	1.5 hours	21%		
	3 hours	2.9%		
	6 hours	25%		
	24 hours	54%		

Organism	Process details	Reduction (in liquid effluent unless otherwise stated)	Source
<u>Ent. histolytica</u> cysts	Laboratory model activated sludge, up to 72 hours aeration	No effect on viability	Cram (1943)
Hookworm ova and larvae	Laboratory model activated sludge, room temperature	Larvae developed and survived up to 5 days of aeration	Cram (1943)
<u>Ascaris</u> ova	Activated sludge, 20 degrees C	No effect on viability	
<u>Taenia saginata</u> ova	Activated sludge, up to 162 days aeration	No effect on viability	Newton et al. (1956)
<u>Ascaris</u> ova	Activated sludge Initial conc. 838 ova/liter	93%	Bhaskaran et al. (1956)
<u>Trichuris</u> ova	Initial conc. 7.3 ova/liter	92%	
Hookworm	Initial conc. 13 ova/liter	81%	
<u>Ascaris</u> ova	Activated sludge plant	98-99.2%	Rowan (1964)
Schistosome ova	Activated sludge plant	100%	

APPENDIX XII

REPORTED SURVIVAL DATA FOR EXCRETED

ORGANISMS IN SLUDGE DIGESTION PLANTS

Organism	Process	Temperature	Time	Survival	Source
Poliovirus 3	Primary sludge digestion (Sweden)	50°C	Up to 50-60 days	Viruses sometimes recovered	Lund (1971)
Reovirus Echovirus	Anaerobic sludge digestion (Budapest)	30°C	21 days	Viruses recovered from 38% of samples	Palfi (1972)
Poliovirus		33°C	40 days	Viruses recovered from 15% of samples	
				Average reduction: Bertucci et al. (1977)	
MS-2 coliphage	Anaerobic sludge digestion in a 250 ml conical flask	35°C	24 hours	89%	
		35°C	48 hours	99%	
Poliovirus	Anaerobic sludge digestion in a 250 ml conical flask	35°C	24 hours	95%	
		35°C	48 hours	99%	
Coxsackie A9	Anaerobic sludge digestion in a 250 ml conical flask	35°C	24 hours	98%	
		35°C	48 hours	99.7%	
Coxsackie B4	Anaerobic sludge digestion in a 250 ml conial flask	35°C	24 hours	91%	
		35°C	48 hours	99%	
Echovirus 12	Anaerobic sludge digestion in a 250 ml conical flask	35°C	24 hours	55%	
		35°C	48 hours	93%	
Coxsacki B3	Anaerobic sludge digestion in a pilot plant; average retention time 35 days	35°C	24 hours	99%	Eisenhardt et al. (1977)
		32°C	14 days	>99.999%	

Organism	Process	Temperature	Time	Survival	Source
<u>S. typhi</u>	Stored or digested sludge:				Ruchhoft (1934)
	Initial conc. 3×10^6 /ml	20-22°C	14 days	100% Reduction	
	Initial conc. 8×10^3 /ml	20-22°C	2 days	100% Reduction	
	Initial conc. 3×10^5 /ml	20-22°C	11 days	100% Reduction	
<u>S. typhi</u>	Laboratory replication of Imhoff tank conditions				Mom and Schaeffer (1940)
	Initial conc. 10^3 - 10^4 /ml	23°C	8 days	100% Reduction	
	Initial conc. 10^5 /ml	23°C	11 days	100% Reduction	
	Digested sludge from Imhoff tank	23°C	3 months	Some samples still positive	
<u>S. typhimurium</u>	Anaerobic digestion in bottles, initial conc. 5.7×10^7 /ml	26°C	45 days	Samples still positive	Stokes et al. (1945)
<u>S. typhi</u>	Laboratory anaerobic sludge digestion (fill and draw) single inoculum; theoretical retention time 6 days	?	Time since last inoculation	Reduction	McKinney Langley and Tomlinson (1958)
			12 hours	89%	
			48 hours	99.4%	
	Single inoculum, theoretical retention time 20 days	?	12 hours	99.5%	
			36 hours	99.9%	
	daily inocula theoretical retention time 6 days	?	24 hours	85%	
			Daily inocula, theoretical retention time 20 days	?	24 hours

Organism	Process	Temperature	Time	Survival	Source
<u>S. dublin</u>	Pig excrement stored anaerobically	?	1 month 3 month 330 days	Reduction: 90% 99% Some viable	Evans and Owens (1972) (quoted by Webber (1974))
<u>Salmonella</u>	Sludge digestion plant 33,000 gallons/day raw sludge contained <u>Salmonella</u> in 2/3 samples.	?	?	3/6 samples positive	Hales (1974)
<u>V. cholerae</u>	Anaerobic digestion of sludge liquor 1-5% s.s initial conc. $10^6 - 10^7$ /ml	?	14 days	4-7 log reduction (better survival with increased concentration of insuspended solids)	Webber (1974)
<u>V. cholerae</u> El Tor	initial conc. $10^5 - 10^6$ /ml	?	14 days	3-5 log reduction (better survival with increased s.s. concentration)	
<u>Tubercle bacilli</u>	Anaerobic sludge digestion digester in a sanitorium	?	35 days ?	Reduction: 85% 60% 3×10^3 /ml in final sludge	Heukelekian and Alabanese (1956)
<u>Entamoeba histolytica</u>	Anaerobic sludge digestion	20°C 30°C	12 days 10 days	< 100% < 100%	Cram (1943)
<u>Ascaris ova</u>	Anaerobic digestion in army camps in U.S.A.	?	?	9/23 samples positive	Wright; Cram and Nolan (1942)
<u>Trichuris ova</u>	Anaerobic digestion in army camps in U.S.A.	?	?	2/23 of samples positive	

Organism	Process	Temperature	Time	Survival	Source
				Reduction:	
<u>Ascaris</u>	Laboratory anaerobic	20°C	200 days	91%	Cram (1943)
<u>lumbricoides</u> ova	sludge digestion	30°C	160 days	95%	
		30°C	180 days	100%	
Hookworm ova and larvae	Laboratory anaerobic sludge digestion	20°C	64 days	< 100%	
	Laboratory anaerobic sludge digestion	30°C	41 days	< 100%	
				Reduction:	
<u>Ascaris</u> <u>lumbricoides</u> ova	Laboratory anaerobic sludge digestion	20°C	140 days	62%	Cram and Hicks (1944)
		30°C	140 days	91%	
		30°C	160 days	95%	
		30°C	> 160 days	100%	
	Secondary digestion of ova recovered from 53 days primary digestion at 30°C	30°C	87 days	81%	
		30°C	97 days	< 100%	
	recovered from 86 days primary digestion at greenhouse temperature	20°C	180 days	70%	
<u>Ascaris suum</u> ova	Laboratory anaerobic sludge digestion	20°C	371 days	100%	

Organism	Process	Temperature	Time	Survival	Source
<u>Schistoma japonicum</u>	anaerobic sludge digestion	6-18°C	9 weeks 10 weeks	reduction 100% 100%	Newton et al. (1948)
<u>Taenia saginata</u> ova	anaerobic sludge digestion in 1 gallon jars. Initial conc. 1.5 x 10 ⁵ /ml	24-29°C	203 days	reduction 85%	Newton et al. (1949)
<u>Ascaris ova</u>	sludge digestion (So. Africa) initial conc. 183-281/ml	?	?	163/ml in digested sludge	Keller and Hilde (1951)
<u>Ascaris ova</u>	sludge digestion in laboratory initial conc. 11-48/g	26-33°C	138 days	reduction 65%	Bhaskaran et al. (1956)
		37°C	150 days	75%	
		56°C	10 days	100%	
<u>Ascaris ova</u>	laboratory anaerobic digestion	25°C	45 days	reduction 85%	Kays et al. (1963)
		30°C	45 days	89%	
		38°C	45 days	92%	
	laboratory aerobic digestion	15°C	20 days	94%	
		30°C	20 days	55%	
		45°C	20 days	98%	
50°C	2 hours	98%			
<u>Taenia saginata</u> ova	anaerobic sludge digestion in experimental digester fresh sludge added daily	35°C	5 days	reduction 100%	Silverman and Guiver (1960)
<u>Ascaris ova</u>	laboratory anaerobic digestion	38°C	21 days	reduction 36%	Fitzgerald and Ashley (1977)

APPENDIX XIII

REPORTED SURVIVAL DATA FOR EXCRETED

ORGANISMS IN SLUDGE DEWATERING AND DRYING PLANTS

Organism	Process	Initial concentration	Temperature	Survival	Source
<u>S. paratyphi B.</u>	Raw sewage sludge on drying beds	2.5×10^7 /ml	Summer (England)	> 27 days < 41 days	Stokes <u>et al.</u> (1945)
<u>S. typhimurium</u>	Raw sewage sludge on drying beds	7.5×10^6 /ml	Winter Spring (England)	> 180 days	
<u>Salmonella spp.</u>	Sludge treated with ferric chloride + lime and dried by vacuum filtration	65% of samples positive	?	5% of samples positive	Kampelmacher and van Noorle Jansen (1972)
	Sludge treated with ferrous sulphate + lime and dried by vacuum filtration	59% of samples positive	?	5% of samples positive	
<u>Salmonella spp.</u>	Sludge drying; raw sludge had 2/3 samples positive; digested sludge had 3/6 samples positive	?	?	1/27 samples positive	Hales (1974)
Tubercle bacilli	Sludge on drying beds	27×10^5 /g	?	< 15 months	Jensen (1954)

Organism	Process	Initial concentration	Temperature	Survival	Source
Tubercle bacilli	Laboratory sludge drying	?	?	No substantial reduction in 22 days	Heukelekian and Albanese (1956)
<u>Ascaris ova</u>	Drying beds in different army camps in the U.S.A.	?	?	>62 days	Wright, Cram, and Nolan (1942)
<u>Trichuris ova</u>	Drying beds in different army camps in the U.S.A.	?	?	>4 days	
<u>Hymenolepis ova</u>	Drying beds in different army camps in the U.S.A.	?	?	>4 hours	
Hookworm ova and larvae	Drying digested sludge moisture fell to 10%	?	?	> 62 days	Cram (1943)
<u>Ascaris ova</u>	Drying digested sludge moisture >5%	?	Indoor up to 46°C	> 118 days	Cram and Hicks (1944)
	moisture <5%	?	Indoor up to 46°C	< 79 days	
	Moisture varied with weather	?	Outdoor 2-15°C	> 168 days	

Organism	Process	Initial concentration	Temperature	Survival	Source
<u>Schistosoma japonicum</u>	Sludge drying	?	15-24°C 29-32°C	< 22 days < 9 days	Newton, Figgat, and Weibel (1948)
<u>Ascaris ova</u>	Sludge drying	6-10/ml	?	> 5 weeks	Hogg (1950)
<u>Ascaris ova</u>	Sludge drying (South Africa)	604/ml	?	> 42 days	Keller and Hide (1951)
<u>Ascaris ova</u>	Laboratory sludge drying, initial moisture 85%, final moisture 3%	380/g	?	> 51 days	Bhaskaran <u>et al.</u> (1956)

APPENDIX XIV

REPORTED SURVIVAL DATA FOR EXCRETED ORGANISMS IN WASTE STABILIZATION PONDS

Organism	Details of ponds	Survival	Source
Enteric viruses	4 model ponds, 38 days' retention	No significant effect on viral content	Malherbe and Coetzee (1965)
Viruses	Pond fed by activated sludge effluent, 30 days' retention	20% of samples positive	England <i>et al.</i> (1967)(quoted Berg, 1973)
Viruses	Pond with 20 days' retention	Reduction 0-96%	Shuval (1970) (quoted by Berg, 1973)
Enteric viruses	3 ponds in series, 7 days' total retention	Reduction >90%	Arceivala <i>et al.</i> (1970)
Enteric viruses	1 pond, 7-25°C 2 ponds, 4-20°C 3 ponds, 2-26°C	4/4 of samples positive 4/4 of samples positive 12/13 samples positive	Slanetz <i>et al.</i> (1970)
Coliforms	2 ponds, 8-50 days' total retention air temperature 2-33°C	Reduction: 67-92%	Merz, Merrell, and Stone (1957)
<u>Escherichia coli</u>	2 anaerobic ponds, 3.5 days' retention	Reduction:	Parker (1962)
		9°C 67%	
		21°C 72%	
	Aerobic ponds, 10.5 days,	21°C 90%	
	Aerobic ponds, 20 days,	9°C 99%	
	Anaerobic ponds, 3.5 days,	21°C 86%	
	Anaerobic ponds, 7 days,	9°C 45%	
	Aerobic ponds, 17.5 days,	21°C 94%	
	Aerobic ponds, 37 days,	9°C 96%	
	8 ponds, 38.5 days,	21°C 88-99.99%	
	6 ponds, 30.5 days,	9 C 90-99.92%	

Organism	Details of ponds		Survival	Source	
<u>Streptococcus faecalis</u>	2 anaerobic ponds,	3.5 days	9°C	Reduction: 59 %	Parker (1962) (continued)
	Aerobic ponds,	10.5 days	21°C	98 %	
	Aerobic ponds,	20 days	9°C	99.8%	
	Anaerobic ponds,	3.5 days	21°C	87 %	
	Anaerobic ponds,	7 days	9°C	31 %	
	Aerobic ponds,	17.5 days	21°C	99.6%	
	Aerobic ponds	37 days	9°C	99 %	
	8 ponds,	38.5 days	21°C	90-99.99%	
6 ponds,	30.5 days	9°C	90-99.96%		
Coliforms	Single-cell pond, 230 kg BOD/ha/day (Ohio, U.S.A.)			Reduction: 92 %	Geldreich, Clark, and Huff (1964)
		Spring		89 %	
		Summer		99 %	
		Autumn		86 %	
Faecal coliform		Spring		95 %	
		Summer		98 %	
		Autumn		97 %	
		Winter		88 %	
Faecal streptococci		Spring		99.8%	
		Summer		99.2%	
		Autumn		97 %	
		Winter		97 %	
<u>E. coli</u>	1 pond	38 days (Zimbabwe)		Reduction: 80-99.9%	Hodgson (1964)
<u>E. coli</u>	2 ponds	35 days		Reduction: 99.98%	Coetzee and Fourie (1965)
				99.75%	
				99.91%	
<u>Ps aeruginosa</u> <u>Cl. perfringens</u>	4 maturation ponds, 10 days			98.7%	
<u>E. coli</u> <u>Ps. aeruginosa</u>				99.99%	
<u>E. coli</u>	1 pond	2 days		Reduction: 82 %	Marais (1966)
		8 days		94 %	
		20 days		97.5%	
		32 days		98.5%	
	3 ponds,	20 days		99.95%	
	4 ponds,	10 days		99.9%	

Organism	Details of ponds		Survival	Source
	3 ponds,	7 days, Nagpur (India)	Reduction:	Arceivala <u>et al.</u> (1970)
Coliforms	Initial conc. 10^6-10^7 /ml		99.93%	
<u>E. coli</u>	Initial conc. 10^6-10^8 /ml		99.69%	
Fecal streptococci	Initial conc. 10^5-10^6 /ml		99.95%	
Coliforms	Single ponds, 85-225 days (Georgia, U.S.A.)		Reduction: 90-99%	Little, Carroll, and Gentry (1970)
Fecal coliform			96-99.7 %	
Coliform	1 anaerobic pond connected to a series of other ponds		Reduction: 90-99.7 %	Perusho- thaman (1970)
Coliforms	1 pond,	22-25°C	Reduction 98.5 %	Slanetz <u>et al.</u> (1970)
Fecal coliform	1 pond,	22-25°C	98.4 %	
Fecal streptococci	1 pond,	22-25°C	99.5 %	
Coliforms	1 pond,	7-13°C	97.4 %	
Fecal coliform	1 pond,	7-13°C	97 %	
Fecal streptococci	1 pond,	7-13°C	90 %	
Coliforms	2 ponds	18-25°C	99.96%	
Coliforms	2 ponds,	4-20°C	99.7 %	
Fecal coliforms	2 ponds,	18-25°C	99.6 %	
Fecal coliforms	2 ponds,	4-20°C	99.5 %	
Fecal streptococci	2 ponds,	18-25°C	99.4 %	
Fecal streptococci	2 ponds,	4-20°C	99.88%	

Organism	Details of ponds		Survival	Source
Coliform	3 ponds	9-26°C	99.9999%	Slanetz <i>et al.</i> (Ccontinued)
Coliform	3 ponds,	1-14°C	99.93 %	
Fecal coliform	3 ponds,	9-26°C	99.9999%	
Fecal coliform	3 ponds,	1-14°C	99.86 %	
Fecal streptococci	3 ponds,	9-26°C	99.9999%	
Fecal streptococci	3 ponds,	1-14°C	99.8 %	
7 maturation ponds (Pretoria, South Africa)			Reduction:	Grabow., Middendorff, and Prozesky (1973)
Coliforms			91 %	
Drug resistant coliforms			78-91.5%	
<u>Salmonella typhi</u>	2 ponds,	35 days	Reduction:	Coetzee and Fourie (1970)
	4 maturation ponds,	10 days	99.5% 86.2%	
<u>Salmonella</u>	3 ponds,	7 days (Nagpur, India)	Reduction 100%	Arceivala <i>et al.</i> (1970)
<u>Salmonella</u>	1 pond,	85 days (Georgia, U.S.A.)	All samples positive	Little, Carroll, and Gentry (1970)
<u>Salmonella</u>	1 pond,	22-25°C	Proportion of positive samples:	
	1 pond,	7-13°C	2/5	Slanetz <i>et al.</i> (1970)
	2 ponds,	4-20°C	3/3	
	3 ponds,	16-26°C	4/10	
	3 ponds,	2-14°C	6/15	
	3 ponds,	4-20°C	2/17	
			10/14	
<u>Vibrio cholerae</u> El Tor	experimental pond, 5 days		Reduction:	Kott and Betzer (1972)
	<u>V. cholerae</u> suspended in bags in pond, 1 day		99.9-100% 100%	
Protozoal cysts	3 ponds, Initial conc. 635-1,705/liter	7 days (Nagpur, India)	Reduction: 100%	Arceivala <i>et al.</i> (1970)

Organism	Details of ponds	Survival	Source
<u>Ancylostoma duodenale</u>	Pond with up to 38 days' retention	Reduction: 100%	Hodgson (1964)
<u>Schistosoma mansoni</u>	Larvae, ova, or cysts of listed pathogens were detected in influent		
<u>Enterobius vermicularis</u>			
<u>Giardia lamblia</u>			
<u>Schistosoma mansoni</u> ova	Laboratory ponds, 20-29°C Anaerobic, 1 hour 2 hours 4 hours 8 hours	Reduction: 73% 88% 76% 100%	Kawata and Kruse (1966)
	Facultative, Aerobic, 8 hours 8 hours		
Miracidia	Anaerobic < 6 hours Aerobic <10 hours	100% 100%	
<u>Biomphalaria glabrata</u>	Anaerobic <42 days' normal life Aerobic	100%	
Helminth ova	4 ponds, 672 kg BOD/ha/day, initial conc. 28 ova/liter, temp. 22-34°C	Reduction: 100%	Koltypin (1969)
Helminth ova	3 ponds, 7 days (Nagpur, India) Initial conc. 135-447/liter	Reduction: 100%	Arceivala et al. (1970)
<u>Ancylostoma</u> ova	3 ponds, 6 days, 30-35°C	Reduction: 90%	Lakshminaryana and Abdulappa (1972)
<u>Ascaris</u>	3 ponds, 6 days, 30-35°C	100%	
<u>Trichuris</u>	3 ponds, 6 days, 30-35°C	100%	
<u>Hymenolepis</u>	3 ponds, 6 days, 30-35°C	100%	
<u>Enterobius</u>	3 ponds, 6 days, 30-35°C	100%	

REFERENCES

- Adams, A.P. and J.C. Spendlove, 1970. "Coliform Aerosols Emitted by Sewage Treatment Plants," Science, vol. 169, pp. 1218-20.
- Adenwagun, Z.A., 1975. The Ibadan Comfort Stations: an Experiment in Environmental Sanitation Health Education. Ibadan: African Regional Health Education Centre, Faculty of Medicine, University of Ibadan.
- Allen, L.A., E. Brooks, and I.L. Williams, 1949. "Effect of Treatment at the Sewage Works on the Numbers and Types of Bacteria in Sewage," Journal of Hygiene, vol. 47, pp. 303-19.
- _____, S. Pasley, and M.A.F. Pierce, 1952. "Some Factors Affecting the Viability of Fecal Bacteria in Water," Journal of General Microbiology, vol. 7, pp. 36-43.
- American Public Health Association, American Water Works Association and Water Pollution Control Federation, 1975. Standard Methods for the Examination of Water and Wastewater. 14th Ed. Washington, D.C.: American Public Health Association.
- Andre, D.A., H.H. Weisser, and G.W. Malaney, 1967. "Survival of Bacterial Enteric Pathogens in Farm Pond Water," Journal of the American Water Works Association, vol. 59, pp. 503-08.
- Arceivala, S.J., J.S.S. Lakshminarayana, S.R. Alagarsamy, and C.A. Sastry, 1970. "Health Aspects." In Waste Stabilization Ponds: Design, Construction, and Operation in India. Nagpur, India: Central Public Health Engineering Research Institute, pp. 87-95.
- Arfaa, F., G.H. Sahba, I. Farahmandian, and H. Jalali, 1977. "Evaluation of the Effect of Different Methods of Control of Soil-transmitted Helminths in Khuzestan, Southwest Iran," American Journal of Tropical Medicine and Hygiene, vol. 26, no. 2, pp. 230-33.
- Augustine, D.L., 1922. "Investigations on the Control of Hookworm Disease, 10: Experiments on the Length of Life of Infective Hookworm Larvae in Soils," American Journal of Hygiene, vol. 2, pp. 177-87.
- _____. 1923. "Investigations on the Control of Hookworm Disease, 23: Experiments on the Factors Determining the Length of Life of Infective Hookworm Larvae," American Journal of Hygiene, vol. 3, pp. 420-43.

- Azurin, J.C. and M. Alvero, 1974. "Field Evaluation of Environmental Sanitation Measures against Cholera," Bulletin of the World Health Organization, vol. 51, pp. 19-26.
- Babaeva, R.I., 1966. "Survival of Beef Tapeworm Oncospheres on the Soil Surface in Samarkand," Meditinskaya Parasitologia i Parazitarnye Bolezni, vol. 35, no. 5, pp. 557-59. [English Summary.]
- Babov, D.M., N.N. Nadvornyy, and A.S. Keimakh, 1967. "The Microflora of Vegetables and Other Crops Grown on Sewage Farms," Hygiene and Sanitation, vol. 32, pp. 273-75.
- Baermann, G., 1917. "About Ancylostomiasis, Its Conditions and Mode of Spread, and Ways of Combatting It," Geneeskundig Tijdschrift voor Nederlandsch-Indië, vol. 57, pp. 579-669.
- Bagdasaryan, G.A., 1964. "Survival of Viruses of the Enterovirus Group (Poliomyelitis, Echo, Coxsackie) in Soil and on Vegetables," Journal of Hygiene, Epidemiology, Microbiology, and Immunology, vol. 8, pp. 497-505.
- Balasegaram, M. and D.P. Burkitt, 1976. "Stool Characteristics and Western Diseases," Lancet, vol. 1, p. 152.
- Balluz, S.A., H.H. Jones, and M. Butler, 1977. "The Persistence of Poliovirus in Activated Sludge Treatment," Journal of Hygiene, vol. 78, pp. 165-73.
- Barbosa, F.S., R. Pinto, and O.A. Souza, 1971. "Control of Schistosomiasis in a Small North East Brazilian Community," Transactions of the Royal Society of Tropical Medicine and Hygiene, vol. 65, pp. 206-13.
- Beard, P.J., 1937. "The Survival of Typhoid in Nature." Journal of the American Water Works Association, vol. 30, no. 1, pp. 124-30.
- _____. 1940. "Longevity of Eberthella Typhosus in Various Soils," American Journal of Public Health, vol. 30, pp. 1077-82.
- Beaver, P.C., 1952. "Observations on the Epidemiology of Ascariasis in a Region of High Hookworm Endemicity," Journal of Parasitology, vol. 38, no. 5, pp. 445-53.

- Beaver, P.C. and G. Deschamps, 1949. "The Viability of E. histolytica Cysts in Soil," American Journal of Tropical Medicine, vol. 29, no. 2, pp. 189-91.
- Bécejac, S. and A. Lui, 1959. "The Influence of Temperature and Oxygen on the Development of Fasciola hepatica Eggs," Veterinarnski Arhiv, vol. 29, no. 90, pp. 293-301. [English Summary.]
- Benarde, M.A., 1973. "Land Disposal and Sewage Effluent: Appraisal of Health Effects of Pathogenic Organisms," Journal of the American Water Works Association, vol. 65, no. 6, pp. 432-40.
- Benenson, A.S., 1975. Control of Communicable Diseases in Man. Washington, D.C.: American Public Health Association.
- Bennett, E.R., K.D. Linstedt, and J.T. Felton, 1974. "Rural Home Wastewater Characteristics." In Proceedings of the National Home Sewage Disposal Symposium, Chicago, December 9-10, 1974. St. Joseph, Michigan: American Society of Agricultural Engineers, pp. 74-78.
- Berg, G., 1963. Virus Transmission by the Water Route. Washington, D.C.: U.S. Public Health Service, Bureau of State Services. Mimeographed.
- _____. 1973. "Removal of Viruses from Sewage, Effluents, and Waters, 1: A Review," Bulletin of the World Health Organization, vol. 49, pp. 451-60.
- Bergner-Rabinowitz, S., 1956. "The Survival of Coliforms, Streptococcus faecalis, and Salmonella tennessee in the Soil and Climate of Israel," Applied Microbiology, vol. 4, pp. 101-106.
- Bertucci, J.J., C. Lue-Hing, D. Zenz, and S.J. Sedita, 1977. "Inactivation of Viruses during Anaerobic Sludge Digestion," Journal of the Water Pollution Control Federation, vol. 49, no. 7, pp. 1642-51.
- Bhaskaran, T.R., M.A. Sampathkumaran, T.C. Sur, and I. Radhakrishnan, 1956. "Studies on the Effect of Sewage Treatment Processes on the Survival of Intestinal Parasites," Indian Journal of Medical Research, vol. 44, no. 1, pp. 163-80.

- Bhaskaran, T.R., B.K. Gosh Roy, M.A. Sampathkumaran, I. Radhakrishnan, and D.B. Mukherjee, 1957. "Studies on the Survival of Pathogens in Nightsoil Compost," Indian Journal of Agricultural Science, vol. 27, no. 1, pp. 91-102.
- Biziulevičius, S., 1961. "On the Viability of Ascaris lumbricoides and Trichuris trichiura Eggs in Compost Heaps," Acta Parasitologica Lithuanica, vol. 3, pp. 51-69. [English Summary.]
- Bloom, H.H., W.N. Mack, B.J. Krueger, and W.L. Mallmann, 1959. "Identification of Enteroviruses in Sewage," Journal of Infectious Diseases, vol. 105, pp. 61-68.
- Bockemühl, J. and A. Triemer, 1974. "Ecology and Epidemiology of Vibrio parahaemolyticus on the Coast of Togo," Bulletin of the World Health Organization, vol. 51, pp. 353-56.
- Boeck, W.C., 1921. "On the Longevity of Human Intestinal Protozoan Cyts," American Journal of Hygiene, vol. 1, pp. 527-39.
- Bradley, D.J., 1977. "Health Aspects of Water Supplies in Tropical Countries." In Water, Wastes, and Health in Hot Climates, ed. R.G.A. Feachem, M.G. McGarry, and D.D. Mara. London: John Wiley and Sons, pp. 3-17.
- Braga, A., 1964. "Research on the Survival of Salmonellae in Sludges of a Fertilizing Irrigation Plant," Igiene Moderna, vol. 57, pp. 635-47. [English Summary.]
- Brooke, M.M., A.W. Donaldson, and E. Brown, 1954. "An Amoebiasis Survey in a Veterans Administration Hospital, Chamblee, Georgia, with Comparison of Technics," American Journal of Tropical Medicine and Hygiene, vol. 3, no. 4, pp. 615-20.
- _____. G.R. Healy, P. Levy, R.L. Kaiser, and W.L. Bunch, 1963. "A Sample Survey of Selected Areas in and Near Little Rock, Arkansas, to Assess the Prevalence of Entamoeba histolytica," Bulletin of the World Health Organization, vol. 29, no. 6, pp. 813-22.
- Brown, H.W., 1927. "Studies on the Rate of Development and Viability of the Eggs of Ascaris lumbricoides and Trichuris trichiura under Field Conditions," Journal of Parasitology, vol. 14, no. 1, pp. 1-15.

Bruns, H. and F. Sierp, 1927. "Influence of Activated Sludge Sewage Treatment on Pathogenic Germs," Zeitschrift für Hygiene und Infektionskrankheiten, vol. 107, pp. 571-84.

Burden, D.J., A. Whitehead, E.A. Green, J.A. McFadzean, and R.J.S. Beer, 1976. "The Treatment of Soil Infested with the Human Whipworm, Trichuris trichiura," Journal of Hygiene, vol. 77, no. 3, pp. 377-82.

Burge, W.D. and W. N. Cramer, 1974. Destruction of Pathogens by Composting Sewage Sludge. Progress Report, Aug. 1, 1973 to Apr. 1, 1974, Joint Project: Maryland Environmental Services and Water Resources Management Administration, District of Columbia. Washington, D.C.

Burkitt, D.P., A.R.P. Walker, and N.S. Painter, 1972. "Effect of Dietary Fibre on Stools and Transit Times, and Its Role in the Causation of Disease," Lancet, vol. 11, pp. 1408-12.

_____. 1974. "Dietary Fibre and Disease," Journal of the American Medical Association, vol. 229, pp. 1068-74.

Cabelli, V.J., H. Kennedy, and M.A. Levin, 1976. "Pseudomonas aeruginosa--Fecal Coliform Relationships in Estuarine and Fresh Recreational Waters," Journal of the Water Pollution Control Federation, vol. 48, no. 2, pp. 367-76.

Chambers, C.W., 1971. "Chlorination for Control of Bacteria and Viruses in Treatment Plant Effluents," Journal of the Water Pollution Control Federation, vol. 43, no. 2, pp. 228-41.

Chambers, R., 1974. Managing Rural Development: Ideas and Experiences from East Africa. Uppsala: The Scandinavian Institute of African Studies.

Chandler, A.C., 1953. "An Evaluation of the Effects, after Two Years, of Sanitary Improvements in an Egyptian Village," Journal of the Egyptian Medical Association, vol. 36, pp. 357-67.

_____. 1954. "A Comparison of Helminthic and Protozoan Infections in Two Egyptian Villages Two Years after the Installation of Sanitary Improvements in One of Them," American Journal of Tropical Medicine and Hygiene, vol. 3, no. 1, pp. 59-73.

- Chang, S.L., 1943. "Studies on Entamoeba histolytica, II: Observations Concerning Encystation, Maturation and Excystation of E. histolytica and on the Longevity of Culture-induced Cysts in Various Fluids and at Different Temperatures," Journal of Infectious Diseases, vol. 72, pp. 232-41.
- Chefranova, Y.A., 1964. "On the Epidemiology of Diphyllbothriasis in the Regions of the Extreme North." In Problems in Medical Parasitology and Prophylaxis of Infections, ed. S.D. Moshkovski, Moscow: Martsinovski Institute of Medical Parasitology and Tropical Medicine, pp. 495-500. [English Summary.]
- Chinery, W.A., 1969. "A Survey of Mosquito Breeding in Accra, Ghana, during a Two-year Period of Larval Mosquito Control," Ghana Medical Journal, vol. 8, no. 4, pp. 266-74.
- Clarke, N.A., G. Berg, P.W. Kabler, and S.L. Chang, 1962. "Human Enteric Viruses in Water: Source, Survival and Removability," In Advances in Water Pollution Research, pp. 523-541. Proceedings of the First International Conference of Water Pollution Research, London.
- _____ and S.L. Chang, 1959. "Enteric Viruses in Water," Journal of the American Water Works Association, vol. 51, pp. 1299-1317.
- _____ and P.W. Kabler, 1964. "Human Enteric Viruses in Sewage," Health Laboratory Science, vol. 1, no. 1, pp. 44-50.
- _____, R.E. Stevenson, S.L. Chang, and P.W. Kabler, 1961. "Removal of Enteric Viruses from Sewage by Activated Sludge Treatment," American Journal of Public Health, vol. 51, no. 8, pp. 1118-29.
- _____, R.E. Stevenson, and P.W. Kabler, 1956. "Survival of Coxsackie Virus in Water and Sewage," Journal of the American Water Works Association, vol. 48, pp. 677-82.
- Coetzee, O.J. and N.A. Fourie, 1965. "The Efficiency of Conventional Sewage Purification Works, Stabilization Ponds and Maturation Ponds with Respect to the Survival of Pathogenic Bacteria and Indicator Organisms," Journal of the Institute of Sewage Purification, vol. 3, pp. 210-15.
- Cohen, J., T. Schwartz, R. Klasmer, D. Pridan, H. Ghalayini, and A.M. Davies, 1971. "Epidemiological Aspects of Cholera El Tor Outbreak in a Nonendemic Area," Lancet, vol. ii, pp. 86-89.

Connell, A. and C.L. Smith, 1974. "The Effect of Dietary Fibre on Transit Times." In Proceedings of the Fourth International Symposium on Gastrointestinal Motility, Banff, Alberta, 1973, ed. E.E. Daniel, et al. Vancouver: Mitchell Press, pp. 365-68.

Cornwall, D.A., J. Zoltek, C.D. Patrinely, T. des Furman, and J.I. Kim, 1977. "Nutrient Removal by Water Hyacinth," Journal of the Water Pollution Control Federation, vol. 49, pp. 57-65.

Cort, W.W., J.B. Grant, N.R. Stoll, and H.W. Tseng, 1926. "Rice Cultivation and Hookworm Infestation," American Journal of Hygiene, Monograph Series, no. 7, pp. 223-36.

_____, G.F. Otto, and L.A. Spindler, 1930. Investigations on Ascaris lumbricoides and the Associated Intestinal Helminths of Man in Southwestern Virginia," American Journal of Hygiene, vol. 11, no. 1, pp. 1-55.

_____, L. Schapiro, and N.R. Stoll, 1929. "A Study of Reinfection after Treatment with Hookworm and Ascaris in Two Villages in Panama," American Journal of Hygiene, vol. 10, no. 3, pp. 614-25.

Cotteral, J.A. and D.P. Norris, 1969. "Septic Tank Systems," Journal of the Sanitary Engineering Division, American Society of Civil Engineers, vol. 95, pp. 715-46.

Courmont, P. and A. Rochaix, 1922. "Research on the Bacterial Purification of Sewage by the Activated Sludge Process," Revue d'Hygiène, vol. 44, pp. 907-19.

Cram, E.B., 1943. "The Effect of Various Treatment Processes on the Survival of Helminth Ova and Protozoan Cysts in Sewage," Sewage Works Journal, vol. 15, no. 6, pp. 1119-38.

_____, and D.O. Hicks, 1944. "The Effect of Sludge Digestion Drying and Supplemental Treatment on Eggs of Ascaris lumbricoides," Proceedings of the Helminthological Society of Washington, vol. 11, no. 1, pp. 1-9.

Cranston, D. and D.P. Burkitt, 1975. "Diet, Bowel Behaviour and Disease," Lancet, vol. ii, p. 37.

- Creel, R.H., 1912. "Vegetables as a Possible Factor in the Dissemination of Typhoid Fever," Public Health Reports, vol. 27, no. 6, pp. 187-95.
- Crofts, T.J., 1975. "Bowel-Transit Times and Diet," Lancet, vol. 1, p. 801.
- Curtis, D.M.E., 1978. "Values of Latrine Users and Administrators." In Sanitation in Developing Countries, ed. A. Pacey, Chichester: John Wiley and Sons, pp. 170-76.
- Damgaard-Larsen, S., K.O. Jensen, E. Lund, and B. Nissen, 1977. "Survival and Movement of Enterovirus in Connection with Land Disposal of Sludges," Water Research, vol. 11, pp. 503-08.
- Dazzo, F., P. Smith, and D. Hubbell, 1973. "The Influence of Manure Slurry Irrigation on the Survival of Fecal Organisms in Scranton Fine Sand," Journal of Environmental Quality, vol. 2, no. 4, pp. 470-73.
- Delage, B., 1961. "Survival of Salmonellae in Soil," Archives de l'Institut Pasteur du Maroc, vol. 6, pp. 139-42.
- Demster, R., 1894. "The Influence of Different Kinds of Soil on the Comma and Typhoid Organisms," British Medical Journal, vol. 1, pp. 1126-27.
- Department of the Environment (U.K.) 1977. Sewage Sludge Disposal Data and Technical Notes. Water Engineering I, Research and Development Division, Technical Note no. 6. London: Her Majesty's Stationery Office.
- Department of Environmental Health, Institute of Health, Chinese Academy of Medical Sciences, Peking. 1975. "Sanitary Effects of Urban Garbage and Nightsoil Composting," Chinese Medical Journal, vol. 1, no. 6, pp. 407-12.
- Department of Health and Social Security. 1969. The Bacteriological Examination of Water Supplies. Reports on Public Health and Medical Subjects, no. 71, 4th ed. London: Her Majesty's Stationery Office.
- Dickson, D., 1974. Alternative Technology and the Politics of Technical Change. London: Fontana/Collins.

- Döschl, R., 1972. "Studies on the Sedimentation of Eggs of the Fish Tapeworm Diphyllobothrium latum Using the Flocculating Agent Aluminium Sulphate," Inaugural dissertation, Munich: Ludwig-Maximilians-Universität.
- Douglas, M., 1966. Purity and Danger. London: Routledge and Kegan Paul.
- Drozdov, V.N., 1962. "Survival of Eggs of Opisthorchis felineus under Different External Conditions," Meditinskaya Parasitologia i Parazitarnye Bolezni, vol. 31, no. 3, pp. 323-26. [English Summary.]
- Duboise, S.M., B.E. Moore, and B.P. Sagik, 1976. "Poliovirus Survival and Movement in a Sandy Forest Soil," Applied and Environmental Microbiology, vol. 31, pp. 536-43.
- Dunlop, S.G. 1952. "Irrigation of Truck Crops with Sewage-contaminated Water," The Sanitarian, vol. 15, pp. 107-10.
- Eisenhardt, A., E. Lund, and B. Nissen, 1977. "The Effect of Sludge Digestion on Virus Infectivity," Water Research, vol. 11, pp. 579-81.
- England, B., R.E. Leach, B. Adame, and R. Shiosaki, 1967. "Virologic Assessment of Sewage Treatment at Santee, California." In Transmission of Viruses by the Water Route, ed. G. Berg, New York: John Wiley and Sons, pp. 401-17.
- Enigk, K., R. Thaer, A. Dey-Harza, and R. Ahlers, 1975. "Survival of Resistant External Stages of Parasites during Fermentation in Liquid Cattle Manure at Raised Temperatures," Zentralblatt für Veterinärmedizin; Riehe B, vol. 22, no. 8, pp. 687-702.
- Essex, H.E. and T.B. Magath, 1931. "A Comparison of the Viability of Ova of the Broad Fish Tapeworm, Diphyllobothrium latum, from Man and Dogs: Its Bearing on the Spread of Infestation with This Parasite," American Journal of Hygiene, vol. 14, no. 3, pp. 698-704.
- Evans, M.R. and J.D. Owens, 1972. "Factors Affecting the Concentrations of Fecal Bacteria in Land-drainage Water," Journal of General Microbiology, vol. 71, pp. 477-85.

Evison, L.M. and A. James, 1977. "Microbiological Criteria for Tropical Water Quality. In Water, Wastes, and Health in Hot Climates, ed. R.G.A. Feachem, M.G. McGarry, and D.D. Mara, London: John Wiley and Sons, pp. 30-51.

_____ and S. Morgan, 1978. "Further Studies on Bifidobacteria as Indicators of Fecal Pollution in Water." Paper presented to the International Association for Water Pollution Research, Stockholm, June 1978. In Progress in Water Technology (1979).

Eyles, D.E., F.E. Jones, and C.S. Smith, 1953. "A Study of Entamoeba histolytica and Other Intestinal Parasites in a Rural West Tennessee Community," American Journal of Tropical Medicine and Hygiene, vol. 2, no. 2, pp. 173-90.

Falk, L.L., 1949. "Bacterial Contamination of Tomatoes Grown in Polluted Soil," American Journal of Public Health, vol. 39, pp. 1338-42.

Fattal, B., E. Katzenelson, T. Hostovski, and H.I. Shuval, 1976. "Viral Contamination of Vegetables Drip-irrigated with Wastewater." In Final Report on the Health Problems Originating in the Use of Wastewater for Vegetable Irrigation in the Experimental Plot of Kibutz Eilat--1974/ 1975. Jerusalem: The Hebrew University of Jerusalem.

Faust, E.C. and O. Khaw, 1927. "Studies on Clonorchis sinensis (Cobbold)," American Journal of Hygiene, Monograph Series, no. 8.

Feachem, R.G.A., 1975. "An Improved Role for Fecal Coliform to Fecal Streptococci Ratios in the Differentiation Between Human and Nonhuman Pollution Sources," Water Research, vol. 9, no. 6, pp. 689-90.

_____ 1977. "Environmental Health Engineering as Human Ecology: An Example from New Guinea," In Subsistence and Survival--Rural Ecology in the Pacific, ed. T. Bayliss-Smith and R.G.A. Feachem, London: Academic Press, pp. 129-82.

_____ E. Burns, A. Cairncross, A. Cronin, P. Cross, D. Curtis, M. Khalid Khan, D. Lamb, and H. Southall, 1978a. Water, Health and Development: An Interdisciplinary Evaluation. London: Tri-Med Books, Ltd.

_____ and A. Cairncross, 1978. "Small Excreta Disposal Systems," Ross Institute of Tropical Hygiene Bulletin, No. 8.

Feachem, R.G.A., M.G. McGarry, and D.D. Mara, 1977. Water, Wastes, and Health in Hot Climates. London: John Wiley and Sons.

_____, D.D. Mara, and K.O. Iwugo, 1980. Appropriate Technology for Water Supply and Sanitation, vol. 7, Alternative Sanitation Technologies for Urban Areas in Africa. Washington: World Bank, Transportation, Water and Telecommunications Department.

_____, D.J. Bradley, H. Garelick, and D.D. Mara. Forthcoming. Sanitation and Disease: Health Aspects of Excreta and Wastewater Management. World Bank Studies in Water Supply and Sanitation, no. 3. Baltimore: Johns Hopkins University Press.

Federov, V.G. 1956. "Studies of the Influence of Oxygen, Low Temperatures, and Chloramine on the Development and Vitality of Diphyllobothrium latum (Cestoidea)," Zoologicheski Zhurnal, vol. 35, no. 5, pp. 655-56.

Felsenfeld, O. 1965. "Notes on Food, Beverages and Fomites Contaminated with V. cholerae," Bulletin of the World Health Organization, vol. 33, pp. 725-34.

_____, and V.M. Young, 1945. "The Viability of Salmonella on Artificially Contaminated Vegetables," Poultry Science, vol. 24, p. 353.

Findlay, C.R. 1972. "The Persistence of Salmonella dublin in Slurry Tanks and on Pasture," Veterinary Records, vol. 91, pp. 233-35.

Firth, R.H. and W.H. Horrocks, 1902. "An Inquiry into the Influence of Soil, Fabrics, and Flies in the Dissemination of Enteric Infection," British Medical Journal, vol. 2, pp. 936-43.

Fitzgerald, P.R. and R.F. Ashley, 1977. "Differential Survival of Ascaris Ova in Wastewater Sludge," Journal of the Water Pollution Control Federation, vol. 49, no. 7, pp. 1722-24.

Flu, P.C., 1921. "Investigations of the Duration of Life of Cholera Vibriones and Typhoid Bacteria in Septic Tanks at Batavia," Mededeelingen van der Burgerlijken Geneeskundigen dienst in Nederlandschindie, vol. 3, pp. 289-97.

Food and Agricultural Organization. 1975. "Organic Materials as Fertilizers," Soils Bulletin, vol. 27.

Freeman, C. and L. Pyle, 1977. Methane Generation by Anaerobic Fermentation: An Annotated Bibliography. London: Intermediate Technology Development Group.

Fuchs, H-M, S. Dorfman, and M.H. Floch, 1976. "The Effect of Dietary Fibre Supplementation in Man, II: Alteration in Fecal Physiology and Bacterial Flora," American Journal of Clinical Nutrition, vol. 29, pp. 1443-47.

Gainey, D.L. 1939. Microbiology of Water and Sewage. Minneapolis: Burgess Publishing Co.

Galvagno, O. and A. Calderini, 1908. "Survival and Virulence of Typhoid Bacilli in Pit Latrines, Tanks, and in Soil," Zeitschrift für Hygiene und Infektionskrankheiten, vol. 61, pp. 185-208.

Gameson, A.L.H. (ed.). 1975. Proceedings of a Conference on Discharge of Sewage from Sea Outfalls, London, Aug. 27 - Sept. 2, 1974. London: Pergamon Press.

Geldreich, E.E. 1966. "Sanitary Significance of Fecal Coliforms in the Environment," Water Pollution Control Research Series, no. WP-20-3. Washington, D.C.: U.S. Department of the Interior.

_____ and R.H. Bordner, 1971. "Fecal Contamination of Fruits and Vegetables during Cultivation and Processing for Market: A Review," Journal of Milk and Food Technology, vol. 34, pp. 184-95.

_____, H.F. Clark and C.B. Huff, 1964. "A Study of Pollution Indicators in a Waste Stabilization Pond," Journal of the Water Pollution Control Federation, vol. 36, no. 11, pp. 1372-79.

Gerba, C.P., C. Wallis, and J.L. Melnick, 1975. "Fate of Wastewater Bacteria and Viruses in Soil," Journal of the Irrigation and Drainage Division, American Society of Civil Engineers, vol. 101, pp. 157-74.

- Glicreas, F.W. and S.M. Kelly, 1954. "Significance of the Coliform Test in Relation to Intestinal Virus Pollution of Water," Journal of the New England Water Works Association, vol. 68, pp. 255-77.
- Gildemeister, E. and K. Baerthlein, 1915. "A Contribution to the Study of Cholera," Münchener Medizinische Wochenschrift, vol. 62, pp. 705-08.
- Goldsmith, H.S. and D.P. Burkitt, 1975. "Stool Characteristics of Black and White Americans," Lancet, vol. 11, p. 407.
- Gordon, J.E., M. Behar, N.S. Scrimshaw, M.A. Guzman, and W. Ascoli, 1964. "Acute Diarrheal Disease in Less Developed Countries," Bulletin of the World Health Organization, vol. 31, pp. 1-28.
- Gotaas, H.B. 1956. "Composting: Sanitary Disposal and Reclamation of Organic Wastes," World Health Organization, Monograph Series, no. 31.
- Goy, J.A.E., M.A. Eastwood, W.D. Mitchell, J.L. Pritchard, and A.N. Smith, 1976. "Fecal Characteristics Contrasted in the Irritable Bowel Syndrome and Diverticular Disease," American Journal of Clinical Nutrition, vol. 29, pp. 1480-84.
- Goyder, C. 1978. "Voluntary and Government Sanitation Programmes." In Sanitation in Developing Countries, ed. A. Pacey, Chichester: John Wiley and Sons, p. 162.
- Grabow, W.O.K., I.G. Middendorff, and O.W. Prozesky, 1973. "Survival in Maturation Ponds of Coliform Bacteria with Transferable Drug Resistance," Water Research, vol. 7, pp. 1589-97.
- Grancher, J. and E. Deschamps, 1889. "Research on Typhoid Bacillae in Soil," Archives de Médecine Expérimentale et d'Anatomie Pathologique, vol. 1, pp. 33-44.
- Gray, E.A., 1975. "Survival of Escherichia coli in Stream Water in Relation to Carbon Dioxide and Plant Photosynthesis," Journal of Applied Bacteriology, vol. 39, pp. 47-54.
- Gray, H. and M.L. Tainter, 1941. "Colloid Laxatives Available for Clinical Use," American Journal of Digestive Disorders, vol. 8, pp. 130-39.

- Green, C.E. and P.J. Beard, 1938. "Survival of E. typhi in Sewage Treatment Plant Processes," American Journal of Public Health, vol. 28, pp. 762-70.
- Green, S.K., M.N. Schroth, J.J. Cho, S.D. Kominos, and V.B. Vitanza-Jack, 1975. "Agricultural Plants and Soil as a Reservoir for Pseudomonas aeruginosa," Applied Microbiology, vol. 28, no. 6, pp. 987-91.
- Greenberg, A.E. and E. Kupka, 1957. "Tuberculosis Transmission by Waste Waters--A Review," Sewage and Industrial Wastes, vol. 29, no. 5, pp. 524-37.
- Greenberg, B., 1971. Flies and Disease, vol. I, Ecology, Classification and Biotic Associations. Princeton, N.J.: Princeton University Press.
- _____. 1973. Flies and Disease, vol. II, Biology and Disease Transmission. Princeton, N.J.: Princeton University Press.
- Greenberg, C.J., 1976. "Studies on the Fibre in Human Diets." Ph.D dissertation. Cambridge University.
- Greig, E.D.W., 1914. "On the Vitality of the Cholera Vibrio Outside the Human Body," Indian Journal of Medical Research, vol. 1, pp. 481-504.
- Gudzhahidze, S.I., 1959. "Experimental Observations on the Development and Survival of Ascaris lumbricoides Eggs in the Soil of Fields Fertilized with Sewage," Meditinskaya Parasitologia i Parazitarnye Bolezni, vol. 28, no. 5, pp. 578-83. [English Summary.]
- _____ and S.D. Lyubchenko, 1959. "Control of Ascariasis and Ancylostomiasis by Composting of Organic Waste Material," Meditinskaya Parasitologia i Parazitarnye Bolezni, vol. 28, no. 5, pp. 576-78. [English Summary.]
- Gurak, R.S., 1978. Final Report on the Alternative Waste Disposal Methods Project in Tanzania, East Africa: Chemical, Microbiological and Parasitological Results. Ottawa: International Development Research Centre.
- Hales, D., 1974. "Salmonellae in Dried Sewage Sludge," Environmental Health, vol. 82, no. 11, pp. 213-15.

- Hamdy, E.I., 1970. "Urine as an Ascaris lumbricoides Ovicide," Journal of the Egyptian Medical Association, vol. 53, nos. 3-4, pp. 261-64.
- Hanes, N.B., W.B. Sarles, and G.A. Rohlich, 1964. "Dissolved Oxygen and Survival of Coliform Organisms and Enterococci," Journal of the American Water Works Association, vol. 56, no. 4, pp. 441-46.
- Hess, E. and C. Breer, 1975. "Epidemiology of Salmonellae and Fertilizing of Grassland with Sewage Sludge," Zentralblatt für Bakteriologie, Parasitenkunde, Infektionskrankheiten und Hygiene, I Abteilung Originale, Reihe B, vol. 161, no. 1, pp. 54-60. [English Summary.]
- Heukelekian, H., 1927. "The Fate of B. coli and B. aerogenes in Sewage Purification," Journal of Bacteriology, vol. 14, pp. 55-67.
- _____ and M. Albanese, 1956. "Enumeration and Survival of Human Tubercle Bacilli in Polluted Waters, II: Effect of Sewage Treatment and Natural Purification," Sewage and Industrial Wastes, vol. 28, no. 9, pp. 1094-1102.
- _____ and H.B. Schulhoff, 1935. "Studies on the Survival of B. typhosus in Surface Waters and Sewage," Bulletin of the New Jersey Agricultural Experiment Station, vol. 589, pp. 1-31.
- Hickey, J.L.S. and P.C. Reist, 1975. "Health Significance of Airborne Microorganisms from Wastewater Treatment Processes, Part I: Summary of Results," Journal of the Water Pollution Control Federation, vol. 47, pp. 2741-57.
- Hindhaugh, G.M.A., 1973. "Nightsoil Treatment," The Consulting Engineer, vol. 37, no. 9, pp. 47, 49.
- Hodgson, H.T. 1964. "Stabilization Ponds for a Small African Urban Area," Journal of the Water Pollution Control Federation, vol. 36, no. 1, pp. 51-66.
- Hogg, E.S. 1950. "A Preliminary Study of Ova and Cysts in Cydna Digested Sludge," Public Health, vol. 14, no. 1, pp. 27-28.
- Hollister, A.C., M.D. Beck, A.M. Gittelsohn, and E.C. Hemphill, 1955. "Influence of Water Availability on Shigella Prevalence in Children of Farm Labor Families," American Journal of Public Health, vol. 45, pp. 354-62.

- Holmquist, F. 1970. "Implementing Rural Development Projects." In Development Administration--The Kenyan Experience, ed. Hyden, Jackson, and Okumu. Nairobi: Oxford University Press, pp. 201-29.
- Houston, A.C. 1913. Studies in Water Supply. London: MacMillan and Co.
- Hou Tsung-Ch'ang, Chung Hwei-Lan, Ho Lien-Yin and Weng Hsin-Chih. 1959. "Achievements in the Fight Against Parasitic Diseases in New China," Chinese Medical Journal, vol. 79, pp. 493-520.
- Howe, R.H.L. 1976. "Removal of Fecal Coliform from Wastewater by Proper Aerobic Biological Treatment," Process Biochemistry (Jan-Feb), pp. 18-19, 24.
- Huponu-Wusu, O.O. and S.O. Daniel, 1977. "Public Health Aspects of Housing in Nigeria: Observations on the Human Factors in Refuse Disposal in Lagos," Health and Hygiene, vol. 1, no. 3, pp. 153-58.
- Hypes, W.D. 1974. "Characteristics of Typical Household Gray Water." In Manual of Graywater Treatment Practice, ed. J.H.T. Winneberger, Michigan: Ann Arbor Science Publishers, pp. 79-88.
- Imhoff, K. and G.M. Fair, 1956. Sewage Treatment. 2nd ed. New York: John Wiley and Sons.
- Ito, J. 1954. "The Viability of Eggs of S. japonicum in the Excrements of Several Hosts," Nisshin Igaku (Japanese Journal of Medical Progress), vol. 41, no. 7, pp. 370-75.
- Jeffery, G.M. 1960. "A Three-year Epidemiologic Study of Intestinal Parasites in a Selected Group of Mental Patients," American Journal of Hygiene, vol. 71, no. 1, pp. 1-8.
- Jensen, K.E. 1954. "Presence and Destruction of Tubercle Bacilli in sewage." Bulletin of the World Health Organization, vol. 10, pp. 171-79.
- Jepsen, A. and H. Roth, 1949. "Epizootiology of Cysticercus bovis--Resistance of the Eggs of Taenia saginata." In Report of the Fourteenth International Veterinary Congress, vol. 2, London: His Majesty's Stationery Office, pp. 43-50.

Jones, M.F., W.L. Newton, S.R. Weibel, H.B. Warren, M.L. Steinie, and W.B. Figgat, 1947. "The Effects of Sewage Treatment Processes on the Ova and Miracidia of Schistosoma japonicum, National Institute of Health Bulletin, no. 189, pp. 137-72.

Jones, P.W. 1976. "The Effect of Temperature, Solids Content and pH on the Survival of Salmonellae in Cattle Slurry," British Veterinary Journal, vol. 132, pp. 284-93.

Jordan, E.O. 1926. "The Changes in the Bacterial Content of Stored Normal and Typhoid Feces," Journal of Infectious Diseases, vol. 38, pp. 306-22.

_____, H.L. Russell and F.R. Zeit, 1904. "The Longevity of the Typhoid Bacillus in Water," Journal of Infectious Diseases, vol. 1, pp. 641-89.

Josland, S.W. 1951. "Survival of Salmonella typhimurium on Various Substances under Natural Conditions. Australian Veterinary Journal, vol. 27, pp. 264-66.

Kabler, P. 1959. "Removal of Pathogenic Microorganisms by Sewage Treatment Processes," Sewage and Industrial Wastes, vol. 31, pp. 1373-82.

Kaibuchi, Y. 1959. Researches on the Composting of Refuse and Garbage in Kobe City. Kobe: Kobe City (Japan) Sewage Department. Mimeograph.

Kalbermatten, J.M., D.S. Julius, and C.G. Gunnerson. Forthcoming. Appropriate Sanitation Alternatives: A Technical and Economic Appraisal. World Bank Studies in Water Supply and Sanitation, no. 1. Baltimore: Johns Hopkins University Press.

_____, and D. Duncan Mara. Forthcoming. Appropriate Sanitation Alternatives: A Planning and Design Manual. World Bank Studies in Water Supply and Sanitation, no. 2. Baltimore: Johns Hopkins University Press.

Kampelmacher, E.H. and I.M. Van Noorle Jansen, 1972. "Reduction of Bacteria in Sludge Treatment," Journal of the Water Pollution Control Federation, vol. 44, no. 2, pp. 309-13.

Karaseva, E.V., Y.G. Chernukha and L.A. Piskunova, 1973. "Results of Studying the Time of Survival of Pathogenic Leptospira under Natural Conditions," Journal of Hygiene, Epidemiology, Microbiology and Immunology, vol. 17, pp. 339-45.

- Karlinski, J. 1891. "Examination of the Behavior of Typhus Bacillae in Soil." Archiv für Hygiene, vol. 13, pp. 302-33.
- Katayama, Y. 1955. "Sanitary Treatment of Human Excreta by Heating Process, 16: Effect of the Treatment Applied to a Farm Village (Part I)," Japanese Journal of the Nation's Health, vol. 24, pp. 1-12. [English Summary.]
- Katznelson, E., I. Buium, and H.I. Shuval, 1976. "Risk of Communicable Disease Infection Associated with Wastewater Irrigation in Agricultural Settlements," Science, vol. 194, no. 4268, pp. 944-46.
- Kawagoe, K., H. Nishi, E. Shibata and S. Yamada, 1958. "On the Effect of Nightsoil Treatment upon Heating Process Utilizing Surplus Midnight Electric Power upon the Incidence of Parasitic Infection of Farmers," Japanese Journal of the Nation's Health, vol. 27, no. 3, pp. 162-65.
- Kawata, K., W.N. Cramer, and W.D. Burge, 1977. "Composting Destroys Pathogens in Sewage Solids," Water and Sewage Works, vol. 124, no. 4, pp. 76-79.
- _____ and C.W. Krusé, 1966. "The Effect of Sewage Stabilization Ponds on the Eggs and Miracidia of Schistosoma mansoni," American Journal of Tropical Medicine and Hygiene, vol. 15, no. 6, pp. 896-901.
- Keller, P. and C.G. Hide, 1951. "Sterilization of Sewage Sludges: Incidence and Relative Viability of Ascaris Ova at Sewage Disposal Works in the Johannesburg Area," South African Medical Journal, vol. 25, no. 20, pp. 338-42.
- Kelly, S.M., M.E. Clark, and M.B. Coleman, 1955. "Demonstration of Infectious Agents in Sewage," American Journal of Public Health, vol. 45, pp. 1438-46.
- Kelly, S.M. and W.W. Sanderson, 1959. "The Effect of Sewage Treatment on Viruses," Sewage and Industrial Wastes, vol. 31, no. 6, pp. 683-89.
- _____ and C. Neidl, 1961. "Removal of Enteroviruses from Sewage by Activated Sludge," Journal of the Water Pollution Control Federation, vol. 33, no. 10, pp. 1056-62.

- Kelly, S.M., J. Winsser, and W. Winkelstein, 1957. "Poliomyelitis and Other Enteric Viruses in Sewage," American Journal of Public Health, vol. 47, pp. 72-77.
- Khalil, M. 1931. "The Pail Closet as an Efficient Means of Controlling Human Helminth Infection as Observed in Tura Prison, Egypt, with a Discussion on the Source of Ascaris Infection," Annals of Tropical Medicine and Parasitology, vol. 25, no. 1, pp. 35-62.
- Khan, S. and M.N. Agarwal, 1929. "On the Duration of the Life of Vibrios in the Ganges and Jumna River Water," Indian Journal of Medical Research, vol. 16, pp. 993-1008.
- Kirpichnikov, A.A. 1963. "Methods of Treating Town Refuse," Meditsinskaya Parasitologia i Parazitarnye Bolezni, vol. 32, no. 2, pp. 147-51.
- Kleevens, J.W.L. 1966. "Re-housing and Infections by Soil Transmitted Helminths in Singapore," Singapore Medical Journal, vol. 7, pp. 12-29.
- Klein, L. 1966. River Pollution, vol. III, Control. London: Butterworths.
- Kligler, I.J. 1921. "Investigation on Soil Pollution and the Relation of the Various Types of Privies to the Spread of Intestinal Infections," Monographs of the Rockefeller Institute for Medical Research, no. 15.
- Knaack, J. and H. Ritschel, 1975. "How to Eliminate Exogenous Helminth Stages from Municipal Sewage by Means of Different Sewage Purification Techniques," Zeitschrift für die Gesamte Hygiene und Ihre Grenzgebiete, vol. 21, no. 10, pp. 746-50. [English Summary.]
- Knoll, K.H. 1959. "Compost Preparation from the Hygiene Viewpoint." In International Congress on Disposal and Utilization of Town Refuse, Schevenigen, April 27 - May 1, 1959.
- Kochar, V. 1978. "Culture and Hygiene in Rural West Bengal." In Sanitation in Developing Countries, ed. A. Pacey, Chichester: John Wiley and Sons, pp. 176-84.
- Kodama, T., F. Harada, N. Mito, S. Morikubo, and H. Okamoto, 1955. "The Studies about Parasite Control in Rural Areas in Japan: The New Type of Pit Privy to Separate Urine and Stool," Yokohama Medical Bulletin, vol. 6, no. 2, pp. 72-76.

- Kollins, S.A. 1966. "The Presence of Human Enteric Viruses in Sewage and Their Removal by Conventional Sewage Treatment Methods," Advances in Applied Microbiology, vol. 8, pp. 145-93.
- Koltypin, Y.A. 1969. "Decontamination of Sewage in Paddy Fields," Hygiene and Sanitation, vol. 34, no. 7, pp. 87-92.
- Komiya, Y. 1964. "Fasciolopsis buski " In Progress of Medical Parasitology in Japan, ed. K. Morishita, Y. Komiya, and H. Matsubayashi, vol. 1, Tokyo: Meguro Parasitological Museum, pp. 277-85.
- Kott, H. and L. Fishelson, 1974. "Survival of Enteroviruses on Vegetables Irrigated with Chlorinated Oxidation Pond Effluents," Israel Journal of Technology, vol. 12, nos. 5-6, pp. 290-97.
- Kott, H. and Y. Kott, 1967. "Detection and Viability of Entamoeba histolytica Cysts in Sewage Effluents," Water and Sewage Works, vol. 140, pp. 177-80.
- Kott, Y. and N. Betzer, 1972. "The Fate of Vibrio cholerae (El Tor) in Oxidation Pond Effluents," Israel Journal of Medical Science, vol. 8, no. 12, pp. 1912-16.
- Kourany, M. and M.A. Vasquez, 1969. "Housing and Certain Socio-environmental Factors and Prevalence of Enteropathogenic Bacteria among Infants with Diarrheal Disease in Panama," American Journal of Tropical Medicine and Hygiene, vol. 18, no. 6, pp. 936-41.
- Krige, P.R. 1964. "A Survey of the Pathogenic Organisms and Helminthic Ova in Composts and Sewage Sludge," Journal and Proceedings of the Institute of Sewage Purification, no. 3, pp. 215-20.
- Krogstad, O. and R. Gudding, 1975. "The Survival of Some Pathogenic Microorganisms during Reactor Composting," Acta Agriculturae Scandinavica, vol. 25, pp. 281-84.
- Kuenen, W.A. and N.H. Swellengrebel, 1913. "Entamoeba in Man and Its Practical Significance," Zentralblatt für Bakteriologie, Parasitenkunde, Infektionskrankheiten, und Hygiene; Erste Abteilung: Originale, vol. 71, pp. 378-410.

- Kulp, W.L. 1932. "A Note Concerning the Effect of a Specific Environment on the Characteristics and Viability of Several Strains of A. aerogenes and E. coli," Journal of Bacteriology, vol. 24, pp. 317-20.
- Kumar, P., B.S. Sehgal, and R. Singh, 1970. "Bore-hole Disposal of Excreta of Children and Diarrheal Morbidity in a Rural Community," Environmental Health, vol. 12, pp. 155-59.
- Kutsumi, H. 1969. "Epidemiological Study on the Preventive Effect of Thiabendazole as an Ovicide against Human Hookworm, Trichuris, and Ascaris Infections," Japanese Journal of Medical Science and Biology, vol. 22, pp. 51-64. Japanese Journal of Parasitology, vol. 16, no. 1, pp. 15-27.
- Laak, R. 1974. "Relative Pollution Strength of Undiluted Waste Materials Discharged in Households and the Dilution Waters Used for Each." In Manual of Graywater Treatment Practice, ed. J.H.T. Winneberger, Michigan: Ann Arbor Science Publishers, pp. 68-78.
- Lahiri, M.N., P.C. Das, and K.S. Malik, 1939. "The Viability of Vibrio cholerae in Natural Waters," Indian Medical Gazette, vol. 74, pp. 742-44.
- Lakshminarayana, J.S.S. and M.D. Abdulappa, 1972. "The Effect of Sewage Stabilization Ponds on Helminths." In Symposium on Low Cost Waste Treatment, October 1969. Vols. 27-29. Nagpur, India: Central Public Health Engineering Research Institute, pp. 290-99.
- Lamb, G.B. 1974. Peasant Politics. London: Julian Friedmann.
- Larkin, E.P., J.T. Tierney, and R. Sullivan, 1976. "Persistence of Virus on Sewage-irrigated Vegetables," Journal of the Environmental Engineering Division, American Society of Civil Engineers, vol. 102, pp. 29-35.
- Latham, L., M. Latham, and S.S. Basta, 1977. The Nutritional and Economic Implications of Ascaris Infection in Kenya. World Bank Staff Working Paper, no. 271. Washington, D.C.: The World Bank.
- Lefler, E. and Y. Kott, 1974. "Virus Retention and Survival in Sand." In Virus Survival in Water and Wastewater Systems, ed. J.F. Malina and B.P. Sagik. Austin: Center for Research in Water Resources, pp. 84-94.

- Levy, E. and H. Kayser, 1903. "On the Life-span of Typhus Bacillae Which Have Been Passed in Stools," Zentralblatt für Bakteriologie, Parasitenkunde, Infektionskrankheiten, und Hygiene; Erste Abteilung: Originale, vol. 33, pp. 489-95.
- Liebmann, H. 1964. "Parasites in Sewage and the Possibilities of Their Extinction." In Advances in Water Pollution Research, vol. 2, ed. J.K. Baars, Oxford: Pergamon Press, pp. 269-76.
- Little, J.A., B.J. Carroll, and R.E. Gentry, 1970. "Bacteria Removal in Oxidation Ponds." In Second International Symposium for Waste Treatment Lagoons. Sponsored by the Missouri Basin Engineering Health Council and Federal Water Quality Administration, pp. 141-51.
- Little, M.D. and Y. Gutierrez, 1968. "Soil Relations in the Epidemiology of Strongyloidiasis." In Eighth International Congress on Tropical Medicine and Malaria, Teheran, September 7-15, 1968; Abstracts and Reviews, pp. 221-22.
- Löbker and Bruns, H. 1906. "On the Nature and Spread of Helminthic Disease (Anchylostomiasis), with Special Reference to its Occurrence in German Mines," Arbeiten aus dem Kais; Gesundheitsamte, vol. 23, pp. 421-524.
- Lucker, J.T. and F.W. Douvres, 1960. "Survival of Taenia saginata Eggs on Stored Hay," Proceedings of the Helminthological Society of Washington, vol. 27, no. 1, pp. 110-11.
- Lund, E. 1971. "Observations on the Virus Binding Capacity of Sludge." In Proceedings of the Fifth International Conference on Water Pollution, Research, London, 1970, Vol.1, Paper no. I-24, New York: Pergamon Press.
- McCabe, L.J. and T.W. Haines, 1957. "Diarrheal Disease Control by Improving Human Excreta Disposal," Public Health Reports, vol. 72, no. 10, pp. 921-28.
- McCieskey, C.S. and W.N. Christopher, 1941. "The Longevity of Certain Pathogenic Bacteria in Strawberries," Journal of Bacteriology, vol. 41, pp. 98-99.
- McCoy, J.H. 1957. "The Presence and Importance of Salmonella in Sewage," Proceedings of the Society for Water Treatment and Examination, vol. 6, pp. 81-89.

- McFeters, G.A., G.K. Bissonnette, J.J. Jezeski, C.A. Thomson, and D.G. Stuart, 1974. "Comparative Survival of Indicator Bacteria and Enteric Pathogens in Well Water," Applied Microbiology, vol. 27, no. 5, pp. 823-29.
- McGarry, M.G. 1971. "Water Reclamation and Protein Production Through Sewage Treatment." In Water Supply and Wastewater Disposal in Developing Countries: Proceedings of a Water Supply and Sanitation Seminar, Bangkok, January 19-23, 1970. ed. M.B. Pescod and D.A. Okun, Bangkok: Asian Institute of Technology.
- _____. 1977. "Domestic Wastes as an Economic Resource: Biogas and Fish Culture," In Water, Wastes, and Health in Hot Climates, ed. R.G.A. Feachem, M.G. McGarry, and D.D. Mara, London: John Wiley and Sons, pp. 347-64.
- _____. and J. Stainforth, 1978. Compost, Fertilizer, and Biogas Production from Human and Farm Wastes in the People's Republic of China. Ottawa: International Development Research Centre.
- McKinney, R.E., H.E. Langley, and H.D. Tomlinson, 1958. "Survival of Salmonella typhosa During Anaerobic Digestion, 1: Experimental Methods and High-rate Digester Studies," Sewage and Industrial Wastes, vol. 30, no. 12, pp. 1469-77.
- Mack, W.N., J.R. Frey, B.J. Riegler, and W.L. Mallmann, 1962. "Enterovirus Removal by Activated Sludge Treatment," Journal of the Water Pollution Control Federation, vol. 34, no. 11, pp. 1133-39.
- Mackie, T.T., J.W. Mackie, C.M. Vaughn, N.N. Gleason, B.G. Greenberg, E.S. Nenninger, M.N. Lunde, L.L.A. Moore, J.A. Kluttz, and M.O. Taliafero, 1956. "Intestinal Parasitic Infections in Forsyth County, North Carolina, IV: Domestic Environmental Sanitation and the Prevalence of Entamoeba histolytica," American Journal of Tropical Medicine and Hygiene, vol. 5, no. 1, pp. 29-39.
- Maddock, E.C.G. 1933. "Studies on the Survival Time of the Bovine Tubercle Bacillus in Soil, Soil and Dung, in Dung and on Grass, with Experiments on the Preliminary Treatment of Infected Organic Matter and the Cultivation of the Organism," Journal of Hygiene, vol. 3, pp. 103-17.
- Malherbe, H.H. and O.J. Coetzee, 1965. "The Survival of Type '2' Poliovirus in a Model System of Stabilization Ponds." In CSIR Research Report 242. Pretoria: Council for Scientific and Industrial Research.

- Maiherbe, H.H. and M. Strickland-Cholmley, 1967. "Quantitative Studies on Viral Survival in Sewage Purification Processes." In Transmission of Viruses by the Water Route, ed. G. Berg, New York: Wiley/Interscience, pp. 379-88.
- Malina, J.F. Jr., K.R. Ranganathan, B.P. Sagik, and B.E. Moore, 1975. "Poliovirus Inactivation by Activated Sludge," Journal of the Water Pollution Control Federation, vol. 47, no. 8, pp. 2178-83.
- Mallmann, W.L. and W. Litsky, 1951. "Survival of Selected Enteric Organisms in Various Types of Soil," American Journal of Public Health, vol. 41, pp. 38-44.
- Maplestone, P.A. 1928. "The Rate of Loss of Hookworm Eggs from Feces," Indian Medical Gazette, vol. 63, pp. 324-26.
- Mara, D.D. 1974. Bacteriology for Sanitary Engineers. Edinburgh: Churchill Livingstone.
- _____. 1976. Sewage Treatment in Hot Climates. London: John Wiley and Sons.
- Marais, G.v.R. 1966. "New Factors in the Design, Operation and Performance of Waste Stabilization Ponds," Bulletin of the World Health Organization, vol. 34, pp. 737-63.
- Martin, S. 1897-1900. Annual Reports of the Medical Officer of the Local Government Board.
- Mathur, T.N. and J. Kaur, 1972. "The Epidemiology of Amebiasis in an Urban Area," Indian Journal of Medical Research, vol. 60, no. 8, pp. 1134-37.
- Melick, C.O. 1917. "The Possibility of Typhoid Infection through Vegetables," Journal of Infectious Diseases, vol. 21, pp. 28-38.
- Melnick, J.L., C.P. Gerba, and C. Wallis, 1978. "Viruses in Water," Bulletin of the World Health Organization, vol. 56, no. 4, pp. 499-508.
- Merz, R.C., J.C. Merrell, and R. Stone, 1957. "Sewage Works: Investigation of Primary Lagoon Treatment at Mojave, California," Sewage and Industrial Works, vol. 29, no. 2, pp. 115-23.

- Metcalf, L. and H.P. Eddy, 1935. American Sewerage Practice: Disposal of Sewage. Vol. III, 3rd ed. New York: McGraw-Hill.
- Metcalf and Eddy Inc. 1972. Wastewater Engineering: Collection, Treatment, and Disposal. New York: McGraw Hill.
- Mohadjer, S. and S. Mehrabian, 1975. "Studies on the Survival of Shigella flexneri in River and Tap Water," Archives Roumaines de Pathologie Experimentale et de Microbiologie, vol. 34, no. 4, pp. 307-12.
- Mom, C.P. and C.O. Schaeffer, 1940. "Typhoid Bacteria in Sewage and Sludge: An Investigation into the Hygienic Significance of Sewage Purification in the Tropics with Regard to Typhoid Fever," Sewage Works Journal, vol. 12, no. 4, pp. 715-37.
- Moore, H.A., E. De La Cruz, and O. Vargas-Mendez, 1965. "Diarrheal Disease Studies in Costa Rica, IV: The Influence of Sanitation upon the Prevalence of Intestinal Infection and Diarrheal Disease," American Journal of Epidemiology, vol. 82, no. 2, pp. 162-84.
- Muhondwa, E.P.Y. 1976. "Latrine Installation and Use in Bagamoyo District: A Study of Sociological Factors." M.A. thesis, Dar es Salaam: University of Dar es Salaam.
- Murillo, F. 1919. "Cholera, Typhoid and Vegetables," Plus Ultra, vol. 2, p. 115.
- Murray, H.M. 1960. "The Incidence of Ascaris Ova in Pretoria Sludge and Their Reduction by Storage (Maturation) in Large Heaps," Journal and Proceedings of the Institute for Sewage Purification, no. 3, pp. 337-42.
- Myklebust, R.J. and F.C. Harmston, 1962. "Mosquito Production in Stabilization Ponds," Journal of the Water Pollution Control Federation, vol. 34, no. 3, pp. 302-06.
- Nakamura, M., Stone, R.L., and J.E. Krubsack, 1964. "Survival of Shigella in Sea Water," Nature, vol. 203, no. 4941, pp. 213-14.
- Naparstek, J.D., V.P. Olivieri, K. Kawata, and V.R. Sherman, 1976. "Virus Removal in an Activated Sludge Plant," Water and Sewage Works, pp. R-16, R-20.

- National Academy of Sciences. 1976. Making Aquatic Weeds Useful: Some Perspectives for Developing Countries. Washington, D.C.
- Neefe, J.R. and J. Stokes, 1945. "An Epidemic of Infectious Hepatitis Apparently Due to a Water-borne Agent," Journal of the American Medical Association, vol. 128, no. 15, pp. 1063-80.
- Neogy, K.N. 1965. "Viability of V. cholerae and V. El Tor in Food and Water," Bulletin of the Calcutta School of Tropical Medicine, vol. 13, pp. 10-11.
- Newton, W.L., H.J. Bennett, and W.B. Figgat, 1949. "Observations on the Effects of Various Sewage Treatment Processes upon Eggs of Taenia Saginata," American Journal of Hygiene, vol. 49, no. 2, pp. 166-75.
- _____, W.B. Figgat, and S.R. Weibel, 1948. "The Effects of Sewage Treatment Processes upon Ova and Miracidia of Schistosoma japonicum, Part II," Sewage Works Journal, vol. 20, no. 4, pp. 657-64.
- Nicholls, L. and S.A. Gunawardana, 1939. "The Destruction of Helminth Ova in Nightsoil by Composting," Ceylon Journal of Science, vol. 5, no. 1.
- Nicoll, W. 1917. "Observations on the Influence of Salt and Other Agents in Modifying the Larval Development of the Hookworms Ancylostoma duodenale and Necator americanus," Parasitology, vol. 9, pp. 157-89.
- Nishi, S. 1969. "Studies on the Ovicidal Effect of Nightsoil on Ascaris Eggs," Japanese Journal of Parasitology, vol. 18, no. 2, pp. 131-40. [English Summary.]
- Noguchi, H. 1918. "The Survival of Leptospira (Spirochaeta) icterohaemorrhagiae in Nature; Observations Concerning Microchemical Reactions and Intermediary Hosts," Journal of Experimental Medicine, vol. 27, pp. 609-25.
- Nupen, E.M. 1975. "The Effectiveness of Various Techniques for the Removal of Bacteria and Viruses." In Regional Conference on Practical Aspects of Water Supply and Pollution Control in Southern Africa, June 2-5, 1975.

- _____, B.W. Bateman, and N.C. McKenny, 1974. "The Reduction of Virus by the Various Unit Processes Used in the Reclamation of Sewage to Potable Waters." In Virus Survival in Water and Wastewater Systems, ed. J.F. Malina and B.P. Sagik, Austin: Center for Research in Water Resources, pp. 107-14.
- Ohwada, S. 1924. "Destination of Cholera Vibrios in the Sewage Water of Tokyo City," Journal of the Kei-O Medical Society, vol. 3, nos. 11-12.
- Okun, D.A. and G. Ponghis, 1975. Community Wastewater Collection and Disposal. Geneva: World Health Organization.
- Oldt, F. 1926. "Studies on the Viability of Hookworm Eggs in Stored Nightsoil in South China," American Journal of Hygiene, Monograph Series, no. 7, pp. 265-91.
- Oragui, J.I. 1978. On Bacterial Indicators of Water and Sewage Pollution. M.Sc. thesis, Dundee: University of Dundee.
- Oswald, W.J. 1976. "Experiences with New Pond Designs in California," In Ponds as a Wastewater Treatment Alternative, ed. E.F. Gloyna, J.F. Malina, Jr., and E.M. Davis, Austin: Center for Research in Water Resources, pp. 257-72.
- Oswald, W.J., E.W. Lee, B. Adan, and K.H. Yao, 1978. "New Wastewater Treatment Method Yields a Harvest of Saleable Algae," World Health Organization Chronicle, vol. 32, pp. 348-50.
- Otto, G.F., W.W. Cort, and A.E. Keller, 1931. "Environmental Studies of Families in Tennessee Infested with Ascaris, Trichuris and Hookworm," American Journal of Hygiene, vol. 14, pp. 156-93.
- Otto, G.F. and L.A. Spindler, 1930. "Effect of Partial Sanitation on Infestation with Intestinal Parasites in Southwest Virginia," Southern Medical Journal, vol. 23, no. 6, pp. 556-60.
- Pálfi, Á.B. 1972. "Survival of Enteroviruses during Anaerobic Sludge Digestion." In Advances in Water Pollution Research, Oxford: Pergamon Press, pp. 99-107.
- _____, M. Simon, and E. Schulek, 1970. "Virological Examination of Urban Sewage from Budapest, II: Experiments for Isolating Viruses from Wastewater," Egészségtudomány, vol. 14, pp. 127-32.

- Pandit, C.G., S.C. Pal, G.V.S. Murti, B.S. Misra, D.K. Murty, and J.B. Shrivastav, 1967. "Survival of Vibrio cholerae Biotype El Tor in Well Water," Bulletin of the World Health Organization, vol. 37, pp. 681-85.
- Parker, C.D. 1962. "Microbiological Aspects of Lagoon Treatment," Journal of the Water Pollution Control Federation, vol. 34, no. 2, pp. 149-61.
- Pesch, K.L. and E. Sauerborn, 1929. "Chemical and Bacteriological Sewage Investigations," Gesundheits Ingenieur, vol. 52, p. 856.
- Pescod, M.B. 1971. "Wastewater Solids Utilization and Disposal in Tropical Developing Countries." In Water Supply and Wastewater Disposal in Developing Countries: Proceedings of a Water Supply and Sanitation Seminar, Bangkok, January 19-23, 1970, ed. M.B. Pescod and D.A. Okun, Bangkok: Asian Institute of Technology, pp. 208-26.
- Pesigan, T.P., J. Plantilla, and M. Rolda, 1967. "Applied Studies on the Viability of El Tor Vibrios," Bulletin of the World Health Organization, vol. 37, pp. 779-86.
- Petrik, M. 1954. "Utilization of Nightsoil, Sewage, and Sewage Sludge in Agriculture," Bulletin of the World Health Organization, vol. 10, pp. 207-28.
- Platt, A.E. 1953. "The Viability of Bact. coli and Bact. aerogenes in Water: A Method for the Rapid Enumeration of These Organisms," Journal of Hygiene, vol. 35, pp. 437-47.
- Pradt, L.A. 1971. "Some Recent Developments in Nightsoil Treatment," Water Research, vol. 5, pp. 507-21.
- Pramer, D., H. Heukelekian, and R.A. Ragotzkie, 1950. "Survival of Tubercle Bacilli in Various Sewage Treatment Processes, I: Development of a Method for the Quantitative Recovery of Mycobacteria from Sewage," Public Health Reports, vol. 65, no. 27, pp. 851-59.
- Purushothaman, K. 1970. "Field Studies on Stabilization Ponds in South India." In Second International Symposium for Waste Treatment Lagoons, Sponsored by the Missouri Basin Health Council and Federal Water Quality Administration, pp. 80-88.

- Raghavachari, T.N.S. and P.V.S. Iyer, 1939. "The Coii-Aerogenes Index of Pollution Used in the Bacteriological Analysis of Water," Indian Journal of Medical Research, vol. 26, no. 4, pp. 867-75.
- Rajagopalan, S. and M.A. Shiffman, 1974. Guide to Simple Sanitary Measures for the Control of Enteric Diseases. Geneva: World Health Organization.
- Rao, V.C., P. Kumaran, S.B. Lakhe, P. Dube, and N.U. Rao, 1973. "Virus Removal in Sewage Treatment Pilot Plants, Part 1: Oxidation Ditch." In Proceedings of a Symposium on Environmental Pollution. Nagpur, India: Central Public Health Engineering Research Institute, pp. 174-80.
- Read, W.D.B., J. Gurkirpai Singh, S.C. Seals, and S. Bose, 1939. "Growth and Survival of V. cholerae with Special Reference to Growth and Survival in Water," Indian Journal of Medical Research, vol. 27, pp. 1-40.
- Reeves, J.B. 1959. "Sanitary Aspects of Composted Sewage, Sludge and Sawdust," Sewage and Industrial Wastes, vol. 31, no. 5, pp. 557-64.
- Rendtorff, R.C. and Holt, C.J. 1954. "The Experimental Transmission of Human Intestinal Protozoan Parasites, IV: Attempts to Transmit Entamoeba coli and Giardia lamblia Cysts by Water," American Journal of Hygiene, vol. 60, pp. 327-38.
- Rew, A. 1977. "Urban Water: Access, Delivery and Institutional Scarcity." Institute of Development Studies Occasional Paper. Brighton: University of Sussex.
- Reyes, W.L., C.W. Kruse and M.S. Batson, 1963. "The Effect of Aerobic and Anaerobic Digestion on Eggs of Ascaris lumbricoides var. suum in Nightsoil," American Journal of Tropical Medicine and Hygiene, vol. 12, no. 1, pp. 46-55.
- Rhodes, A.J., E.M. Clark, D.S. Knowles, A.M. Goodfellow, and W.L. Donohue, 1950. "Prolonged Survival of Human Poliomyelitis Virus in Experimentally Infected River Water," Canadian Journal of Public Health, vol. 41, pp. 146-49.

- Rhodes, A.J., E.M. Clark, D.S. Knowles, F. Shimada, A.M. Goodfellow, R.C. Ritchie, and W.L. Donohue, 1950. "Poliomyelitis Virus in Urban Sewage: An Examination for its Presence over a Period of Twelve Months," Canadian Journal of Public Health, vol. 41, pp. 248-54.
- Robertson, J. 1898. "Notes on an Experimental Investigation into the Growth of *Bacillus Typhosus* in Soil," British Medical Journal, vol. 1, pp. 69-71.
- Rosenberg, A.I. 1960. "Sanitary and Hygienic Measures for the Control of Focal Ascariasis," Meditsinskaya Parasitologia i Parazitarnye Bolezni, vol. 29, no. 2, pp. 143-49. [English Summary.]
- Rowan, W.B. 1964. "Sewage Treatment and Schistosome Eggs," American Journal of Tropical Medicine and Hygiene, vol. 13, no. 4, pp. 572-76.
- Ruchhoft, C.C. 1934. "Studies on the Longevity of *Bacillus typhosus* (*Eberthella typhi*) in Sewage Sludge," Sewage Works Journal, vol. 6, no. 6, pp. 1054-57.
- Rudolfs, W., L.L. Falk, and R.A. Ragotzkie, 1950. "Literature Review on the Occurrence and Survival of Enteric, Pathogenic and Relative Organisms in Soil, Water, Sewage and Sludges, and on Vegetation, 1: Bacterial and Virus Diseases," Sewage and Industrial Wastes, vol. 22, pp. 1261-81.
- _____ . 1951:I. "Contamination of Vegetables Grown in Polluted Soil, I: Bacterial Contamination," Sewage and Industrial Wastes, vol. 23, no. 3, pp. 253-68.
- _____ . 1951:II. "Contamination of Vegetables Grown in Polluted Soil, II: Field and Laboratory Studies on *Entamoeba* Cysts," Sewage and Industrial Wastes, vol. 23, no. 4, pp. 478-85.
- _____ . 1951.:III. "Contamination of Vegetables Grown in Polluted Soil, III: Field Studies on *Ascaris* Eggs," Sewage and Industrial Wastes, vol. 23, no. 5, pp. 656-60.
- _____ . 1951:IV. "Contamination of Vegetables Grown in Polluted Soil, IV: Bacterial Decontamination," Sewage and Industrial Wastes, vol. 23, no. 6, pp. 739-53.
- _____ . 1951:V. "Contamination of Vegetables Grown in Polluted Soil, V: Helminthic Decontamination," Sewage and Industrial Wastes, vol. 23, no. 7, pp. 853-60.

- _____. 1951:VI. "Contamination of Vegetables Grown in Polluted Soil, VI: Application of Results," Sewage and Industrial Wastes, vol. 23, no. 8, pp. 992-1000.
- Rulümann, W. 1901. "On the Behaviour of Typhus Bacillae Sown in the Soil," Zentralblatt für Bakteriologie, Parasitenkunde, Infektionskrankheiten, und Hygiene; Erste Abteilung: Originale, vol. 30, pp. 321-35.
- Russell, H.L. and C.A. Fuller. 1906. "The Longevity of Bacillus Typhus in Natural Waters and in Sewage," Journal of Infectious Diseases, Supplement 2, pp. 40-79.
- Rybczynski, W., C. Polprasert, and M.G. McGarry. 1978. Low-Cost Technology Options for Sanitation: A State-of-the-Art Review and Annotated Bibliography. IDRC/World Bank: IDRC 102e/Appropriate Technology for Water Supply and Sanitation, vol. 4. Ottawa: International Development Research Centre.
- Sadovski, A.Y., B. Fattal, E. Katzenelson, D. Golberg, and H.I. Shuval. 1976. A Study of the Distribution and Survival of Enteric Viruses and Bacteria during Simulated Epidemics in Soil and Crops Irrigated with Wastewater by the Drip Irrigation Method," Proceedings of the Seventh Scientific Conference of the Israel Ecological Society, Tel Aviv, October 11-12, 1976, pp. 221-35.
- Safferman, R.S. and M.E. Morris. 1976. "Assessment of Virus Removal by a Multistage Activated Sludge Process," Water Research, vol. 10, no. 5, pp. 413-20.
- Sahba, G.H. and F. Arfaa. 1967. "The Effect of Sanitation on Ascariasis in an Iranian Village," Journal of Tropical Medicine and Hygiene, vol. 70, pp. 37-41.
- Savage, J., J.D. Macmillan, and T. CHASE, Jr. 1972. "Composting Conditions and Survival of Intestinal Pathogens in Hog Waste Windrow Compost," Abstracts of the Annual Meeting of the American Society for Microbiology, no. E47, p. 8.
- Schaffer, B.B. 1969. "The Deadlock in Development Administration." In Politics and Change in Developing Countries, ed. C. Leys, Cambridge: Cambridge University Press, pp. 177-211.
- Schenk-Sandbergen, L.D. 1975. "Sweepers and Nightsoil Collectors in China-- No Longer a Subprotectorate." Unpublished paper cited in Streefland (1978).

- Schliessmann, D.J., F.O. Atchley, M.J. Wilcomb, Jr., and S.F. Welch. 1958. "Relationship of Environmental Factors to the Occurrence of Enteric Diseases in Areas of Eastern Kentucky," Public Health Monograph no. 54. Washington: U.S. Government Printing Office.
- Scott, J.A. and C.H. Barlow. 1938. "Limitations to the Control of Helminth Parasites in Egypt by Means of Treatment and Sanitation," American Journal of Hygiene, vol. 27, pp. 619-48.
- Scott, J.C. 1952. Health and Agriculture in China: A Fundamental Approach to Some of the Problems of World Hunger. London: Faber and Faber, Ltd.
- Sedgwick, W.T. and C.E.A. Winslow. 1902. "Experiments on the Effect of Freezing and Other Low Temperatures upon the Viability of the Bacillus of Typhoid Fever with Considerations Regarding Ice as a Vehicle of Infectious Disease." Cited in Rudolfs (1950).
- Shablovskaya, E.A. 1963. "Some Data on the Vertical Migration of Strongyloides stercoralis in the Soil," Trudi Ukrainського Respublikanskogo Nauchnogo Obshchestva Parazitogov, no. 2, pp. 74-80.
- Shephard, M. 1977. "Helminthological Aspects of Sewage Treatment in Hot Climates." In Water, Wastes, and Health in Hot Climates, ed. R.G.A. Feachem, M.G. McGarry, and D.D. Mara, London: John Wiley and Sons, pp. 299-310.
- Shepelev, D.S. 1961. "Survival of Taenia hydatigena Eggs in the External Environment," Sbornik Rabot. Vologodskaya Nauchno-Issledovatel'skaya Veterinarnaya Stantsiya, vol. 5, pp. 143-45.
- Sherman, V.R., K. Kawata, V.P. Olivieri, and J.D. Naparstek. 1975. "Virus Removals in Trickling Filter Plants," Water and Sewage Works, vol. 122(RN), pp. R36-44.
- Shoda, T., T. Koreyeda, and T. Otomo. 1934. "The Viability of Cholera Vibrios in the Human Excreta," Journal of the Public Health Association of Japan, vol. 10, pp. 1-9.
- Shuval, H.I. 1970. Developments in Water Quality Research, Ann Arbor: Humphrey Science Publishers.

- _____. 1977. "Public Health Considerations in Wastewater and Excreta Reuse for Agriculture." In Water, Wastes, and Health in Hot Climates, ed. R.G.A. Feachem, M.G. McGarry, and D.D. Mara, London: John Wiley and Sons, pp. 365-81.
- _____. 1978. "Parasitic Disease and Wastewater Irrigation." In Sanitation in Developing Countries, ed. A. Pacey, Chichester: John Wiley and Sons, pp. 210-15.
- _____, and N. Gruener. 1977. Health Effects of Nitrates in Water. Report No. PB/270479, Springfield, Virginia: U.S. National Technical Information Service.
- _____, C.G. Gunnerson, and D.S. Julius. 1980. Appropriate Technology for Water Supply and Sanitation, vol. 10, Night-soil Composting. Washington, D.C.: The World Bank, Transportation, Water, and Telecommunications Department.
- Silverman, P.H. 1956. "The Longevity of Eggs of Taenia pisiformis and T. saginata under Various Conditions," Transactions of the Royal Society of Tropical Medicine and Hygiene, vol. 50, no. 1, pp. 7-8.
- _____, and R.B. Griffiths. 1955. "A Review of Methods of Sewage Disposal in Great Britain, with Special Reference to the Epizootiology of Cysticercus bovis." Annals of Tropical Medicine and Parasitology, vol. 49, no. 4, pp. 436-50.
- _____, and K. Guiver. 1960. "Survival of Eggs of Taenia saginata (the Human Beef Tapeworm) after Mesophilic Anaerobic Digestion," Journal and Proceedings of the Institute for Sewage Purification, no. 3, pp. 345-47.
- Simitch, T., A. Bordjochki, and T. Angelovski. 1955. "Longevity of Embryos in the Eggs of Hymenolepis nana Outside the Host," Archives de l'Institut Pasteur d'Algérie, vol. 33, no. 1, pp. 30-34.
- Simitch, T., Z. Petrovitch, and D. Chibalitch. 1954. "Viability of Cysts of Entamoeba histolytica Outside the Host," Archives de l'Institut Pasteur d'Algérie, vol. 32, no. 3, pp. 223-31.
- Six, F. and K. Hoffmann. 1970. "The Survival of Fasciola hepatica Eggs in Liquid Manure and Diluted Liquid Manure with or without the Addition of One of the Shell Products, Birlane Fluid or Frescon 16%," Tierärztliche Umschau, vol. 25, pp. 584-86, 589-90.

- Skinner, C.E. and T.J. Murray. 1926. "The Viability of B. coli and B. aerogenes in Soil," Journal of Infectious Diseases, vol. 38, pp. 37-41.
- Slanetz, L.W., C.H. Bartley, T.G. Metcalf, and R. Nesman. 1970. "Survival of Enteric Bacteria and Viruses in Municipal Sewage Lagoons. In Proceedings of the Second International Symposium for Waste Treatment Lagoons, Kansas City, June 23-25, 1970, ed. R.E. McKinney.
- Snell, J.R. 1943. "Anaerobic Digestion, 3: Anaerobic Digestion of undiluted Human Excreta," Sewage Works Journal, vol. 15, no. 4, pp. 679-701.
- Solly, R.K. 1977. "A Study of Methane Digestors in the South Pacific Region," Appropriate Technology, vol. 3, no. 4, pp. 23-25.
- Sorber, C.A. and K.J. Guter. 1975. "Health and Hygiene Aspects of Spray Irrigation," American Journal of Public Health, vol. 65, no. 1, pp. 47-52.
- Spencer, K. 1978. "Managing the Expansion of Port Sudan," Paper presented to the Red Sea Hills Development Conference. Birmingham: Institute of Local Government Studies, Birmingham University.
- Stander, G.J. and A.J. Clayton. 1977. "Planning and Construction of Wastewater Reclamation Schemes as an Integral Part of Water Supply." In Water, Wastes, and Health in Hot Climates, ed. R.G.A. Feachem, M.G. McGarry, and D.D. Mara, London: John Wiley and Sons, pp. 383-91.
- Stewart, W.H., L.J. McCabe, E.C. Hemphill, and T. DeCapito, T. 1955. "Diarrhoeal Disease Control Studies IV: Relationship of Certain Environmental Factors to the Prevalence of Shigella Infection," American Journal of Tropical Medicine and Hygiene, vol. 4, pp. 718-24.
- Stokes, E.J., E.E. Jones, A.F. Mohun, and A.A. Miles. 1945. "Effect of Drying and Digestion of Sewage Sludge on Certain Pathogenic Organisms," Journal and Proceedings of the Institute of Sewage Purification, vol. 1, pp. 36-44.
- Stone, R. 1949. "The Shaoyang, China, Nightsoil Fertilizer Reclamation Plant," Sewage Works Journal, vol. 21, no. 6, pp. 992-1001.

- Streefland, P.H. 1978. "The Social Organization of Nightsoil Collection." In Sanitation in Developing Countries, ed. A. Pacey, Chichester: John Wiley and Sons, pp. 133-38.
- Streeter, H.W. 1930. "The Effect of Activated Sludge on Pathogenic Organisms," Sewage Works Journal, vol. 2, no. 2, pp. 292-95.
- Styczyńska-Jurewicz, E. 1965. "The Influence of a Brackish Environment on the Development of Eggs and Viability of Miracidia of Fasciola hepatica," Acta Parasitologica Polonica, vol. 13, nos. 39/46, pp. 483-97.
- Subrahmanyam, T.P. 1977. "Persistence of Enteroviruses in Sewage Sludge," Bulletin of the World Health Organization, vol. 55, no. 4, pp. 431-34.
- Sundaresan, B.B., S. Muthuswamy, and V.S. Govindan. 1978. "A Wastewater Treatment and Reuse Demonstration." In Proceedings of a Conference on Sanitation in Developing Countries Today, Oxford, July 5-9, 1977. Oxford: Oxfam, pp. 208-10.
- Sweet, W.C., W.W. Cort, L. Schapiro, N.R. Stoll, and W.A. Riley. 1929. "A Study of the Effect of Treatment and Sanitation on the Level of Hookworm Infestation in Certain Areas in Panama," American Journal of Hygiene, Monograph Series, no. 9, pp. 98-138.
- Takano, R., I. Ohtsubo, and Z. Inouye. 1926. Studies of Cholera in Japan. Publication no. CH 515. Geneva: League of Nations.
- Tandon, R.K. and B.N. Tandon. 1975. "Stool Weights in North Indians," Lancet, vol. ii, pp. 560-61.
- Tannock, G.W. and J.M.B. Smith. 1972. "Studies on the Survival of Salmonella typhimurium and Salmonella bovismorbificans in Soil and Sheep Feces," Research of Veterinary Science, vol. 13, no. 2, pp. 150-53.
- Taylor, R.J. and M.R. Burrows. 1971. "The Survival of Escherichia coli and Salmonella dublin in Slurry on Pasture and the Infectivity of S. dublin for Grazing Calves," British Veterinary Journal, vol. 127, no. 11, pp. 536-43.
- Tebbutt, T.H.Y. 1977. Principles of Water Quality Control. Oxford: Pergamon Press.

- Thomas, K.L. 1967. "Survival of S. paratyphi (B. phage type 1 var. 6) in Soil; Monthly Bulletin of the Ministry of Health and the Public Health Laboratory Service, vol. 26, pp. 39-45.
- Tierney, J.T., R. Sullivan, and E.P. Larkin. 1977. "Persistence of Poliovirus 1 in Soil and on Vegetables Grown in Soil Previously Flooded with Inoculated Sewage Sludge or Effluent," Applied and Environmental Microbiology, vol. 33, no. 1, pp. 109-13.
- Usacheva, A.M. 1951. "Survival of Helminth Eggs in Water and in River Sediment," Gigiena i Sanitaria, no. 12, pp. 12-17.
- Van Donsel, D.J., E.E. Geldreich, and N.A. Clarke. 1967. "Seasonal Variations in Survival of Indicator Bacteria in Soil and Their Contribution to Stormwater Pollution," Applied Microbiology, vol. 15, pp. 1362-70.
- Van Zijl, W.J. 1966. "Studies on Diarrheal Diseases in Seven Countries by the World Health Organization Diarrheal Disease Advisory Team," Bulletin of the World Health Organization, vol. 35, no. 2, pp. 249-61.
- Vanderzant, C. and R. Nickelson. 1973. "Vibrio parahaemolyticus: a Problem in Mariculture?" Journal of Milk and Food Technology, vol. 36, no. 3, pp. 135-39.
- Vassilkova, Z. 1936. "On the Dehelminthization of Purified Sewage by Intensive Methods," Meditinskaya Parasitologia i Parazitarnye Bolezni, vol. 5, pp. 657-74.
- Villarejos, V.M., W. Pelon, B. Picado, J.G. Ortiz, R. Jimenez, and H. Navas. 1966. "Epidemiologic Investigation of an Outbreak of Infectious Hepatitis in Costa Rica," American Journal of Epidemiology, vol. 84, no. 3, pp. 457-66.
- Vishnevskaya, S.M. 1938. "The Degree of Dehelminthization of Sewage at the Kharkov Bio-station," Meditinskaya Parasitologia i Parazitarnye Bolezni, vol. 7, no. 3, pp. 450-54. [English Summary.]
- Wagner, E.G. and J.N. Lanoix. 1958. Excreta Disposal for Rural Areas and Small Communities. Geneva: World Health Organization.
1969. Water Supply for Rural Areas and Small Communities. Geneva: World Health Organization.

- Walker, A.R.P. 1975. "Effect of High Crude Fiber Intake on Transit Time and the Absorption of Nutrients in South African Negro School Children," American Journal of Clinical Nutrition, vol. 28, pp. 1161-69.
- Ware, G.C. and M.A. Mellon. 1956. "Some Observations on the Coli/Coliphage Relationship in Sewage," Journal of Hygiene, vol. 54, pp. 99-101.
- Webber; D.G. 1974. Survival of Vibrio cholerae Biotypes in Anaerobic Sewage Sludge Liquor. Oxford: Oxfam.
- Weir, J.M., I.M. Wasif, F.R. Hassan, S.D.M. Attia, and M.A. KADER. 1952. "An Evaluation of Health and Sanitation in Egyptian Villages," Journal of the Egyptian Public Health Association, vol. 27, no. 3, pp. 53-122.
- Wheeler, J.M. 1906. "The Viability of Bacillus typhosus under Various Conditions," Journal of Medical Research, vol. 15, no. 2, pp. 259-99.
- Whipple, G.C. and A. Mayer. 1904. "On the Relation Between Oxygen in Water and the Longevity of Typhoid Bacillus," Journal of Infectious Diseases, vol. 1, pp. 76-79.
- White, A.U. 1977. "Patterns of Domestic Water Use in Low-income Communities." In Water, Wastes, and Health in Hot Climates, ed. R.G.A. Feachem, M.G. McGarry, and D.D. Mara, London: John Wiley and Sons, pp. 96-112.
- White, G.F., D.J. Bradley, and A.U. White. 1972. Drawers of Water: Domestic Water Use in East Africa. Chicago: The University of Chicago Press.
- Wiley, B.B. and S.C. Westerberg. 1969. "Survival of Human Pathogens in Composted Sewage," Applied Microbiology, vol. 18, pp. 994-1001.
- Wiley, J.S. 1962. "Pathogen Survival in Composting Municipal Wastes," Journal of the Water Pollution Control Federation, vol. 34, pp. 80-90.
- Williams, R.S. and W.A. Hoy. 1930. "The Viability of B. tuberculosis (Bovinus) on Pasture Land, in Stored Feces, and in Liquid Manure," Journal of Hygiene, vol. 30, pp. 413-19.
- Wilson, G.S. and A.A. Miles. 1955. Topley and Wilson's Principles of Bacteriology and Immunity. 4th ed. (2 vols.) London: Edward Arnold, Ltd.

- Winfield, G.F. 1937. "Studies on the Control of Fecal-borne Diseases in North China, III: Family Environmental Factors Affecting the Spread of Ascaris lumbricoides in a Rural Population," Chinese Medical Journal, vol. 51, pp. 643-58.
- Winneberger, J.H.T. 1974. Manual of Graywater Treatment Practice. Michigan: Ann Arbor Science Publishers.
- Witt, M., R. Siegrist, and W.C. Boyle. 1974. "Rural Household Wastewater Characteristics." In Proceedings of the National Home Sewage Disposal Symposium, Chicago, December 9-10, 1974. Michigan: American Society of Agricultural Engineers, pp. 79-88.
- Wolverton, W. and R.C. McDonald. 1976. "Don't Waste Waterweeds," New Scientist, vol. 71, no. 1013, pp. 318-20.
- World Health Organization. 1970. Sewerage Planning in the Greater Taipei Area: A Master Plan Report. WHO/UNDP/CHA-27. Geneva.
- World Health Organization. 1973. "Reuse of Effluents: Methods of Wastewater Treatment and Health Safeguards," World Health Organization Technical Report Series, no. 517.
- Wright, W.H., E.B. Cram, and M.O. Nolan. 1942. "Preliminary Observations on the Effect of Sewage Treatment Processes on the Ova and Cysts of Intestinal Parasites," Sewage Works Journal, vol. 14, no. 6, pp. 1274-80.
- Young, C.C. and M. Greenfield. 1923. "Observations on the Viability of the Bacterium coli Group under Natural and Artificial Conditions," American Journal of Public Health, vol. 13, pp. 270-73.
- Zaidenov, A.M. 1976. "Prolonged Survival of El Tor Cholera Vibrio in Naturally Infested Sewage," Zhurnal Mikrobiologii, Epidemiologii, i Immunobiologii, no. 12, pp. 61-65.

* * * * *

World Bank

Headquarters:

1818 H Street, N.W.

Washington, D.C. 20433, U.S.A.

Telephone: (202) 477-1234

Cable address: INTBAFRAD
WASHINGTONDC



European Office:

66, avenue d'Iéna

75116 Paris, France



1981-1990