

# Sanitation & Water Supply in Low-income Countries

Barbara Evans & Duncan Mara



Download free books at

[bookboon.com](http://bookboon.com)

Duncan Mara and Barbara Evans

# Sanitation and Water Supply in Low-income Countries

---

Sanitation and Water Supply in Low-income Countries  
© 2011 Duncan Mara, Barbara Evans & Ventus Publishing ApS  
ISBN 978-87-7681-866-1

# Contents

<b>Preface</b>	<b>8</b>	
<b>1</b>	<b>Introduction to the Global Sanitation and Water-Supply Crisis</b>	<b>9</b>
1.1	The Magnitude of the Crisis	9
1.2	Disease, Stunting and Cognitive Impairment	13
1.3	Personal Safety and Dignity	15
1.4	Solutions to the Crisis	15
	References	16
	Chapter 1: Key Messages	18
<b>2</b>	<b>Water- and Excreta-related Diseases</b>	<b>19</b>
2.1	Introduction	19
2.2	The Global Health Impact of Water and excreta related diseases	20
2.3	Environmental Classification of Water and excreta related diseases	20
	References	32
	Chapter 2: Key Messages	34
<b>3</b>	<b>Sanitation Systems</b>	<b>35</b>
3.1	Rural Areas	35
3.2	Small towns and large villages	42

Please click the advert



Discover the truth at [www.deloitte.ca/careers](http://www.deloitte.ca/careers)

**Deloitte.**

© Deloitte & Touche LLP and affiliated entities.

3.3	High-density urban areas	49
3.4	Sociocultural factors	57
3.5	School sanitation	59
3.6	Ecological sanitation	59
	References	61
	Chapter 3: Key Messages	67
<b>4</b>	<b>Water Supply Systems</b>	<b>68</b>
4.1	Rural Areas	68
4.2	Urban areas	81
	References	87
	Chapter 4: Key Messages	90
<b>5</b>	<b>Programming and Planning</b>	<b>91</b>
5.1	Getting Started - Understanding where the constraints lie	92
5.2	Participatory Planning Tools	93
5.3	Inducing Behaviour Change and Promoting Hygiene	96
5.4	Creating Sanitation Markets	98
5.5	Management options for rural water supplies	101
5.6	Urban Water and Sanitation Planning	104
	References	106
	Further Reading	107

Chapter 5: Key Messages	108
<b>6 Economics and Financing</b>	<b>109</b>
6.1 What does it cost?	109
6.2 The Economics of Sanitation and Water Supply	113
6.3 Financial Assessments	114
6.4 Subsidies	114
References	122
Further Reading	123
Chapter 6: Key Messages	123
<b>Annex A 124</b>	
Design of On-Site Sanitation Systems	124
A.1 Single-pit VIP latrines	124
A.2 eThekwini latrines	125
A.3 Single-pit pour-flush latrines	125
A.4 Alternating twin-pit pour-flush latrines	126
<b>Annex B 127</b>	
Hydraulic Design of Simplified Sewers	127
B.1 Notation	127
B.2 Properties of a circular section	128
B.3 Design procedure	132

References	139
<b>Annex C 140</b>	
Hydraulic Design of Low-Cost Combined Sewers	140
C.1 Basis of Hydraulic Design	140
C.2 Stormwater Flows	140
References	145
Further reading	145
<b>Annex D 146</b>	
Useful Websites	146
<b>Abbreviations and acronyms</b>	<b>148</b>

Please click the advert



**MSM**  
**MAASTRICHT SCHOOL OF MANAGEMENT**

**Increase your impact with MSM Executive Education**



For almost 60 years Maastricht School of Management has been enhancing the management capacity of professionals and organizations around the world through state-of-the-art management education.

Our broad range of Open Enrollment Executive Programs offers you a unique interactive, stimulating and multicultural learning experience.

**Be prepared for tomorrow's management challenges and apply today.**

For more information, visit [www.msm.nl](http://www.msm.nl) or contact us at +31 43 38 70 808 or via [admissions@msm.nl](mailto:admissions@msm.nl)

the globally networked management school

# Preface

Water supply and sanitation are amongst the most basic requirements of life. For the past 50 to 150 years people living in Europe, America and a few capital cities elsewhere around the globe have come to take for granted the provision of a virtually limitless supply of clean, safe water and the seemingly effortless removal of all human wastes 'out of sight and out of mind'. That this miracle of collective political will, urban planning and engineering bravura is so much taken for granted is credit to the public health engineers, planners, civic administrators and politicians who made it possible. That we should take it for granted is wholly unacceptable.

The reason is that for hundreds of millions of people, the struggle for water is an all too real, daily reality, and there are still over 1 billion people defecating daily in the bush, alongside the railway tracks or in the lanes behind their houses. Sanitation and water supply remain distant dreams for millions of people all over the world. Precisely because so much has been achieved, much has been lost. Sanitation and water supply are rarely seen as political 'winners' anymore. Too much effort is expended on the wrong solutions – much has been learned but much has been forgotten. This book is about basic engineering common sense. It is about understanding the real nature of the public health crisis that confronts us.

Recent research confirms the growing problem of antibiotic-resistant strains of bacteria; many of them the same pathogens that transmit disease from infected people to healthy people by means of their faeces, including those responsible for cholera and dysentery. In countries where these diseases are endemic this raises the spectre of a widespread public health disaster with no cure. It is inevitable that the medical research community and many of their donors will call for more money for research; inevitable too that the focus will be on yet more medical interventions that can help fight off this new killer. Yet we already have the solution to hand. More than 150 years ago, John Snow successfully proved that the surest way of preventing deaths from faeco-oral diseases (that is diseases that are passed on from one sick host to the next victim via the victim's faeces) is to stop those faeces from getting in to the water supply in the first place (see Box 2.2). And we already have the technologies to do it too – simple toilets, well-managed septage systems, e-Thekwini latrines, simplified sewerage, simple water supply technology and, best of all, handwashing with soap – all these have been demonstrated to safely protect people from faeco-oral diseases time and time again.

So this book is also all about saving lives, right here and right now. The United Nations only declared sanitation and water as human rights last year, but it seems astonishing that they needed to do so at all. Surely the right to live without daily exposure to human faeces has been recognised long ago in wider recognition of human rights to dignity and health.

The aim of this book is to both inspire and instruct – to show how easy it is to save lives and yet what an immense and important challenge it still remains.

*Duncan Mara and Barbara Evans*

*Leeds, August 2011*



# 1 Introduction to the Global Sanitation and Water-Supply Crisis

## 1.1 The Magnitude of the Crisis

The World Health Organization and UNICEF reported that in 2008, when the world population was just over 6,750 million, there were around 2,600 million people in the world, almost all of whom were in developing countries, who did not have access to an ‘improved’ sanitation facility, and some 884 million people, again almost all in developing countries, without access to an ‘improved’ water supply (see Table 1.1 for the definitions of ‘improved’ sanitation and water supplies).<sup>[1]</sup> Of those without access to improved sanitation, some 1,100 million had no sanitation facilities at all and so had to defecate in the open – these are the so-called ‘open defecators’. Most of the people without access to improved sanitation and water supplies are poor – Figures 1.1 and 1.2 illustrate this for sanitation in India.<sup>[2]</sup>

**Table 1.1:** WHO/UNICEF definitions of ‘improved’ sanitation and ‘improved’ water supplies (details of sanitation and water supply technologies are given in Chapters 3 and 4).

Improved sanitation	Improved water supplies
Connection to a public sewer	Household connection
Connection to a septic system	Public standpipe
Pour-flush latrine	Borehole
Simple pit latrine with cover slab	Protected dug well
Ventilated improved pit latrine	Protected spring
	Rainwater collection

Developing countries and the international community (United Nations agencies, multilateral and bilateral aid agencies and development banks, and charitable organizations) have been working since 1980 to achieve ‘Sanitation and Water and for All’. First there was the International Drinking Water and Sanitation Decade (1981–1990); then Safe Water 2000 (1991–2000), which despite its title included sanitation; and now there are the water and sanitation targets of the Millennium Development Goals (MDGs) which are to reduce by half the proportion of people without access to improved sanitation and water supplies, taking 1990 as the base year, by the end of 2015.<sup>[3]</sup> These MDG targets may well help focus developing-country governments and the international community on the sanitation and water supply crisis, but, even if they are achieved (which now seems unlikely, especially for sanitation), they do not address the whole problem as there will still be many hundreds of millions of people without access to improved sanitation and water supplies in 2015 and beyond. The only really meaningful target is universal coverage – i.e., Sanitation and Water for **All**.

These figures for the number of people without access to improved sanitation and water supplies, while extremely alarming, may actually be gross underestimates as the definitions used for ‘improved’ sanitation and water supplies are based solely on access to sanitation and water-supply technologies. The definitions tell us nothing about how well the systems are working (or if they are working at all), whether they are affordable, or how much time people spend collecting water. As the Asian Development Bank

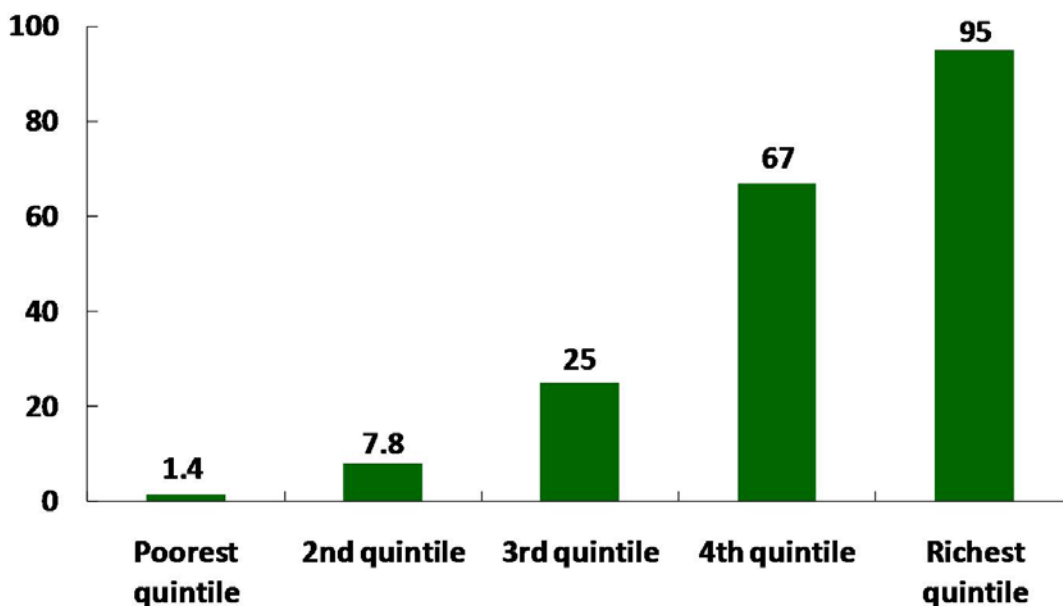


Figure 1.1: Percentage of Indians with flush toilets, by wealth quintile, in 2005/06.

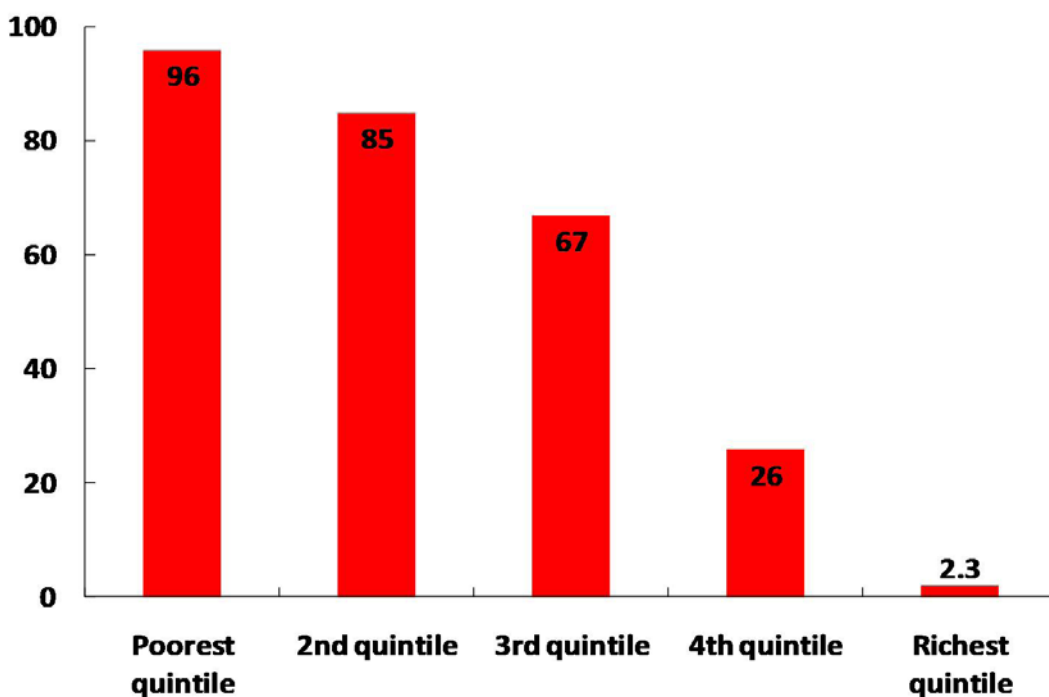


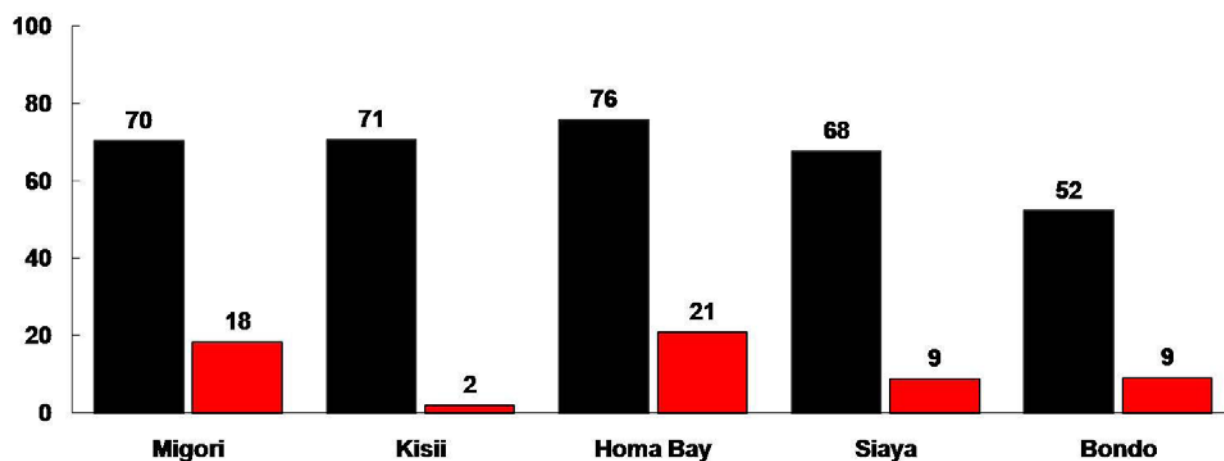
Figure 1.2: Percentage of Indians practising open defecation, by wealth quintile, in 2005/06.

has said, “MDG goals simply represent achievable levels if countries commit the resources and power to accomplish them. *They do not necessarily represent acceptable levels of service*” [emphasis added].<sup>[4]</sup>

The United Nations Human Settlements Programme (UN-Habitat) has done some ground-breaking research on what it terms 'adequate' sanitation and water supplies. The definitions used by UN-Habitat are:<sup>[5]</sup>

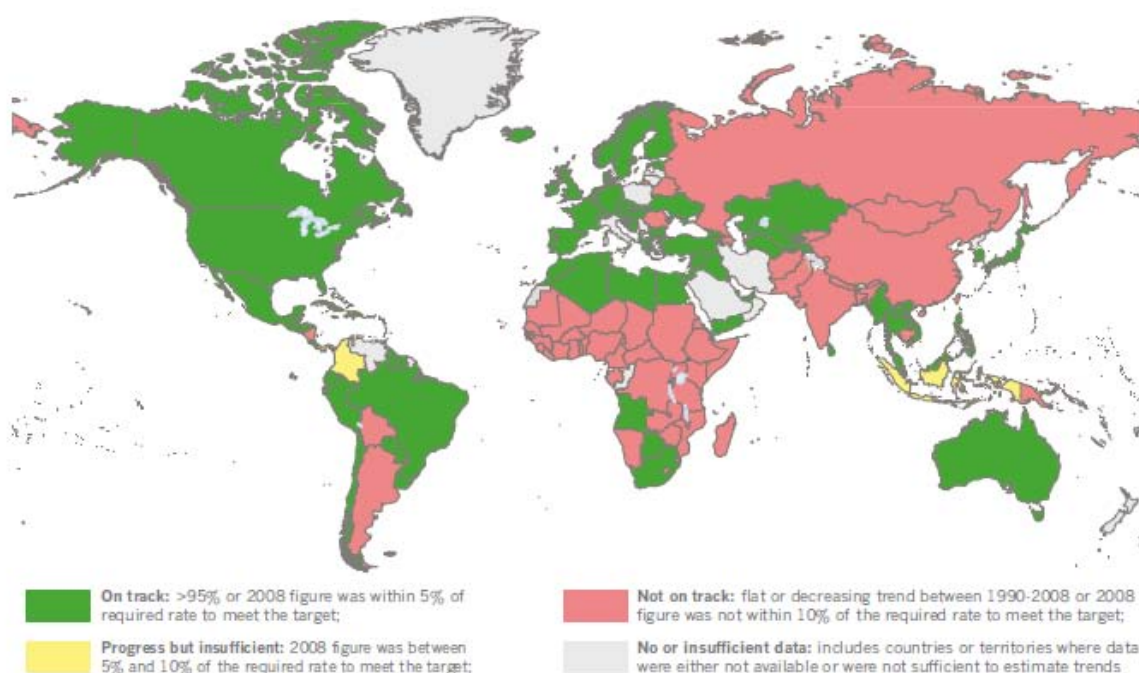
- **Adequate sanitation:** "access to sanitation that is convenient for all household members, affordable, and that eliminates contact with human excreta and other wastewater in the home and neighbourhood", and
- **Adequate water supply:** "a supply of water that is safe, sufficient, regular, convenient, and available at an affordable price".

In five towns in western Kenya in 2006 access to 'improved' water supplies appeared to be quite good (52–76%) but when households were excluded because they had less than 20 litres of water per person per day (lpd), they spent more than 10% of household income on water, and they spent more than 60 minutes per day collecting water, access to 'adequate' water supplies fell dramatically to 2–21% (Figure 1.3).<sup>[6]</sup> Thus 'improved' is a long way from 'adequate' – and you could argue that people should have  $\geq 30$  lpd, not  $\geq 20$ ; that they should spend  $\leq 5\%$  of their income on water, not  $\leq 10\%$ ; and that they should spend  $\leq 30$  minutes a day collecting water, not  $\leq 60$  – in which case access to an 'adequate' water supply would be even lower than shown in the figure.

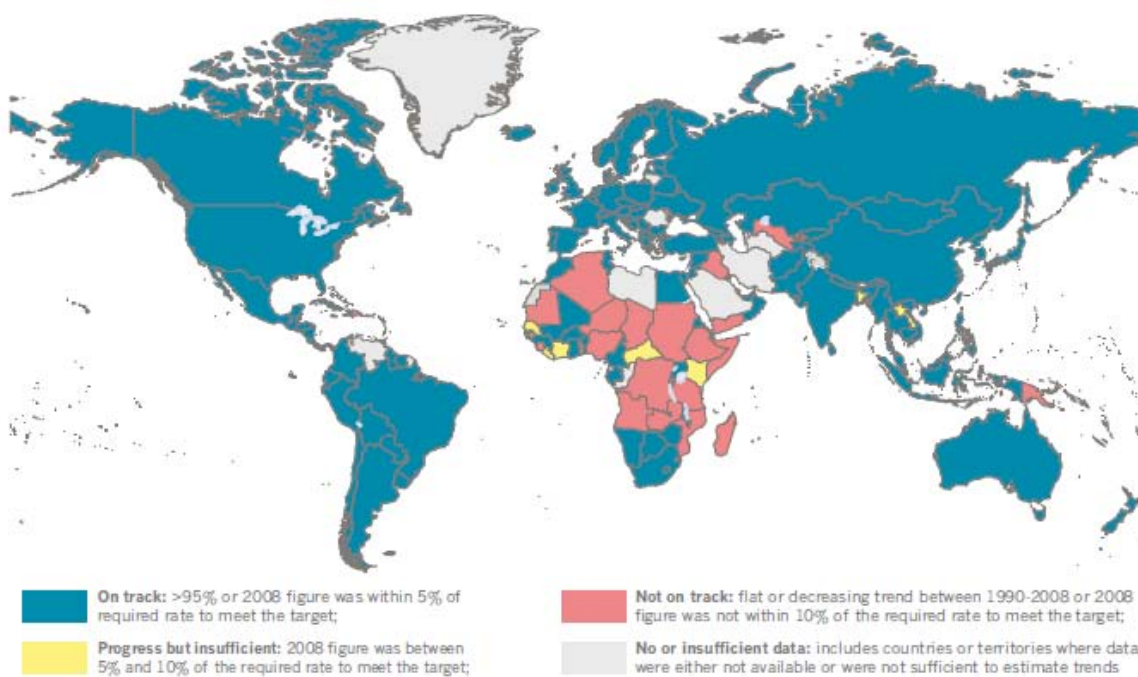


**Figure 1.3:** Percentage of the populations in five towns in western Kenya with access to an 'improved' water supply (black) and with access to an 'adequate' water supply (red), with 'improved' defined as in Table 1.1 and 'adequate' defined as  $\geq 20$  litres of water per person per day,  $\leq 10\%$  of household income spent on water, and  $\leq 1$  hour spent per day collecting water.

As might be expected, most of the countries that are not on-track to meet the MDG sanitation target are in Sub-Saharan Africa and Asia (Figure 1.4), and almost all of those not on-track to meet the MDG water-supply target are in Sub-Saharan Africa (Figure 1.5). As noted in a recent WaterAid report, if the current rate of progress is not increased, then Africa will meet the sanitation target not by the end of 2015, but only by the end of 2084.<sup>[7]</sup>



**Figure 1.4:** Countries on-track and off-track, as of 2008, to meet the MDG improved sanitation target.<sup>[1]</sup>



**Figure 1.5:** Countries on-track and off-track, as of 2008, to meet the MDG improved water supply target.<sup>[1]</sup>

## 1.2 Disease, Stunting and Cognitive Impairment

Poor sanitation and poor water supplies cause disease and death. In 2000 poor hygiene, poor sanitation and poor water supplies, taken together, caused 4% of all deaths in the world and were responsible for 5.7% of the total global burden of disease.<sup>[8]</sup> Malnutrition is the only greater risk factor.

### 1.2.1 Infant and child mortality and life expectancy at birth

Infant mortality rate (IMR) is the number of babies who die before their first birthday, expressed per 1000 live births (‰), and child mortality rate (U5MR) is number of children who die before their fifth birthday, again expressed per 1000 live births. In industrialized countries in 2008 the IMR was 5‰ and the U5MR 6‰. The corresponding figures for developing countries were 49‰ and 72‰, respectively; and for the least developed countries<sup>1</sup> 82‰ and 129‰.<sup>[9]</sup> In 2006 four countries had U5MRs  $\geq 200\%$  (i.e.,  $\geq 20$  percent of children did not make their fifth birthday): Afghanistan (257‰), Angola (220‰), Chad (209‰) and the Democratic Republic of the Congo (200‰).

Life expectancy at birth (LEB) is the number of years newborn children would live if subject to the mortality risks prevailing for the cross section of population at the time of their birth. LEB in 2008 in industrialized countries was 80

1 The least developed countries are Afghanistan, Angola, Bangladesh, Benin, Bhutan, Burkina Faso, Burundi, Cambodia, Central African Republic, Chad, Comoros, Democratic Republic of the Congo, Djibouti, Equatorial Guinea, Eritrea, Ethiopia, Gambia, Guinea, Guinea-Bissau, Haiti, Kiribati, Lao People’s Democratic Republic, Lesotho, Liberia, Madagascar, Malawi, Maldives, Mali, Mauritania, Mozambique, Myanmar, Nepal, Niger, Rwanda, Samoa, Sao Tome and Principe, Senegal, Sierra Leone, Solomon Islands, Somalia, Sudan, Timor-Leste, Togo, Tuvalu, Uganda, United Republic of Tanzania, Vanuatu, Yemen, and Zambia

Please click the advert

**See the light!**  
**The sooner you realize we are right,  
 the sooner your life will get better!**

A bit over the top? Yes we know!  
 We are just that sure that we can make your  
 media activities more effective.



Get "Bookboon's Free Media Advice"  
 Email [kbm@bookboon.com](mailto:kbm@bookboon.com)













years, in developing countries 67 years, and in the least developed countries 57 years. The five countries with the lowest LEBs in 2008 were Zimbabwe (44 years), Zambia and Lesotho (45 years), and Mali and Nigeria (48 years) [these low LEBs are mainly due to the large number of AIDS-related deaths in these countries].<sup>[9]</sup>

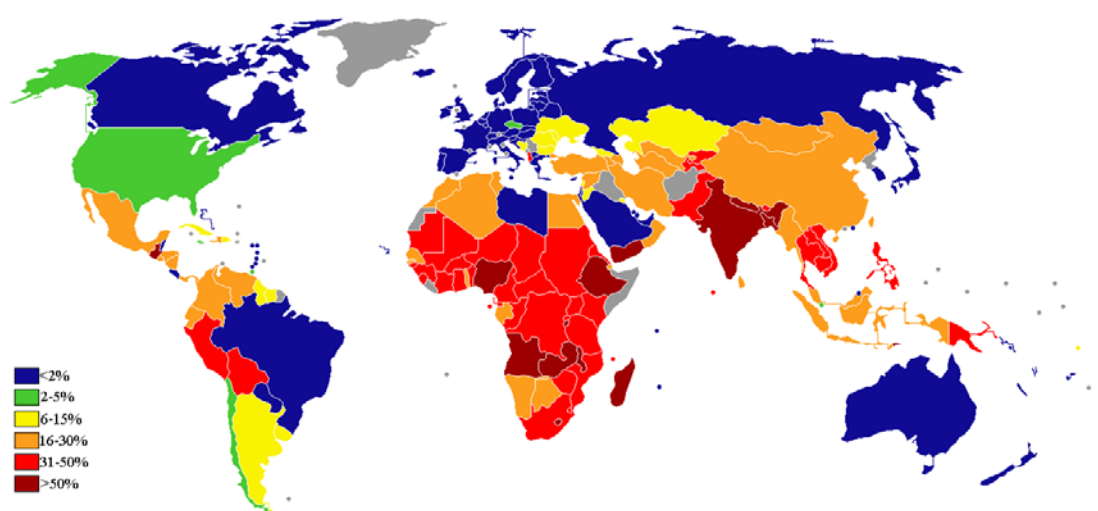
There are many reasons why poor babies and children die young and poor adults die at an early age. The main reason is that they are poor and, because they are poor, they have poor sanitation and poor water supplies, and also insufficient food. They thus have a high incidence of water- and excreta-related diseases (discussed in Chapter 2). Diarrhoeal diseases, for example, are extremely common (Table 1.2),<sup>[10]</sup> and they kill around 1.3 million children under 5 every year.<sup>[11,12]</sup> Rotavirus alone kills around 400,000, and norovirus around 200,000, under-5s every year. Most of these deaths are in developing countries: 40% occur in Sub-Saharan Africa at a rate of around 2,200 under-5 deaths per day.

**Table 1.2:** Diarrhoeal disease (DD) incidence per person in 2000 by region and age<sup>[10]</sup>

World region	DD incidence in all ages	DD incidence in the under-5s	DD incidence in the over-5s
Industrialized countries	0.2	0.2–1.7	0.1–0.2
Developing countries	0.8–1.3	2.4–5.2	0.4–0.6
World average	0.7	3.7	0.4

### 1.2.2 Stunting

Stunting, or low height-for-age, is mainly a manifestation of malnutrition. It is a common condition in many developing countries (Figure 1.6) where it is generally exacerbated by diarrhoeal diseases and helminthiases (worm infections – see Chapter 2). For example, in a 10-year study of 119 slum children in northeast Brazil, children who had had a high burden (~9 episodes) of diarrhoeal disease in their first two years of life were on average 3.6 cm shorter at age 7 than other children, and those children who had also had an early childhood helminthiasis were on average a further 4.6 cm shorter at the same age.<sup>[13]</sup>



**Figure 1.6:** World map showing the percentage of children under 5 with low height-for-age.<sup>[14]</sup>

### 1.2.3 Cognitive impairment

Early childhood diarrhoeal diseases and helminthiases, most often in conjunction with malnutrition, result in a loss of cognition in older childhood – the areas most affected are verbal fluency, short-term memory and speed of information processing, which are precisely the areas most needed for people to be able to contribute to socio-economic development.<sup>[13, 15–17]</sup> As a consequence productivity in adult life is less than optimal. Furthermore children with more than one helminthic infection experience worse cognitive outcomes than those with only one.<sup>[18]</sup>

### 1.3 Personal Safety and Dignity

Not having household-level sanitation facilities means that women and girls, particularly adolescent girls, are at risk from violence (assault, rape) when they go out, especially at night, to a communal sanitation facility or to defecate in the open.<sup>[19]</sup> This deeply affects the personal dignity of everyone, but especially women and adolescent girls:<sup>[20]</sup>

*“Women and girls can be forced to wait until nightfall to defecate, if there are no suitable sanitation facilities for them to use in the daytime. ... Restricted toilet opportunities increase the chance of urinary tract infection and chronic constipation as well as causing psychological stress. It also makes women vulnerable to violence if they are forced to defecate early in the morning or after nightfall, in secluded areas, sometimes risking rape and sexual and physical assault. With access to appropriate toilets, women and girls can use them at any time, in private, without shame, embarrassment or fear. Making defecation less of a problem is a liberating development for women, whose lives can be dominated by this basic need.”*

“Water is Life, Sanitation is Dignity” – so: no sanitation, no privacy, no dignity.<sup>[21]</sup>

### 1.4 Solutions to the Crisis

There *are* good, low-cost engineering interventions to solve the global sanitation and water-supply crisis. For engineers to implement such interventions means that they must:

- Understand the environmental transmission pathways of water- and excreta-diseases (Chapter 2),
- and be able to:
- Design appropriate low-cost sanitation systems in urban and rural areas (Chapter 3),
- Design appropriate low-cost water-supply systems in urban and rural areas (Chapter 4),
- Plan low-cost sanitation and water-supply programmes and projects in an effective and all-inclusive manner (Chapter 5), and
- Arrange project financing and develop appropriate pricing mechanisms for low-cost sanitation and water-supply systems in urban and rural areas (Chapter 6).

## References

1. *Progress on Sanitation and Drinking-water: 2010 Update*, World Health Organization & UNICEF, Geneva, 2010; available online at: [http://www.who.int/water\\_sanitation\\_health/publications/9789241563956/en/index.html](http://www.who.int/water_sanitation_health/publications/9789241563956/en/index.html).
2. *India's Sanitation for All: How to Make it Happen*, Asian Development Bank, Manila, 2009; available online at: [http://www.adb.org/Documents/Books/Water\\_for\\_All\\_Series/Indian-Sanitation/Indian-Sanitation.pdf](http://www.adb.org/Documents/Books/Water_for_All_Series/Indian-Sanitation/Indian-Sanitation.pdf).
3. UN Millennium Project, webpage at: <http://www.unmillenniumproject.org/index.htm>; details of the MDG sanitation and water targets (Target #10, Goal #7) are at: <http://www.unmillenniumproject.org/goals/gti.htm#goal7>.
4. *Sanitation in India: Progress, Differentials, Correlates, and Challenges*, Asian Development Bank, Manila, 2009; available online at: <http://www.adb.org/Documents/South-Asia/Occasional-Paper/India-Sanitation/default.asp>.
5. *Water and Sanitation in the World's Cities: Local Action for Global Goals*, Earthscan, London, 2003.
6. UN-Habitat, unpublished data.
7. *From Commitments to Action – Progress on Implementing eThekweni in Eastern Africa*, WaterAid, London, 2009; available online at: [http://www.wateraid.org/documents/plugin\\_documents/estafricatrafliclights.pdf](http://www.wateraid.org/documents/plugin_documents/estafricatrafliclights.pdf) [“eThekweni” here refers to the eThekweni Declaration made at AfricaSan2008 held in Durban, South Africa, in February 2008 – see: <http://www.wsp.org/UserFiles/file/eThekweniAfricaSan.pdf>].
8. A Prüss, D Kay, L Fewtrell & J Bartram, Estimating the burden of disease from water, sanitation, and hygiene at a global level, *Environmental Health Perspectives* 2002, **110** (5), 537–542; available online at: [http://www.who.int/quantifying\\_ehimpacts/global/en/ArticleEHP052002.pdf](http://www.who.int/quantifying_ehimpacts/global/en/ArticleEHP052002.pdf).
9. *State of the World's Children 2009: Statistical Tables for 2009*, UNICEF, New York; available online at: <http://www.unicef.org/rightsite/sowc/statistics.php>.

Please click the advert

**I WANT TO CHANGE DIRECTION,  
AND THE WORLD.**

**GOT-THE-ENERGY-TO-LEAD.COM**

We believe that energy suppliers should be renewable, too. We are therefore looking for enthusiastic new colleagues with plenty of ideas who want to join RWE in changing the world. Visit us online to find out what we are offering and how we are working together to ensure the energy of the future.

**RWE**  
The energy to lead

Download free ebooks at [bookboon.com](http://bookboon.com)



10. *Global Burden of Disease 2000 – Version 2: Methods and Results*, World Health Organization, Geneva, 2002; available online at: <http://www.who.int/healthinfo/paper50.pdf>.
11. C Boschi-Pinto, L Velebit & K Shibuyac, Estimating child mortality due to diarrhoea in developing countries, *Bulletin of the World Health Organization* 2006, **86**, 710–717; available online at: <http://www.who.int/bulletin/volumes/86/9/07-050054.pdf>.
12. RE Black, S Cousens, HL Johnson, JE Lawn, I Rudan and others, Global, regional, and national causes of child mortality in 2008: a systematic analysis, *The Lancet* 2010, 375, 1969–1987; available online at: [http://www.doi.org/10.1016/S0140-6736\(10\)60549-1](http://www.doi.org/10.1016/S0140-6736(10)60549-1).
13. DS Berkman, AG Lescano, RH Gilman, SL Lopez & MM Black, Effects of stunting, diarrhoeal disease, and parasitic infection during infancy on cognition in late childhood: a follow-up study, *The Lancet* 2002, **359**, 564–571; available online at: <http://www.thelancet.com/journals/lancet/article/PIIS0140673602077449/abstract>.
14. *World Health Statistics 2008*, World Health Organization, Geneva, 2008; available online at: <http://www.who.int/whosis/whostat/2008/en/index.html>.
15. SR Moore, AAM Lima, MR Conaway et al., Early childhood diarrhoea and helminthiasis associated with long-term linear growth faltering, *International Journal of Epidemiology* 2001, **30**, 1457–1464; available online at: <http://ije.oxfordjournals.org/cgi/reprint/30/6/1457>.
16. Partnership for Child Development, Heavy schistosomiasis associated with poor short-term memory and slower reaction times in Tanzanian schoolchildren, *Tropical Medicine & International Health* 2002, **7**, 104–117; available online at: <http://www3.interscience.wiley.com/cgi-bin/fulltext/118926706/PDFSTART>.
17. C Eppig, CL Fincher & R Thornhill, Parasite prevalence and the worldwide distribution of cognitive ability, *Proceedings of the Royal Society B* (in press); abstract available online at: <http://www.doi.org/10.1098/rspb.2010.0973>.
18. A Jardim-Botelho, SS Raff, R de Ávila Rodrigues et al., Hookworm, *Ascaris lumbricoides* infection and polyparasitism associated with poor cognitive performance in Brazilian schoolchildren, *Tropical Medicine & International Health* 2008, **13**, 994–1004; abstract available online at: <http://www3.interscience.wiley.com/journal/120747688/abstract>.
19. *Insecurity and Indignity: Women's Experiences in the Slums of Nairobi, Kenya*, Amnesty International Publications, London, 2010; available online at: <http://www.amnesty.org/en/library/info/AFR32/002/2010/en>.
20. *For Her It's the Big Issue: Putting Women at the Centre of Water Supply, Sanitation and Hygiene*, Water Supply and Sanitation Collaborative Council, Geneva, 2006; available online at: [http://www.wsscc.org/fileadmin/files/pdf/publication/FOR\\_HER\\_ITs\\_THE\\_BIG\\_ISSUE\\_Evidence\\_Report-en.pdf](http://www.wsscc.org/fileadmin/files/pdf/publication/FOR_HER_ITs_THE_BIG_ISSUE_Evidence_Report-en.pdf).
21. *Health, Dignity, and Development: What will it Take?* Task Force on Water and Sanitation, UN Millennium Development Project, United Nations, New York, 2006; available online at: [http://www.unmillenniumproject.org/reports/tf\\_watersanitation.htm](http://www.unmillenniumproject.org/reports/tf_watersanitation.htm).

## Chapter 1: Key Messages

1. In 2008, out of a world population of nearly 6,600 million people, around 2,560 million were without access to 'improved' sanitation and around 860 million were without access to an 'improved' water supply. Most of those lacking improved sanitation are in Sub-Saharan Africa and Asia, and most of those lacking improved water supplies are in Sub-Saharan Africa.
2. The definitions used by WHO and UNICEF for 'improved' sanitation and 'improved' water supplies are based simply on access to specified technologies. The definitions used by UN-Habitat for 'adequate' sanitation and 'adequate water supplies are much more appropriate as they include satisfactory operation and affordability.
3. The MDG sanitation and water-supply targets are only to reduce by half the proportion of people without access to improved sanitation and improved water supplies, taking 1990 as the base year. The only meaningful target is universal coverage – that is, Adequate Sanitation and Water Supplies for All.
4. Poor sanitation and poor water supplies lead to a high incidence of water- and excreta-related diseases (detailed in Chapter 2), and these diseases result in high infant and under-5 mortality rates and a low life-expectancy-at-birth. Physical and cognitive impairment result from high incidences of these diseases. This can then lead to decreased productivity in adult life – precisely the opposite of what is needed for good socio-economic development.

## 2 Water- and Excreta-related Diseases

### 2.1 Introduction

If people do not have a good water supply or access to a good sanitation facility, their health will suffer. In particular, as noted in Section 1.2, they will have one or more of the water- and excreta-related diseases and as a result they may die, be seriously ill, or suffer physical and/or cognitive impairment. It is very important for engineers to have a good understanding of the relationship between sanitation, water and health – i.e., to understand the water- and excreta-related diseases, so that they can design efficient and cost-effective engineering interventions (sanitation and water-supply improvements) which prevent, or at least minimize, their environmental transmission. Historically engineers have been very good at doing this: thanks to the piped water supplies and sewerage installed in late 19th and early 20th centuries in towns and cities of the then industrializing world, the incidence of Water and excreta related diseases in the now industrialized countries is very low – and, as a result of this, it can safely be said that engineers have saved more lives than medical doctors ever have or ever will. However, the current sanitation and water-supply crisis in low-income countries means that engineers and other professionals (behavioural scientists, hygiene specialists, social anthropologists, specialists in public health medicine) have a vast amount of work to do to provide poor people in low-income countries with good sanitation and water supplies – to improve both their health and their quality of life.

Please click the advert

### Who is your target group? And how can we reach them?

At Bookboon, you can segment the exact right audience for your advertising campaign.

Our eBooks offer in-book advertising spot to reach the right candidate.



Contact us to hear more  
[kbm@bookboon.com](mailto:kbm@bookboon.com)



CREDIT SUISSE

DAIMLER



Microsoft

[bookboon.com](http://bookboon.com)

Download free ebooks at [bookboon.com](http://bookboon.com)

## 2.2 The Global Health Impact of Water and excreta related diseases

Unsafe water, sanitation and hygiene, which together are the main cause of Water and excreta related diseases throughout the world, but principally in low- and middle-income countries, have a huge adverse health impact – for example, in low- and middle-income countries in 2004:<sup>[1]</sup>

- **Mortality:** unsafe water, unsafe sanitation, and poor personal and domestic hygiene were responsible for ~1.6 million deaths, of which ~1.4 million were of children under the age of 5 due mainly to diarrhoeal diseases [in high-income countries the corresponding number of deaths was ~4,000]; and
- **Burden of disease:** unsafe water, sanitation, and hygiene were responsible for a total burden of disease of ~57 million disability-adjusted life years lost (DALYs – see Box 2.1 for an explanation of DALYs) [in high-income countries the corresponding burden of disease was just under 300,000 DALYs].

## 2.3 Environmental Classification of Water and excreta related diseases

### 2.3.1 Why an *Environmental* Classification?

Why do we need an *environmental* classification of Water and excreta related diseases? Simply because we are not medical doctors and so lists of diseases related to defects in sanitation and water supplies, either an alphabetical list or one that groups the diseases according to the biological type of the organisms causing the diseases (i.e., viral, bacterial, protozoan and helminthic diseases – helminths are worms), are just not meaningful to us. What

**Box 2.1: Disability-adjusted Life Year (DALY) Losses**

The various hazards that can be present in water can have very different health outcomes. Some outcomes are mild (e.g., diarrhoea), while others can be severe (cholera, haemolytic uraemic syndrome associated with *E. coli* O157, or cancer); some are acute (diarrhoea), while others are delayed (infectious hepatitis, cancer); some especially relate to certain age ranges and groups (skeletal fluorosis in older adults often arises from long-term exposure to high levels of fluoride in childhood; infection with hepatitis E virus has a very high mortality rate among pregnant women). In addition, any one hazard may cause multiple effects (e.g., gastroenteritis, Gullain-Barré syndrome, reactive arthritis and mortality associated with *Campylobacter*).

In order to support public health priority setting a common metric is required that can be applied to all types of hazard and takes into account different health outcomes including probabilities, severities and durations of effects. Disability-adjusted Life Years (DALYs) provides this metric. The basic principle of the DALY is to weight each health impact in terms of severity within the range of 0 for good health to 1 for death. The weighting is then multiplied by duration of the effect and the number of people affected. In the case of death duration is regarded as the years lost in relation to normal life expectancy (taken as 70 years). Using this approach a mild diarrhoea with a severity weighting of 0.1 and lasting for 7 days results in a DALY loss of  $[(0.1 \times 7)/365]$  – i.e., 0.002; while death resulting in a loss of 30 years of life equates to a DALY loss of 30. [Strictly speaking DALY losses have units of years, but generally they are just expressed as a number.]

Hence, DALYs = YLL (years of life lost) + YLD (years lived with a disability or illness) – in this context disability refers to conditions that detract from good health.

*Calculation of DALY losses*

Infection with rotavirus (in developed countries), for example, causes:

- mild diarrhoea (severity rating of 0.1) lasting 7 days in 97.5% of cases
- severe diarrhoea (severity rating of 0.23) lasting 7 days in 2.5% of cases
- the death (severity rating of 1) of very young children in 0.015% of cases

The DALY loss per case of rotavirus diarrhoea is then:

$$\left( \frac{0.1 \times 7}{365 \times 0.975} \right) + \left( \frac{0.23 \times 7}{365 \times 0.025} \right) + (1 \times 70 \times 0.00015)$$

i.e., 0.0125 [years].

Infection with *Cryptosporidium* can cause watery diarrhoea (severity weighting of 0.067) lasting for 7 days with extremely rare deaths in 0.0001% of cases. This equates to a DALY loss per case of cryptosporidiosis of 0.0015 [years].

Source: WHO.<sup>[2]</sup>

we, as engineers, need is an environmental classification as this groups the diseases into several categories, in each of which the environmental transmission pathways of the disease-causing organisms (the ‘pathogens’) are the same or very similar, and so an engineering intervention (e.g., a sanitation or water-supply improvement) against the transmission of one disease in a particular category will be equally effective against the transmission of all the other diseases in that category. Thus fully understanding the environmental classification of Water and excreta related diseases enables us engineers to design engineering interventions (i.e., sanitation and water-supply improvements) to be highly effective against the environmental transmission of Water and excreta related diseases.

### 2.3.2 Environmental Classifications

An environmental classification of water-related disease was developed by Professor David Bradley (of the London School of Hygiene and Tropical Medicine – LSHTM) when he was working in East Africa in the late 1960s,<sup>[3]</sup> and an environmental classification of excreta-related diseases was developed by Professor Sir Richard Feachem (now of the University of California San Francisco) and colleagues at LSHTM in the late 1970s.<sup>[4]</sup> What is presented in Table 2.1 is a unitary environmental classification of both water- and excreta-related diseases.<sup>[5]</sup> Details of all the diseases mentioned in the table are available on the websites of the Centres for Disease Control and Prevention and the World Health Organization;<sup>[7,8]</sup> online search engines also readily provide disease information.

Some of these diseases and their environmental transmission pathways are more important than others in the sense that they cause more illnesses and/or more deaths (or, as medical doctors and epidemiologists would say, they cause greater morbidity and/or mortality), and these are detailed below.

Please click the advert



**THE BEST MASTER  
IN THE NETHERLANDS**

**Master of Science  
in Management\***



Source: ‘Keuzegids Higher Education Masters 2011’.  
\*In category business administration and accountancy & controlling.

 **NYENRODE**  
BUSINESS UNIVERSITEIT

**www.nyenrode.nl**

*Important environmental transmission pathways for water-related diseases***(a) Waterborne diseases**

Waterborne diseases are caused by a pathogen present *in* drinking water (or water used for drinking – hundreds of millions of people in developing countries drink contaminated water). If a sufficient number of a pathogen is ingested, then the disease it causes becomes established in the person or persons drinking the water. The waterborne transmission route was first demonstrated by Dr John Snow in Soho, London during the cholera epidemic of 1854 (Box 2.1).<sup>[9]</sup>

The largest outbreak of a waterborne disease – cryptosporidiosis – occurred in Milwaukee, Wisconsin during March-April 1993 due to a malfunction at one of the city's water treatment plants.<sup>[10]</sup> A total of ~403,000 people, around a quarter of the population of Greater Milwaukee, became ill. The total cost of the outbreak was estimated to be US\$ 96.3 million (\$31.7 million in medical costs and \$64.6 million in productivity losses; 1993 \$).<sup>[11]</sup>

**(b) Water-washed diseases**

Water-washed diseases are caused by a lack of adequate volumes of water – water for drinking but also, and more importantly, water for personal and domestic hygiene. If people do not have sufficient water to keep themselves and their house, especially their kitchen (or food preparation and cooking area) clean, they will have skin and eye diseases (such as scabies and trachoma – trachoma is the leading cause of preventable blindness<sup>[12]</sup>), and diarrhoea, dysentery – in fact any of the diseases that can be waterborne. This is because both waterborne and water-washed diseases (other than the skin and eye infections) have the same basic transmission pathway: the pathogens have to get from the anus of one person into the mouth of another person – i.e., they are both faeco-oral diseases (Category A in Table 2.1).

Water-washed faeco-oral diseases have very direct person-to-person transmission routes, whereas waterborne faeco-oral diseases have a much less direct transmission route (Box 2.2). This raises an important question:

**Is it better to increase water quality or to increase water quantity?**

In an ideal world both water-quality improvements (i.e., removing pathogens from drinking water by water treatment – filtration and disinfection, for example) and water-quantity improvements would be

**Table 2.1:** Unitary environmental classification of water-and excreta-related diseases

Category	Environmental transmission features	Disease examples	Control strategies
<b>A. Faeco-oral waterborne and water-washed diseases</b>	Non-latent (except <i>Ascaris</i> and guinea worm) No intermediate host Infectivity: medium to low (bacteria), high (others) Persistence: medium to high (bacteria), low to medium (others, except <i>Ascaris</i> : very high) Able (bacteria) and unable (others) to multiply outside host	<p><b>Viral:</b></p> <p>Hepatitis A, E, and F</p> <p>Poliomyelitis</p> <p>Rotaviral diarrhoea</p> <p>Noroviral diarrhoea</p> <p>Adenoviral diarrhoea</p> <p><b>Bacterial:</b></p> <p>Campylobacteriosis</p> <p>Cholera</p> <p><i>Helicobacter pylori</i> infection</p> <p>Salmonellosis</p> <p>Typhoid and paratyphoid fevers</p> <p>Yersiniosis</p> <p><b>Protozoan:</b></p> <p>Amebiasis</p> <p>Cryptosporidiosis</p> <p><i>Cyclospora cayetanensis</i> diarrhoea</p> <p><i>Enterocytozoon bienusi</i> diarrhoea</p> <p>Giardiasis <i>Isospora belli</i> diarrhoea</p> <p><b>Helminthic:</b></p> <p>Ascariasis</p> <p>Enterobiasis</p> <p>Hymenolepiasis</p> <p>Guinea worm infection</p>	<p>Improve water quality, availability, and reliability (water-washed disease control)</p> <p>Improve water quality (waterborne disease control)</p> <p>Hygiene education</p>
<b>B. Non-faeco-oral water-washed diseases</b>	Non-latent No intermediate host High infectivity Medium to high persistence Unable to multiply	<p>Skin infections (scabies, leprosy, yaws)</p> <p>Eye infections (trachoma, conjunctivitis, including that caused by <i>Encephalitozoon hellem</i>)</p> <p>Louse-borne fevers</p>	<p>Improve water quantity, availability, and reliability</p> <p>Hygiene education</p>
<b>C. Geohelminthiases</b>	Latent Very persistent Unable to multiply No intermediate host Very high infectivity	<p>Ascariasis</p> <p>Trichuriasis</p> <p>Hookworm infection</p>	<p>Sanitation</p> <p>Effective treatment of excreta or wastewater prior to reuse</p> <p>Hygiene education</p>



<b>D. Taeniasis</b>	Latent Persistent Able to multiply Very high infectivity Cow or pig intermediate host	Beef and pork tapeworm infections	As C above, plus proper cooking of meat and improved meat inspection Food hygiene education
<b>E. Water-based diseases</b>	Latent Persistent Able to multiply High infectivity Intermediate aquatic host(s)	<p><b>Bacterial:</b>                  Leptospirosis                  Tularemia                  Legionellosis</p> <p><b>Helminthic:</b>                  Schistosomiasis                  Clonorchiasis                  Fasciolopsiasis                  Guinea worm infection</p> <p><b>Fungal:</b>                  Pulmonary hemorrhage due to <i>Stachybotrys atra</i> infection</p>	Decrease contact with contaminated water; improve domestic plumbing Public education  Decrease contact with contaminated waters; sanitation; treatment of excreta or wastewater prior to aquacultural reuse Public education  Drying of flood-damaged homes Public education

Please click the advert

## Do your employees receive the right training?

Bookboon offers an eLibrary with a wide range of Soft Skill training & Microsoft Office books to keep your staff up to date at all times.



Contact us to hear more  
[kbm@bookboon.com](mailto:kbm@bookboon.com)










<b>F. Insect-vector diseases</b>	<i>Water-related:</i>	
	Malaria	Decrease passage through breeding sites; destroy breeding sites; larvicide application; biological control; use of mosquito netting and impregnated bed nets
	Dengue	
	Rift Valley fever	
	Japanese encephalitis	
	Yellow fever	
	African sleeping sickness	
	Onchocerciasis	
	<i>Excreta-related:</i>	Food and domestic hygiene education
	Fly-borne and cockroach-borne excreted infections <sup>a</sup>	Improve stormwater drainage
Bancroftian filariasis	Public education	
<b>G. Rodent-vector diseases</b>	Rodent-borne excreted infections <sup>a</sup>	Rodent control; hygiene education; decreased contact with contamin-ated water
	Leptospirosis	
	Tularemia	
		Public education

<sup>a</sup>The excreted infections comprise all diseases in Categories A, C, and D and the helminthic diseases in Category E.

Source: Mara & Feachem;<sup>[5]</sup> category G was added by Mara & Alabaster.<sup>[6]</sup>

made. But in rural areas of developing countries, which are generally far removed from any ideal world, there is typically not the money to do both, so the question has to be answered – and the answer is that water quantity should be increased first since most faeco-oral disease transmission occurs via the water-washed route, not the waterborne route, especially in communities with inadequate water supplies (of which there are many – see section 1.1). There is also the huge problem of correctly operating and maintaining water treatment plants (even very simple ones) in rural areas, particularly getting supplies of disinfectants – typically chlorine – to the treatment plant on time).

**Box 2.2: The Broad Street Pump – London, 1854**

“The most terrible outbreak of cholera which ever occurred in this kingdom, is probably that which took place in Broad Street, Golden Square, and the adjoining streets, a few weeks ago. Within two hundred and fifty yards of the spot where Cambridge Street joins Broad Street, there were upwards of five hundred fatal attacks of cholera in ten days. The mortality in this limited area probably equals any that was ever caused in this country, even by the plague; and it was much more sudden, as the greater number of cases terminated in a few hours. The mortality would undoubtedly have been much greater had it not been for the flight of the population: ... in less than six days from the commencement of the outbreak, the most afflicted streets were deserted by more than three-quarters of their inhabitants.

There were a few cases of cholera in the neighbourhood of Broad Street, Golden Square, in the latter part of August; and the so-called outbreak, which commenced in the night between the 31st August and the 1st September was, as in all similar instances, only a violent increase of the malady. As soon as I became acquainted with the situation and extent of this irruption of cholera, I suspected some contamination of the water of the much-frequented street pump in Broad Street, near the end of Cambridge Street. ... On proceeding to the spot, I found that nearly all the deaths had taken place within a short distance of the pump. ... The result of the inquiry then was, that there had been no particular outbreak or increase of cholera, in this part of London, except among the persons who were in the habit of drinking the water of the above-mentioned pump-web. I had an interview with the Board of Guardians of St. James’s parish, on the evening of Thursday, 7th September, and represented the above circumstances to them. In consequence of what I said, the handle of the pump was removed on the following day.”

John Snow, *On the Mode of Communication of Cholera*, 1855.<sup>[9]</sup>

**Box 2.3: Transmission routes of faeco-oral diseases**

Faeco-oral diseases occur when a sufficient number of a pathogen in the faeces of one person enters the mouth of another person. Likely transmission routes are:

1. Faeces of person A → fingers of person A → mouth of person B (imagine two very small children playing: they commonly put their fingers into each other’s mouths),
2. Faeces of person A → fingers of person A → fingers of person B → mouth of person B (two people shaking hands),
3. Faeces of person A → fingers of person A → food → mouths of persons B, C, D, etc. (a mother preparing food for her family), and
4. Faeces of person A → water → mouths of persons B, C, D, etc.

Routes #1–3 are examples of the very direct person-to-person water-washed transmission route, and route #4 is the waterborne route.

In poor communities with inadequate water supplies routes #1–3 are likely to occur much more frequently than route #4. This is not to say that waterborne diseases are unimportant, but just that water-washed diseases are more important.

*Important environmental transmission pathways for excreta-related diseases***(a) Faeco-oral diseases**

The faeco-oral diseases are a good example of diseases that are both water- and excreta-related. It might appear best to control them by the provision of sanitation to isolate people from their excreta; however, because faeco-oral diseases are most commonly spread by the water-washed transmission route, the provision of an adequate water supply, together with hygiene promotion – especially the promotion of hand-washing with soap, is more important than sanitation (this does not mean that sanitation is unimportant, just that an adequate water supply and good hygiene are more important).

**(b) Geohelminthiases**

These are the diseases caused by the soil-transmitted helminths (or worms) (Category C in Table 2.1). The four main geohelminths are *Ascaris lumbricoides*, the large human roundworm (Figure 2.1); *Trichuris trichiura*, the human whipworm; and *Ancylostoma duodenale* and *Necator americanus*, the two human hookworms – diagrams of the life cycles of these helminths are given on the website of CDC’s Division of Parasitic Diseases.<sup>[13]</sup> The geohelminthiases are extremely common infections: ~1.2 billion people have ascariasis, ~800 million have trichuriasis, and ~740 million have hookworm infection.<sup>[14]</sup> They are very common in periurban slums where it is not unusual for over 90% of the community to be infected with one or more of these worms. *Ascaris* is often the most common, due in part to the adult female worm producing ~200,000 eggs per day. Hookworms hook into the lining of the stomach and suck blood, so hookworm infection is particularly problematic for women of child-bearing age as the blood loss due to the hookworms can exceed that due to menstruation and this often leads to anaemia.

Please click the advert

www.job.oticon.dk

oticon  
PEOPLE FIRST



**Figure 2.1:** This 4-year old girl was given a worm-expellant drug and she excreted this very large number of *Ascaris* worms (each worm is about the size of a pencil).

**(c) Water-based helminthiases:**

These are the diseases caused by trematode worms that spend part of their life cycle in one or more intermediate aquatic hosts (Category E in Table 2.1). A good example is schistosomiasis (also called bilharzia), which infects 250–300 million people.<sup>[13]</sup> The eggs are voided in the faeces or urine (depending on the species of schistosome), they hatch in water and enter a freshwater snail (typically of the genus *Biomphalaria*). Massive asexual multiplication occurs in the snail from which thousands of ‘cercariae’ escape; these are the infective form of the worm and they have to find a human host within 48 hours (or they die); they penetrate the skin of anyone in the water (children playing in the water, women washing clothes in the water, men fishing in the water) and grow to adulthood in the body. The adult worms live in the portal veins near the liver and the eggs leave the body by boring through the bladder wall or the colon (depending on species) – over many years this causes cancer (section 2.2.4). Some eggs, however, end up in the liver where they are encapsulated; having just a few encapsulated schistosome eggs in the liver is not cause for major concern, but having many/very many encapsulated eggs in the liver means that the liver is not able to function well – and, if your liver is not able to function properly, then neither are you.

*Insect- and rodent-vector diseases*

The insect-vector diseases (Category F in Table 2.1) include several very important diseases such as malaria, yellow fever, dengue fever and lymphatic (Bancroftian) filariasis. Malaria kills nearly 1 million young children a year, mainly in Sub-Saharan Africa where it is responsible for 20% of child deaths.<sup>[15]</sup> Lymphatic filariasis, caused by the worm *Wuchereria bancrofti*, can be particularly unpleasant – in its clinical extreme it is known as elephantiasis, manifested by gross swelling of the genitalia and/or lower limbs (Figure 2.2); this is due to the adult worms blocking the lymphatic system so that it cannot drain.



**Figure 2.2: A case of elephantiasis.**

The principal rodent-vector disease (Category G in Table 2.1) is leptospirosis, caused by the bacterium *Leptospira interrogans*. It is primarily a disease of rats and the pathogen is shed in the rat's urine; people become infected when they come into contact with water contaminated with rat urine and if they have cuts or abrasions in their skin. The pathogen enters the body through the cut or abrasion and causes initially a mild flu-like fever which, if untreated, quickly turns to Weil's disease – failure of the liver and kidneys and, soon thereafter, death.

### 2.3.3 Water-related Cancers

It may seem counter-intuitive that certain cancers and water-related diseases are interrelated, but they are. The relationships between them closely follow Bradley's original environmental classification of water-related diseases, as shown in Table 2.2.<sup>[16]</sup> For example, in schistosomiasis-endemic countries bladder cancer occurring under the age of 50 is almost always due to chronic infection with *Schistosoma haematobium*, the eggs of which leave the body in the urine.<sup>[17]</sup>

**Table 2.2:** Environmental classification of water-related cancers

<b>Transmission mechanism</b>	<b>Agent</b>	<b>IARC classification<sup>a</sup></b>	<b>Associated carcinomas</b>
Waterborne	Arsenic	1	Skin, lung and liver cancers
	Radon	1	Lung cancer
Water-washed	Insufficient water <sup>b</sup>	–	Penile carcinoma
	<i>Helicobacter pylori</i>	1	Gastric cancer
Water-based	<i>Schistosoma haematobium</i>	1	Bladder cancer
	<i>S. japonicum</i>	2B	Colorectal cancer
	<i>Clonorchis sinensis</i>	2A	Bile duct cancer
Water-related insect vector	Epstein-Barr virus and malaria plasmodia	–	Burkitt's lymphoma

<sup>a</sup> Classifications of the International Agency for Research on Cancer ([www.iarc.fr](http://www.iarc.fr)):

- Group 1: known human carcinogen
- Group 2A: probable human carcinogen
- Group 2B: possible human carcinogen
- : not classified

<sup>b</sup> Insufficient water available or used for genital hygiene by uncircumcised men.

Please click the advert

## Is your recruitment website still missing a piece?

Bookboon can optimize your current traffic. By offering our free eBooks in your look and feel, we build a qualitative database of potential candidates.



Contact us to hear more  
[kbm@bookboon.com](mailto:kbm@bookboon.com)



CREDIT SUISSE

DAIMLER



Microsoft

[bookboon.com](http://bookboon.com)

## References

1. M Ezzati, S van der Hoorn, AD Lopez, G Danaei et al., Comparative quantification of mortality and burden of disease attributable to selected risk factors, in *Global Burden of Disease and Risk Factors* (ed. AD Lopez, CD Mathers, M Ezzati, DT Jamison & CJL Murray), pp. 241–396, Oxford University Press, New York, 2006; available online at: <http://files.dcp2.org/pdf/GBD/GBD04.pdf>.
2. *Health-based Targets*, World Health Organization, Geneva, 2010; available online at: [http://www.who.int/water\\_sanitation\\_health/WHS\\_WWD2010\\_health\\_targets\\_2010\\_8\\_en.pdf](http://www.who.int/water_sanitation_health/WHS_WWD2010_health_targets_2010_8_en.pdf).
3. GF White, DJ Bradley & AU White, *Drawers of Water: Domestic Water Use in East Africa*, University of Chicago Press, 1972.
4. RG Feachem, DJ Bradley, DD Mara & H Garelick, *Sanitation and Disease: Health Aspects of Excreta and Wastewater Management*, Wiley, Chichester, 1983; available online at: <http://www.personal.leeds.ac.uk/~cen6ddm/Sanitation&Disease.html>
5. DD Mara & RG Feachem, Water- and excreta-related diseases: unitary environmental classification, *Journal of Environmental Engineering, American Society of Civil Engineers* 1997, **125** (4), 334–339; available online at: <http://www.personal.leeds.ac.uk/~cen6ddm/pdfs%201972-1999/e41.pdf>.
6. DD Mara & GP Alabaster, An environmental classification of housing-related diseases in developing countries. *Journal of Tropical Medicine and Hygiene* 2005, **98** (1), 41–51; available online at: <http://www.personal.leeds.ac.uk/~cen6ddm/pdfs%201972-1999/e19.pdf>.
7. *Diseases & Conditions: A-Z Index*, CDC webpage at <http://www.cdc.gov/DiseasesConditions/>.
8. *Health Topics*, WHO webpage at <http://www.who.int/topics/en/>.
9. J Snow, *On the Mode of Communication of Cholera*, 2nd ed., John Churchill, London, 1855; available online at: <http://www.deltaomega.org/snowfin.pdf>.
10. WR MacKenzie, NJ Hoxie, ME Proctor, MS Gradus et al., A massive outbreak in Milwaukee of *Cryptosporidium* infection transmitted through the public water supply, *New England Journal of Medicine* 1994, **331** (3), 161–167; available online at: <http://content.nejm.org/cgi/content/full/331/3/161>.
11. PS Corso, MH Kramer, KA Blair, DG Addiss et al., Cost of illness in the 1993 waterborne *Cryptosporidium* outbreak, Milwaukee, Wisconsin, *Emerging Infectious Diseases* 2003, **9** (4), 426–431; available online at: <http://www.cdc.gov/ncidod/EID/vol9no4/pdfs/02-0417.pdf>.
12. <http://www.trachoma.org>.
13. Life cycles: *Ascaris*, <http://www.dpd.cdc.gov/dpdx/HTML/Ascariasis.htm>;  
*Trichuris*, <http://www.dpd.cdc.gov/dpdx/HTML/Trichuriasis.htm>;  
Hookworms: <http://www.dpd.cdc.gov/dpdx/HTML/Hookworm.htm>; and  
Schistosomes: <http://www.dpd.cdc.gov/dpdx/HTML/Schistosomiasis.htm>.
14. N de Silva, S Brooker, P Hotez, A Montresor et al., *Soil-Transmitted Helminthic Infections: Updating the Global Picture*, Working Paper No. 12, Disease Control Priorities Project, Washington, DC, 2003; available online at: <http://www.dcp2.org/diseases/5/ascariasis>.
15. <http://www.who.int/topics/malaria/en/>.
16. DD Mara & D Clapham, Water-related carcinomas: an environmental classification, *Journal of Environmental Engineering, American Society of Civil Engineers* 1997, **123** (5), 416–422; available online at: <http://www.personal.leeds.ac.uk/~cen6ddm/pdfs%201972-1999/e36.pdf>.
17. MH Mostafa, SA Sheweita & PJ O'Connor, Relationship between schistosomiasis and bladder cancer, *Clinical*



*Microbiology Reviews* 1999, **12** (1), 97–111; available online at: <http://cmr.asm.org/cgi/reprint/12/1/97>.

## Further Reading

### *Environmental Health and Child Survival: Epidemiology, Economics, Experiences*

This World Bank book, published in 2008, “shows that inadequate environmental health has huge costs to the economy (about 9 percent of the GDP of typical developing countries) in addition to the pain and suffering they cause. [It] shows how lack of investment will also negatively affect their children’s educational and cognitive performance, because of the effects of malnutrition, exacerbated by frequent episodes of illness.” Available online at: <http://go.worldbank.org/XNB44VJ9R0>.

### *Disease Control Priorities in Developing Countries*

The second edition of this book (‘DCP2’), published in 2006, “provides the results of in-depth research, offers insightful analyses, and proposes context-sensitive policy recommendations to significantly reduce the burden of disease in developing countries and to improve the quality of life for all people.” Available online at: <http://www.dcp2.org/pubs/DCP>.

### *Priorities in Health*

This companion volume to DCP2, also published in 2006, “distills the essence of DCP2 into a succinct and readable format, providing information on how to devise better strategies, policies, and choices among health interventions; how to put those decisions into practice; and how to allocate scarce resources to implement them.” Available online at: <http://www.dcp2.org/pubs/PIH>.

### *Global Burden of Disease and Risk Factors*

This book, published in 2006, “summarizes the concepts and estimates of the burden of disease and the attribution of this burden to several major risk factors.” Available online at: <http://www.dcp2.org/pubs/GBD>.

### *The Global Burden of Disease: 2004 Update*

This report, published by WHO in 2008, is a comprehensive assessment of the health of the world’s population. It provides detailed global and regional estimates of premature mortality, disability and loss of health for 135 causes by age and sex. Available online at: [http://www.who.int/healthinfo/global\\_burden\\_disease/2004\\_report\\_update/en/index.html](http://www.who.int/healthinfo/global_burden_disease/2004_report_update/en/index.html).

### *Using Cost-Effectiveness Analysis for Setting Health Priorities*

This Factsheet was published in 2008 by the Disease Control Priorities Project: “Governments around the world face budget constraints that compel them to make tough decisions about how best to invest funds for public health. They need a way to evaluate which investments will address the most pressing health problems and bring the greatest health gains. Cost-effectiveness analysis is an essential evaluation tool that allows policymakers and health planners to compare the health gains that various interventions can achieve with a given level of inputs.” Available online at: <http://www.dcp2.org/file/150/DCPP-CostEffectiveness.pdf>.

### *What Makes Cities Healthy?*

This World Bank Policy Research Working Paper, published in 2007, answers the question posed in its title as follows:

“The benefits of good health to individuals and to society are strongly positive and improving the health of the poor is a key Millennium Development Goal. If the objective is better health outcomes at the least cost and a reduction in urban health inequity, this research suggests that the four most potent policy interventions are: water and sanitation systems; urban land use and transport planning; effective primary care and health programs aimed at influencing diets and lifestyles; and education. The payoff from these four in terms of health outcomes dwarfs the returns from new drugs and hospital-based curative medicine.” Available online at: <http://go.worldbank.org/ZI8RS10F70>.

### Chapter 2: Key Messages

1. **Inadequate water supplies and inadequate sanitation, together with poor personal and domestic hygiene, are the cause of water- and excreta-related diseases.**
2. **Water- and excreta-related diseases have a very high adverse health impact in low- and middle-income countries.**
3. **The environmental classification of water- and excreta-related diseases groups these diseases into categories defined by a common environmental transmission route, so enabling engineers to design effective sanitation and water-supply interventions.**
4. **Prolonged exposure to some water- and excreta-related pathogens can induce cancer.**

Turning a challenge into a learning curve.  
Just another day at the office for a high performer.

#### Accenture Boot Camp – your toughest test yet

Choose Accenture for a career where the variety of opportunities and challenges allows you to make a difference every day. A place where you can develop your potential and grow professionally, working alongside talented colleagues. The only place where you can learn from our unrivalled experience, while helping our global clients achieve high performance. If this is your idea of a typical working day, then Accenture is the place to be.

It all starts at Boot Camp. It's 48 hours that will stimulate your mind and enhance your career prospects. You'll spend time with other students, top Accenture Consultants and special guests. An inspirational two days

packed with intellectual challenges and activities designed to let you discover what it really means to be a high performer in business. We can't tell you everything about Boot Camp, but expect a fast-paced, exhilarating

and intense learning experience. It could be your toughest test yet, which is exactly what will make it your biggest opportunity.

Find out more and apply online.

Visit [accenture.com/bootcamp](http://accenture.com/bootcamp)

• Consulting • Technology • Outsourcing



Please click the advert

# 3 Sanitation Systems

If people do not have a good water supply or access to a good sanitation facility, their health will suffer – in particular, as noted in Section 1.2, they will have one or more of the water- and excreta-related diseases detailed in Table 2.1, most commonly diarrhoeal diseases and one or more of the geohelminthiases. This chapter introduces some of the better low-cost sanitation systems that can be used in rural and urban areas. The effective management of human excreta for health requires that it is collected and stored safely, completely separated from human contact. Where space is insufficient excreta and related wastes (water and anal cleansing material) may need to be transported elsewhere for treatment. In some cases specialised treatment is needed particularly if excreta are to be re-used (for the production of energy or as agricultural fertilizer) or if their disposal presents an unacceptable risk to downstream water supplies. In rural areas treatment ‘at the point of production’ is usually possible. In dense urban settlements there is rarely sufficient space for this type of ‘on-site’ treatment and transport may be needed. In this book we are limiting our discussion to the design and delivery of systems for safe collection, onsite treatment where there is sufficient space and low-cost transport options for dense urban areas. Readers are referred to other sources for more information on appropriate treatment options for re-use and disposal of large volumes of sewage.

## 3.1 Rural Areas

### 3.1.1 Ending open defecation

In 2008 there were some 1,100 million ‘open defecators’ (i.e., people with no access to any sanitation facility whatsoever and so forced to defecate in the open) in the world and most of them lived in rural areas – 29% of the global rural population were ‘ODers’ in 2008 vs. only 5% of the global urban population.<sup>[1]</sup>

#### *Community-led Total Sanitation*

The CLTS movement was pioneered in Bangladesh in 2000 by Dr Kamal Kar, together with VERC (Village Education Resource Centre, a local NGO) and WaterAid Bangladesh, to end open defecation (OD) in rural areas. It involves the whole community and helps it to become ‘open-defecation free’ (ODF). CLTS has now spread to other countries in Asia (in India it is the government-run ‘Total Sanitation Campaign’) and to several countries in Africa.

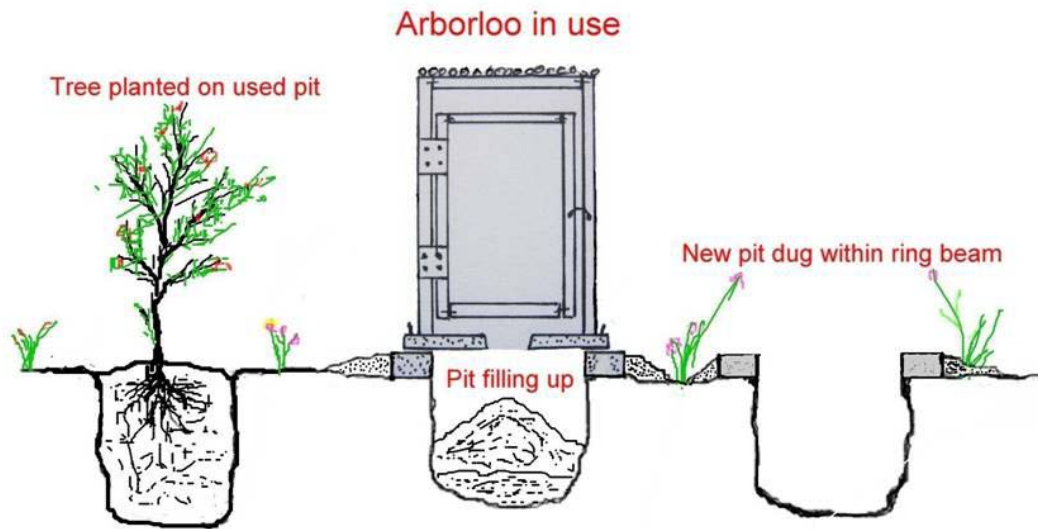
Kar describes it as follows:<sup>[2]</sup>

“CLTS focuses on igniting a change in sanitation behaviour rather than constructing toilets. It does this through a process of social awakening that is stimulated by facilitators from within or outside the community. It concentrates on the whole community rather than on individual behaviours. Collective benefit from stopping open defecation can encourage a more cooperative approach. People decide together how they will create a clean and hygienic environment that benefits everyone. It is fundamental that CLTS involves no individual household hardware subsidy and does not prescribe latrine models. Social solidarity, help and cooperation among the households in the community are a common and vital element in CLTS. Other important characteristics are the spontaneous emergence of Natural Leaders as a community proceeds towards ODF status; local innovations of low cost toilet models using locally available materials, and community-innovated systems of reward, penalty, spread and scaling-up. CLTS encourages the community to take responsibility and to take its own action. In its fullest sense, total sanitation includes a range of behaviours such as: stopping all open defecation; ensuring that everyone uses a hygienic toilet; washing hands with soap before preparing food and eating, after using the toilet, and after contact with babies’ faeces, or birds and animals; handling food and water in a hygienic manner; and safe disposal of animal and domestic waste to create a clean and safe environment. CLTS concentrates on ending OD as a first significant step and entry point to changing behaviour. It starts by enabling people to do their own sanitation profile through appraisal, observation and analysis of their practices of OD and the effects these have. This kindles feelings of shame and disgust, and often a desire to stop OD and clean up their neighbourhood.”

A word of caution is in order: in Pakistan it was found that “CLTS had the potential to motivate communities to achieve ODF status. However, it did not create demand for ‘improved sanitation’ [Table 1.1], which implies use of sanitation facilities that ensure hygienic separation of human excreta from human contact. The communities surveyed were found using unimproved and unhygienic latrines without taking any substantial effort to upgrade or replace damaged latrines due to limited knowledge of different latrine options available at the household level”.<sup>[3]</sup> Clearly CLTS-beneficiary communities need at least some sanitation and hygiene knowledge so that, when they move from open defecation to fixed-place defecation, the fixed place they use is at least an improved sanitation facility – CLTS programmes need to be sustainable.<sup>[4]</sup>

### 3.1.2 Arborloos

In dispersed rural areas often the most suitable sanitation system is the Arborloo (Figure 3.1).<sup>[5]</sup> This is a shallow pit latrine (typically 0.8 m in diameter and 1 m deep) which is used for 6–12 months. After each time the latrine is used soil, ash or leaves are added to the pit (after one use add one of these, after the next use one of the other two, and after the third use the remaining one, and so on – this ensures good humus production in the pit). When the pit is full to within around 20 cm of the ground surface the latrine superstructure is placed over a new pit, and the full pit covered with soil and a fruit or medicinal tree planted in it. Eventually the household has an orchard of high-value trees which generates both high-quality fruit and an income from the sale of excess fruit and/or medicinal products – “excreta in, money out”. In many rural households the men are away working in nearby towns or mines and the women generally like the Arborloo as they can dig the shallow pits themselves quite easily; moreover there is the advantage that, while the nutrients in the excreta are used to fertilize the trees, there is no handling of either faeces or urine (which many people would find repugnant).



# The Wake

the only emission we want to leave behind

Please click the advert

Low-speed Engines Medium-speed Engines Turbochargers Propellers Propulsion Packages PrimeServ

The design of eco-friendly marine power and propulsion solutions is crucial for MAN Diesel & Turbo. Power competencies are offered with the world's largest engine programme – having outputs spanning from 450 to 87,220 kW per engine. Get up front! Find out more at [www.mandieselturbo.com](http://www.mandieselturbo.com)

Engineering the Future – since 1758.

**MAN Diesel & Turbo**



Download free ebooks at [bookboon.com](http://bookboon.com)



**Figure 3.1:** The Arborloo – top: schematic diagram; bottom left: a simple Arborloo superstructure; and bottom right: a papaya tree planted in a full Arborloo pit.

### 3.1.3 Single-pit ventilated improved pit (VIP) latrines

VIP latrines have their superstructure slightly off-set from the pit to permit the installation of a vertical vent pipe which is fitted with a fly screen at its top (Figure 3.2).<sup>[6]</sup> The vent pipe has two functions: odour control and fly control (in contrast traditional – i.e., unventilated – pit latrines generally have serious odour and fly problems). The wind blowing across the top of the vent pipe sucks air out of the vent pipe, so creating a flow of air from outside the superstructure, down through the squat hole (or pedestal seat unit), and up and out of the vent pipe, taking with it all the malodorous gases from the decomposing faeces in the pit, so leaving the superstructure completely odour-free. Gravid female flies are attracted to the top of the vent pipe by the faecal odours coming out of it, but the fly screen blocks their entry, so they cannot enter the pit to lay their eggs. However, a few flies will enter the pit via the squat hole and lay their eggs in the pit; eventually these eggs become newly emergent adult flies, which always fly in the direction of the strongest light they can see. Provided the superstructure is kept reasonably dark, the strongest source of light they are able to see is the shaft of light coming down the vent pipe and so the newly emergent adult flies fly up the vent pipe, but the fly screen blocks their exit; due to a lack of food they quickly die and fall down into the pit.

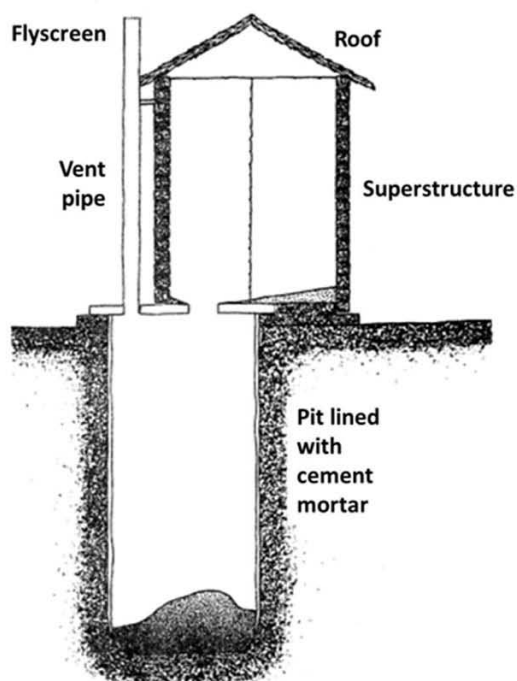
In all other respects VIP latrines function like any other pit latrine: the faeces slowly decompose in the pit and the urine and any water used to clean the squat slab or pedestal seat infiltrate into the surrounding soil. Typically the pit is 1–1.5 m in diameter, with a depth of ~3 m, and the vent pipe diameter is 100–150 mm (or ~225 mm square if the vent pipe is made of locally burnt bricks). The cover slab is raised 300 mm above ground level if the groundwater table is within 300 mm of ground level (either permanently or seasonally).

Single-pit VIP latrines are normally designed for an effective life of 10 years (the necessary design calculations are detailed in Annex A). After 10 years, when the pit is full to within ~30 cm of ground level, a new pit is dug and the coverslab, vent pipe and as much of the superstructure as possible are put in place over the new pit, which is used for the next 10 years. After the second 10 years the pit used during the first 10 years can be safely excavated and used again for the third 10 years.

### 3.1.4 Single-pit pour-flush (PF) toilets

Single-pit PF toilets (Figure 3.2) are used in rural areas, where there is space for a second pit to be constructed when the first is full [they can also be used in small towns and large villages (section 3.2) if there is sufficient space for them and they can be emptied mechanically (section 3.2.4)].<sup>[7,8]</sup> Squat-pans or pedestal-seat units with an integral water seal are used, depending on the users' preference; the water seal prevents insects and odours from the leach pit entering the superstructure. The excreta (faeces and urine) are manually flushed with 2–3 litres of water into an adjacent leach pit. The leach pit is always lined to prevent soil erosion by the flush water.

Single-pit PF toilets are, like single-pit VIP latrines, normally designed for an effective life of 10 years (the necessary design calculations are detailed in Annex A). After 10 years, when the leach pit is full to within ~30 cm of ground level, a new leach pit is dug and the squat-pan or pedestal seat unit and as much of the superstructure as possible are put in place over the new pit, which is used for the next 10 years. After the second 10 years the leach pit used during the first 10 years can be safely excavated and used again for the third 10 years.





**Figure 3.2:** Single-pit VIP latrine – top left: schematic diagram [in stable soils pit lining with cement mortar is sufficient, but in unstable (e.g., sandy) soils the pit must be lined more substantially (e.g., with bricks or concrete blocks; the vertical joints are left unmortared to allow the passage of liquids)]; top right: a ‘homemade’ single-pit VIP latrine in rural Zimbabwe; bottom left: glass-fibre-reinforced plastic flyscreen being mortared on to the top of a brick vent pipe; bottom right: reinforced concrete cover slab with a ‘keyhole’ for excreta, a circular hole the vent pipe, and two footrests to aid ‘depositional accuracy’.

Please click the advert

# Brain power



By 2020, wind could provide one-tenth of our planet’s electricity needs. Already today, SKF’s innovative know-how is crucial to running a large proportion of the world’s wind turbines.

Up to 25 % of the generating costs relate to maintenance. These can be reduced dramatically thanks to our systems for on-line condition monitoring and automatic lubrication. We help make it more economical to create cleaner, cheaper energy out of thin air.

By sharing our experience, expertise, and creativity, industries can boost performance beyond expectations. Therefore we need the best employees who can meet this challenge!

The Power of Knowledge Engineering

Plug into The Power of Knowledge Engineering.  
Visit us at [www.skf.com/knowledge](http://www.skf.com/knowledge)





### 3.1.5 Greywater

'Greywater' (also called 'sullage') is all the non-toilet/latrine wastewater produced by a household, so it includes wastewater from sinks, including kitchen sinks, showers and baths. Of course, in rural areas of developing countries households needing latrines are unlikely to have sinks, showers or baths, but they do produce some greywater from food preparation and clothes washing – usually around 10–20 litres per person per day. This relatively small quantity of greywater should be disposed of hygienically in, for example, a small greywater leach pit (typically 0.8–1 m in diameter and 1–1.5 m deep, filled with stones or brickbats); or it could be used to water a vegetable plot adjacent to the house.<sup>[9]</sup>

### 3.1.6 Groundwater pollution

There is the danger that viral and bacterial pathogens from VIP latrine pits and PF toilet leach pits can contaminate the groundwater (helminth eggs and protozoan (oo)cysts are too big to travel through soil). They do cause groundwater contamination in some circumstances – for example, in fractured rock and coarse sands – but not in all circumstances. The unsaturated zone (the partially saturated soil layer between the pit base and the groundwater table) is very effective in reducing the travel of viruses and bacteria, especially if its depth is 2 m or more.<sup>[13]</sup> A distance of 10–15 m between the latrine and a shallow well is generally sufficient to minimize groundwater contamination. If it is actually very important to prevent groundwater pollution (and it may not be – it is better to have the groundwater contaminated than the ground around houses), then the latrine pit should be sealed at its base with lean concrete and a 0.5-m annulus of fine (< 1 mm) sand inserted between the pit lining and the surrounding soil<sup>[10]</sup> – sand is especially effective in preventing the travel of viruses.

## 3.2 Small towns and large villages

In small towns and large villages some or all of the systems described in Section 3.1 as suitable for use in rural areas may also be suitable, depending on the population density. In some cases the density of houses may be higher than typical in true rural areas. Villages in India, for example, can have populations of up to around 10,000 people and so are not really rural, at least from the perspective of sanitation and water supply – the word ‘rurban’ has been coined to describe such large rural communities as, although they may be officially classified as rural, their sanitation and water-supply needs are more urban than rural. This section describes additional sanitation options that are appropriate in small towns and large villages – which can be considered as low- to medium-density urban areas.

### 3.2.1 eThekwini Latrines

eThekwini latrines (named after the municipality in KwaZulu-Natal, South Africa, where they were developed) are urine-diverting alternating twin-vault ventilated improved vault latrines (or UD-VIVs, for short)<sup>[11]</sup>. They are wholly above ground and comprise two separately ventilated vaults which receive only faeces and anal cleansing materials; the urine, diverted in a specially designed toilet bowl or squat-plate, is discharged into a small adjacent soakaway – this is done to keep the vault contents from becoming too wet, so they can dehydrate easily (Figure 3.4). One vault is used for 12 months, when the other vault is put into service; after the second vault has been used for ~11 months the first vault is emptied by the householder (using a long-handled shovel; the vault contents are buried on site), so that the first vault can be put back into service at the beginning of the third year. This sequence of alternating vault usage continues indefinitely. The design calculations for the required vault volumes are detailed in Annex A. In some locations, usually in rural areas, where appropriate markets exist, treated excreta from e-Thekwini latrines can be used or even sold as a fertilizer (urine) or soil conditioner (faeces).

The principal advantage of eThekwini latrines over ventilated improved pit latrines (Section 3.1.2) is their much greater ease of emptying. For this reason alternating twin-pit VIP latrines<sup>[6]</sup> are not described here as eThekwini latrines are generally to be preferred.



Please click the advert

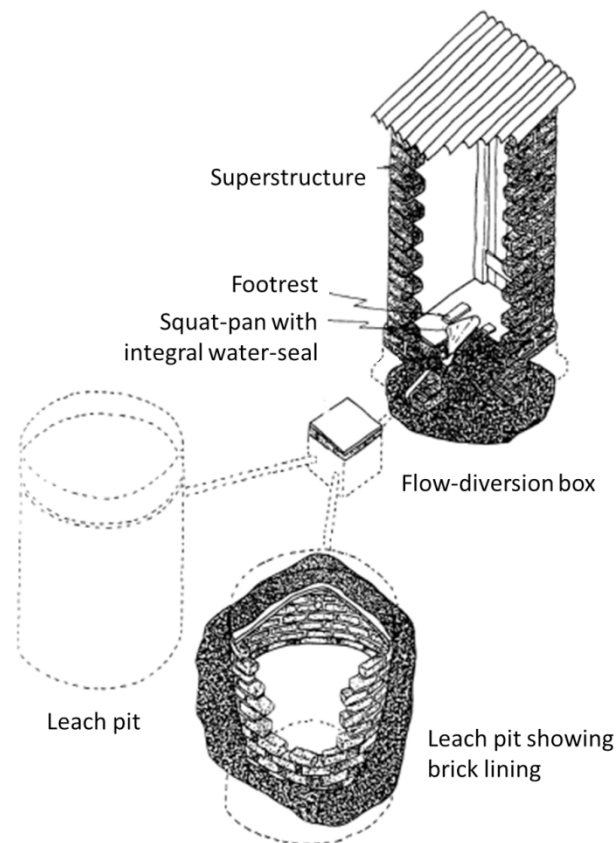
THIS **ebook** IS PRODUCED WITH **iText**®



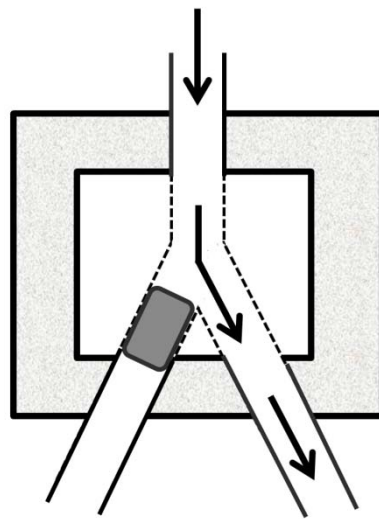
**Figure 3.4:** An eThekweni latrine – top left: front view showing the urine-diverting pedestal seat unit, urinal, and cover over the entrance to the vault not in use; top right: close-up of the urine-diverting pedestal seat unit; bottom left: rear view showing the two vent pipes (one for each vault) and the small urine pipe (in the centre) which leads to an adjacent soakaway; bottom right: close-up of one of the two vaults with the sliding door open showing the dehydrating vault contents.

### 3.2.2 Alternating twin-pit PF toilets

The two leach pits of alternating twin-pit PF toilets (Figure 3.5) are operated in the same alternating sequence as the twin vaults in eThekwini latrines. The excreta are flushed into the leach pit in use via a flow-diversion box, the outlet of which to the leach pit not in use is blocked off by a brick wrapped in hessian sacking (Figure 3.6). Each leach pit is normally used for two years (rather than one year, as with the eThekwini latrine vaults) to ensure that all pathogens, with the exception of a few *Ascaris* eggs, are dead, so permitting safe manual emptying (section 3.2.4).<sup>[7,8]</sup>



**Figure 3.5:** Alternating twin-pit pour-flush toilet.



**Figure 3.6:** Flow-diversion box for use with alternating twin-pit pour-flush toilets.

Please click the advert



Discover the truth at [www.deloitte.ca/careers](http://www.deloitte.ca/careers)

**Deloitte.**

© Deloitte & Touche LLP and affiliated entities.

Download free ebooks at [bookboon.com](http://bookboon.com)

### 3.2.3 Biogas toilets

Biogas toilets are another simple sanitation option for small towns and large villages.<sup>[12]</sup> Households have pour-flush toilet squat-pans (section 3.1.3) which discharge into a small anaerobic digester from which the biogas is collected and used for cooking and/or other domestic purposes (e.g., lighting). To increase biogas yields animal excreta are also often added to the digester. At intervals of 1–2 years the digester is desludged and the sludge so removed is either buried on site or used to fertilize a small vegetable plot. There are many such biogas toilets, especially in the Far East. In small towns in Vietnam most households have 3–4 pigs and both the pig and human excreta are discharged into a 1-m<sup>3</sup> anaerobic digester, and the resulting biogas is used for cooking (Figure 3.7).



Figure 3.7: Biogas toilets

### 3.2.4 Pit emptying

Manual emptying of alternating twin-pits/vaults is safe as all the excreted pathogens, except a few *Ascaris* eggs, are dead. However, manual emptying of the pits of single-pit latrines is not recommended as it is not only degrading work but also very hazardous as the workers are exposed to viable excreted pathogens, even when they are provided with protective clothing (which is the exception, not the rule).<sup>[13]</sup> Mechanical pit emptying should be employed instead, but even this is difficult, especially with 'dry' pits [i.e., pits with their base above the groundwater table – if the pit is a 'wet' pit (base above the groundwater table) then standard vacuum tankers of the type used to desludge septic tanks can be used]. Part of the difficulty is due to the pits frequently being used for garbage disposal (Figure 3.8). Large powerful vacuum tankers able to empty dry pits have been developed,<sup>[14]</sup> but they are very expensive and are often unable to get sufficiently near the pits to empty them. Smaller tankers are now preferred; UN-Habitat developed the 'vacutug' for example (Figure 3.9).<sup>[15]</sup> In very dense urban communities, it may be more appropriate to design much smaller pits (not more than 1m deep for example) and plan for frequent emptying. This would facilitate the development of economically viable small mechanised emptiers.



**Figure 3.8:** Material removed from latrine pits in southern Africa



**Figure 3.9:** The 'vacutug' developed by UN-Habitat.



### 3.2.5 Greywater

In small towns and large villages greywater can be disposed of in greywater leach pits (section 3.1.4) if there is space for them, used to water vegetable plots if there are any, or discharged together with stormwater in covered drains (as shown in Figure 3.7, top left).<sup>[9]</sup>

### 3.2.6 Groundwater pollution

Due to the higher population density and thus higher latrine density in small towns and large villages groundwater contamination is more likely than in rural areas. Thus all VIP latrine pits and PF toilet leach pits should be built with a sand annulus as described in section 3.1.6, unless the groundwater is not used as a supply of drinking water.

## 3.3 High-density urban areas

### 3.3.1 Urbanization

Almost all population growth in the world over the next 40 years or so is expected to be in urban areas in developing countries, where the population is expected to increase from 2,500 million in 2009 to 3,520 million by 2025 and to 5,190 million by 2050 (Figure 3.10). Many (if not most) of these new urban residents will live in high-density low-income areas, including slums, where water and sanitation needs will be especially acute. Because of the high population densities in these areas on-site sanitation systems are not normally feasible, and therefore off-site systems such as simplified sewerage, low-cost combined sewerage, and community-managed sanitation blocks are more suitable.

Please click the advert



**MSM**  
MAASTRICHT SCHOOL OF MANAGEMENT

Increase your impact with MSM Executive Education

For almost 60 years Maastricht School of Management has been enhancing the management capacity of professionals and organizations around the world through state-of-the-art management education.

Our broad range of Open Enrollment Executive Programs offers you a unique interactive, stimulating and multicultural learning experience.

**Be prepared for tomorrow's management challenges and apply today.**

For more information, visit [www.msm.nl](http://www.msm.nl) or contact us at +31 43 38 70 808 or via [admissions@msm.nl](mailto:admissions@msm.nl)

the globally networked management school

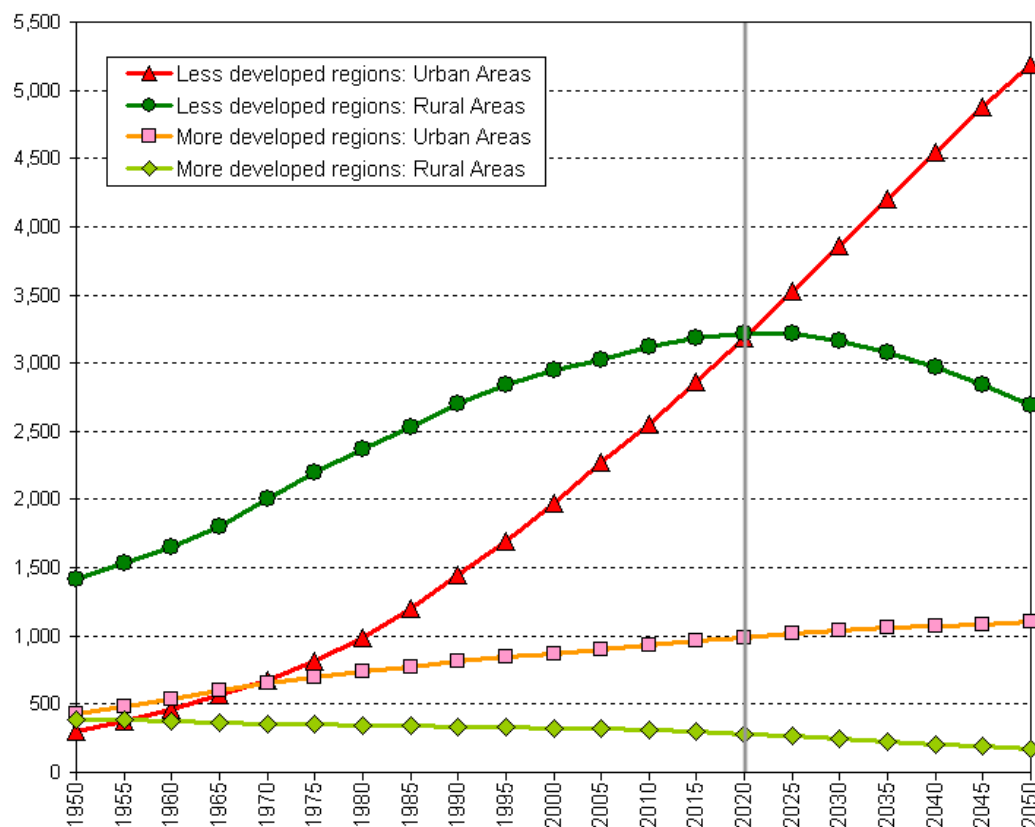
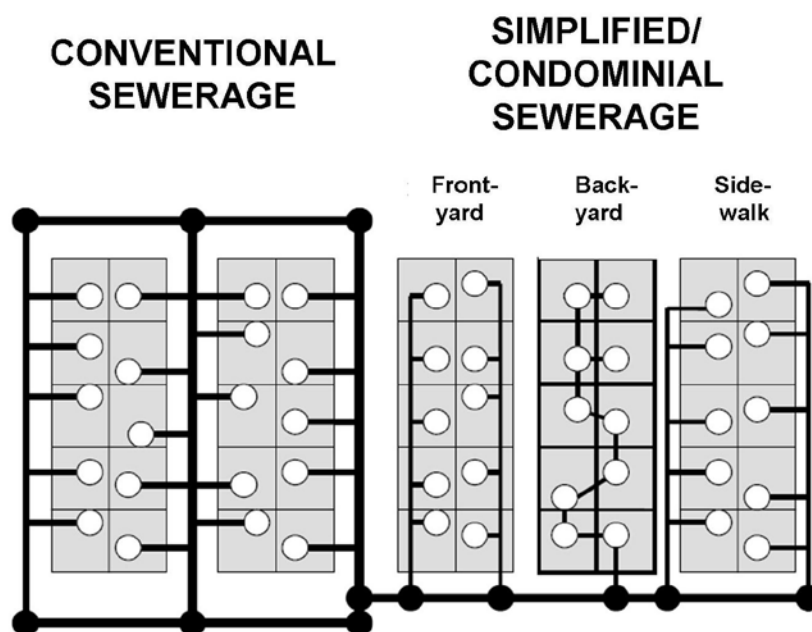


Figure 3.10: World urban and rural populations from 1950 projected to 2050.<sup>[16]</sup>

### 3.3.2 Simplified sewerage

Sewerage is a network of pipes ('sewers') that takes away all the domestic wastewater (toilet wastewater and greywater) from the houses where it is generated, to be treated and then disposed of elsewhere (often into a surface water or for use in aquaculture and/or agriculture). Conventional sewerage – the type of sewerage used in towns and cities in industrialized countries – uses very conservative values for minimum sewer diameters, gradients and depths which have accrued in design codes of practice over the last hundred years or so, with the result that per household construction costs are extremely high – certainly too high for low-income urban communities in developing countries. With simplified sewerage (also known as 'condominial' sewerage), which was developed in northeast Brazil in the early 1980s to serve high-density low-income urban areas, these very conservative design codes are relaxed in order to reduce the sewer diameter, minimum gradient and depth, and thus costs, while maintaining rigorous hydraulic design principles – in fact simplified sewerage is more rigorously designed than conventional sewerage (the hydraulic design of simplified sewerage is detailed in Annex B).<sup>[17-19]</sup>

Simplified sewer networks are very flexible, with the sewers laid inside a housing block, in the front garden, or under the pavement (sidewalk), rather than in the centre of the road as with conventional sewerage (Figure 3.11). This results in considerably less disruption to existing structures and major cost savings in construction. Simplified sewerage is appropriate both for existing unplanned periurban settlements and also for new housing estates with more regular layouts. As the population density increases, simplified sewerage becomes less expensive than on-site sanitation systems: in northeast Brazil this occurred at a population density of ~160 persons per ha (Figure 3.12), which is not a particularly high density; in South Africa the corresponding figure is ~200 persons per ha.



**Figure 3.11:** Typical layouts for conventional sewerage (left) and simplified sewerage (right). Conventional sewerage layouts are relatively inflexible and have long (and hence expensive) house connections. In contrast simplified sewerage is more flexible, with front-yard, back-yard and sidewalk (pavement) options. In poor areas the backyard option is generally the most appropriate choice as it is the cheapest.

The minimum sewer diameter used in simplified sewerage is 100 mm and, for a minimum tractive tension of 1 kN/m<sup>2</sup> (which ensures self-cleansing of the sewer), the minimum sewer gradient is 1 in 200 (i.e., 5‰) – see Annex B for details. A 100-mm diameter sewer laid at this gradient can serve ~200 households of five persons with a water consumption of 100 litres per person per day. A capital-cost comparison between conventional and simplified sewerage for the mining town of Paraupebas in the northern Brazilian state of Pará is given in Table 3.1, which shows that the cost of simplified sewerage is ~60% of that of conventional sewerage.<sup>[20]</sup> The unit (per household) costs of simplified sewerage fall as density rises. An analysis of the Paraupebas case indicated that simplified sewerage would be cheaper than onsite options at a density of around 160 persons per hectare. Recent analysis for Soweto, Johannesburg showed a similar pattern, with simplified sewerage being cheaper than e-Thekwini latrines at a density of around 125 persons per hectare.<sup>[21]</sup>

Please click the advert

**See the light!**  
**The sooner you realize we are right,  
 the sooner your life will get better!**

A bit over the top? Yes we know!  
 We are just that sure that we can make your  
 media activities more effective.



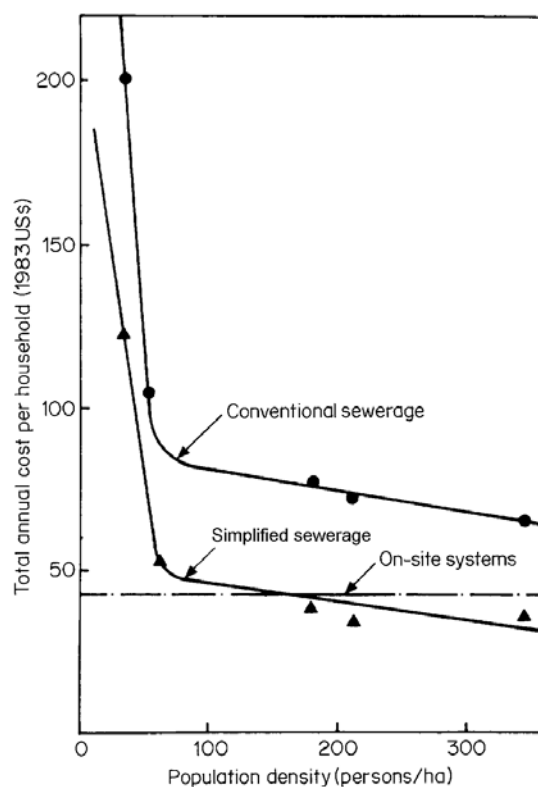
Get "Bookboon's Free Media Advice"  
 Email [kbm@bookboon.com](mailto:kbm@bookboon.com)









**Figure 3.12:** Total annual costs per household for conventional sewerage, simplified sewerage and on-site sanitation in the city of Natal, northeast Brazil in 1983. Simplified sewerage became cheaper than on-site systems at the relatively low population density of ~160 people per ha.<sup>[17]</sup>

**Table 3.1. Comparative costs (1997 USD) of conventional and simplified sewerage in the town of Parauapebas in the state of Pará in north Brazil.<sup>[20]</sup>**

Item	Conventional sewerage		Simplified sewerage	
	Total cost	Cost per connection	Total cost	Cost per connection
Excavation	263,000	39	186,000	28
Inspection chambers	181,000	27	85,000	13
Sewers	185,000	28	102,000	15
<b>Total</b>	<b>629,000</b>	<b>94</b>	<b>373,000</b>	<b>56</b>

2500–3000 vs. ZAR 6000–7000).<sup>[22]</sup> Actual costs to householders are very low: in the northeastern Brazilian state of Rio Grande do Norte the monthly cost per household in January 2008 was the equivalent of USD 3.50, which was only 1.7% of the local minimum wage – so simplified sewerage, done properly, is clearly affordable. Such are its advantages that the water and sewerage company for Brasília and the Federal District now only uses simplified sewerage in both rich and poor areas alike (and rich areas in Brasília are very rich indeed).

In upstream parts of the network, where the flow is intermittent, wastewater solids are gradually moved along the sewer each time a toilet is flushed. This transport process of ‘move → settle → move → settle’ is much more efficient in small diameter sewers than in unnecessarily large diameter sewers (remember the hydraulic dictum: “small flows flow better in small sewers”). PVC pipes are normally used as they are simply and reliably jointed, so there is minimal leakage or infiltration. Simple low-cost sewer junctions and cleanout and inspection units are used in place of expensive manholes (Figure 3.13).



**Figure 3.13:** Simple plastic junction box used in simplified sewerage instead of expensive manholes.

Operation and maintenance is straightforward. In Brazil the state water and sewerage companies (SWC) use several methods of O&M. For example, in Brasília residents report blockages to their local SWC office which then dispatches a van equipped with a water-jet unit; this is inserted in a junction box upstream of the blockage which is jetted to the next downstream junction box from where it is removed. In Recife in the northeastern state of Pernambuco the SWC employs small local engineering firms to do the O&M: typically a firm locates a technician engineer and 1–2 labourers in the area it is responsible for to whom residents report any blockages; the team then visits the blocked sewer and clears it manually.

A word of caution: for simplified sewerage to succeed well, the local water and sewerage agency must work closely with the community to ensure all community members understand how the system works, what their responsibilities are, and how much they have to pay; if this is not carefully done, the system is likely to fail.<sup>[23]</sup>

### Health benefits of simplified sewerage

Simplified sewerage was installed in Salvador, the capital of the state of Bahia in northeast Brazil, on a very large scale in the mid-1990s: serving over one million people, it represents “probably the largest single application of the condominal [simplified sewerage] model”.<sup>[20]</sup> During 1994–96 the system was almost entirely confined to the highly precarious urban slums, but from 1997 it began to be applied throughout the city, regardless of the type of topography, style of urbanization, or income of the beneficiary communities. A rigorous epidemiological study, done before and after the intervention, found that diarrhoeal-disease prevalence in children under the age of three fell by 22% on average, but in the poorest areas it fell by 43%.<sup>[24]</sup> A second city-wide study found that the prevalence of intestinal parasites in children under the age of five also fell: *Ascaris lumbricoides* from 24% to 12%, *Trichiura trichuria* from 18% to 5%, and *Giardia duodenalis* from 14% to 5%.<sup>[25]</sup>

### 3.3.3 Low-cost combined sewerage

‘Combined’ sewerage is the term used to describe a sewer system that conveys both municipal wastewater and stormwater. Low-cost combined sewerage was developed in low-income coastal areas in the state of Rio de Janeiro, Brazil, which were subject to regular flooding.<sup>[26]</sup> It was found to be less expensive than simplified sewerage and separate stormwater drainage. The sewer has to convey the dry-weather wastewater flow and the stormwater flow when it rains. In residential areas the stormwater flow which results from a 5-year storm (i.e., a storm that can be expected to occur, on average, once every 5 years) is used for design; in commercial/industrial areas the flow from a 10-year storm is used. The hydraulic design procedure is described in Annex C.

Please click the advert

**I WANT TO CHANGE DIRECTION,  
AND THE WORLD.**

**GOT-THE-ENERGY-TO-LEAD.COM**

We believe that energy suppliers should be renewable, too. We are therefore looking for enthusiastic new colleagues with plenty of ideas who want to join RWE in changing the world. Visit us online to find out what we are offering and how we are working together to ensure the energy of the future.

**RWE**  
The energy to lead

Download free ebooks at [bookboon.com](http://bookboon.com)

A similar system is used in India and Vietnam, but the household wastewater is first discharged into a septic tank and the tank effluent goes, together with the stormwater, into an open drain;<sup>[27,28]</sup> otherwise the design principles are as detailed in Annex C.

### 3.3.4 Community-managed sanitation blocks

In high-density low-income urban areas, especially slum areas, often the only viable sanitation system is community-managed sanitation blocks of the type promoted by SPARC (the Society for the Promotion of Area Resource Centres, an Indian NGO – [www.sparcindia.org](http://www.sparcindia.org)). These sanitation blocks are designed, built, owned and managed by the communities they serve: they are for the use of the community members, who pay for its upkeep – they are in no sense public facilities, although a community may allow casual use on payment of a per-use fee.<sup>[29]</sup>

These sanitation blocks are better designed and managed than conventional government-funded and contractor-built communal toilet blocks and they cost less. This model of community-designed, built and managed sanitation blocks is easily adaptable to other sociocultural settings: the key point is that each sanitation block is designed, built and managed by the community it serves. Generally help from a local NGO is required initially to catalyze community activity and to interact, on behalf of the community, with and obtain financial support from the local city or town council, which may not at the beginning take the views of poor slum communities seriously.

The SPARC approach has been successfully transferred to Kibera (Africa's largest slum) in Nairobi (Figure 3.14) by the Kenyan NGOs Maji na Ufanisi ('Water and Development') and the Umande Trust.<sup>[30-32]</sup>







**Figure 3.14:** Community-managed sanitation block in Gatwekera village, Kibera, Nairobi – top: the ground floor is the sanitation compartment with toilets, showers, clothes-washing facilities; and the top floor has a ‘community room’ used for meetings, weddings, parties, etc. and a small kitchen; bottom: underneath the ground floor is a large anaerobic digester which receives all the wastewater from the sanitation block; the biogas generated in the digester is used for cooking in the kitchen on the top floor.

### 3.4 Sociocultural factors

Many societies have traditional views and taboos about sanitation in general and faeces in particular – for example, (1) if you are a man, your mother-in-law cannot use the same latrine as you do (but your next-door neighbour’s mother-in-law can); (2) diarrhoea is the manifestation of an angry god; and (3) if your enemy has some of your faeces he has ‘control’ over you, so why would you excrete in a latrine where he can easily find some? A sensible sanitation engineer or planner would not dismiss such views (certainly not in front of the community), but instead work with the community to resolve any conflicts between such beliefs and the benefits of good sanitation. This is often also part of sanitation promotion and marketing (section 5.4).

#### 3.4.1 Wash or wipe? Sit or squat?

All peoples in the world can be divided into two categories – twice: people are either ‘washers’ or ‘wipers’ and either ‘sitters’ or ‘squatters’. Washers use water, and wipers use paper or other material, for anal cleansing. Sitters prefer to sit on a pedestal-seat unit whilst defecating and in case of women also whilst urinating, whereas squatters prefer to squat over a squat pan. Good physiological arguments can be made for squatting (better bowel evacuation), but really life is too short: if people are sitters give them pedestal-seat units, and if they are squatters give them squat pans (Figure 3.15).



**Figure 3.15:** The toilet in a house in Bradford, England, belonging to an Asian doctor who has some family members and friends who are sitters and some who are squatters, so he installed both a pedestal-seat unit and a squat-pan unit. Notice the flexible water pipe and tap between the two units and the toilet paper on top of the squat-pan cistern – provision for both washers and wipers.

Please click the advert

## Who is your target group? And how can we reach them?

At Bookboon, you can segment the exact right audience for your advertising campaign.

Our eBooks offer in-book advertising spot to reach the right candidate.



Contact us to hear more  
[kbm@bookboon.com](mailto:kbm@bookboon.com)



CREDIT SUISSE

DAIMLER



Microsoft

[bookboon.com](http://bookboon.com)

### 3.5 School sanitation

All schools should have separate sanitation facilities for girls and boys (Figure 3.16) – at present far too many schools do not have any sanitation facility.<sup>[33-35]</sup> If schools do not have separate facilities for girls and boys (or no facilities at all), then adolescent girls tend not to go to school when they are menstruating, so they lose out of ~25% of their education.<sup>[36,37]</sup>

In a study of women of reproductive age (15–44 years) in 175 developing countries, the number of years of schooling was found to have increased from an average of 2.2 in 1970 to 7.2 in 2009; more importantly during this 40-year period there were 8.2 million fewer deaths in children under 5 and around half this number could be attributed to the increased educational attainment in women of child-bearing age.<sup>[38]</sup> Educated women are healthier, wealthier (and thus more likely to have adequate sanitation – Figure 1.1), more likely to have children at a later age and fewer of them, less likely to die in childbirth, and more likely to send their children to school; furthermore their children live longer and healthier lives.<sup>[39]</sup>

Thus educating girls is extremely important for socio-economic development.<sup>[40,41]</sup> It is also integral to the MDGs: Goal 2 is to ‘Achieve Universal Primary Education’, with the specific target to ‘ensure that, by 2015, children everywhere, boys and girls alike, will be able to complete a full course of primary schooling’; and Goal 3 is to ‘Promote Gender Equality and Empower Women’, with the target to ‘eliminate gender disparity in primary and secondary education, preferably by 2005, and in all levels of education no later than 2015’.<sup>[42]</sup> Schools therefore have to be girl-friendly and, from a sanitation perspective, this means separate facilities for boys and girls.



**Figure 3.16:** Double-compartment VIP latrine at a rural school in Zimbabwe: one side for girls, the other for boys.

### 3.6 Ecological sanitation

We each excrete nearly enough nitrogen (N), phosphorus (P) and potassium (K) to fertilize all the basic carbohydrate (potato, maize, rice, soya, etc) we consume. As the price of artificial fertilisers rises there is renewed interest in the potential to capture nutrients (and energy) from human waste. This already occurs in some of the sanitation systems described above (from the simple Arborloo, to the reuse of treated wastewater collected in simplified sewer networks). The idea is often summarised by the phrase ‘closing the loop’ – encompassing the idea that human waste and food production are so closely linked that nutrients should be retained as ‘close to the point of production’ as possible.<sup>[43]</sup>

Some commentators also note that, since the bulk of the nutrient content is in the urine fraction of human excreta, we should keep the various waste streams [yellow water (urine), brown water (faeces + any flush water), and grey water (non-toilet wastewater)] separate to facilitate this and in particular to conserve phosphorus which is in short supply globally. There is nothing inherently wrong with this approach, which is very widely advocated,<sup>[e.g., 44]</sup> and commonly associated with the term ‘EcoSan’. However EcoSan toilets, which require diversion of urine at the point of production, remain an expensive option in many cases. They are usually too expensive for the rural or urban poor – who are not responsible for the global P crisis and who should not, in fairness, be required to have an expensive sanitation solution to partly solve it.<sup>[45]</sup> Having said that, eThekwini latrines (section 3.2.1) can be simply modified to act as EcoSan toilets. The key factor is to understand whether there is an opportunity to reuse the product; if users want to be able to reuse the waste (directly or through resale) and are willing to use the toilets appropriately, ecological toilets can work well.

In high-density urban areas where there is not the space for EcoSan toilets the “loop can be closed” by collecting all the wastewater streams together (i.e., as normal domestic wastewater) in a simplified sewerage network. Treatment can be provided in decentralized wastewater treatment plants – i.e., one treatment plant per catchment area which, if designed properly, can recover the energy in the wastewater (as biogas) as well as the NPK it contains so that it can be safely used for crop irrigation.<sup>[46]</sup>

Please click the advert



**THE BEST MASTER  
IN THE NETHERLANDS**

**Master of Science  
in Management\***



Source: ‘Keuzegids Higher Education Masters 2011’.  
\*In category business administration and accountancy & controlling.

 **NYENRODE**  
BUSINESS UNIVERSITEIT

**www.nyenrode.nl**

## References

1. *Progress on Sanitation and Drinking-water: 2010 Update*, World Health Organization & UNICEF, Geneva, 2010; available online at: [http://www.who.int/water\\_sanitation\\_health/publications/9789241563956/en/index.html](http://www.who.int/water_sanitation_health/publications/9789241563956/en/index.html).
2. K Kar & R Chambers, *Handbook on Community-Led Total Sanitation*, Plan UK, London & Institute of Development Studies, University of Sussex, Brighton, 2008; available online at: <http://www.communityledtotalsanitation.org/sites/communityledtotalsanitation.org/files/CLTshandbook.pdf>.
3. Moving beyond open defecation free sanitation in Pakistan, *Access Newsletter*, Water and Sanitation Program, Washington, DC, October 2009; available online at: [http://www.wsp.org/index.cfm?page=page\\_disp&pid=21096#southasia1](http://www.wsp.org/index.cfm?page=page_disp&pid=21096#southasia1).
4. S Movik & L Mehta, *The Dynamics and Sustainability of Community-led Total Sanitation (CLTS): Mapping Challenges and Pathways*, STEPS Centre, University of Sussex, Brighton, 2010; available online at: [http://www.steps-centre.org/PDFs/CLTS\\_web.pdf](http://www.steps-centre.org/PDFs/CLTS_web.pdf).
5. PR Morgan, *Toilets that Make Compost: Low-cost, Sanitary Toilets that Produce Valuable Compost for Crops in an African Context*, Stockholm Environment Institute, Stockholm, 2007; available online at: [http://www.ecosanres.org/toilets\\_that\\_make\\_compost.htm](http://www.ecosanres.org/toilets_that_make_compost.htm).
6. DD Mara, *The Design of Ventilated Improved Pit Latrines*, World Bank, Washington, DC, 1984; available online at: <http://go.worldbank.org/BG32HYWRM0>.
7. DD Mara, *The Design of Pour-flush Latrines*, World Bank, Washington, DC, 1984; available online at: <http://go.worldbank.org/Y4WMQGDO60>.
8. AK Roy, PK Chatterjee, KN Gupta, ST Khare, BB Rau & RS Singh, *Manual on the Design, Construction and Maintenance of Low-cost Pour-flush Waterseal Latrines*, World Bank, Washington, DC, 1984; available online at: <http://go.worldbank.org/AC6FWEEC40>.
9. A. Morel & S Diener, *Greywater Management in Low- and Middle-Income Countries*, Sandec/EAWAG, Dübendorf, 2006; available online at: [http://www.eawag.ch/organisation/abteilungen/sandec/schwerpunkte/ewm/projects/project\\_greywater](http://www.eawag.ch/organisation/abteilungen/sandec/schwerpunkte/ewm/projects/project_greywater).

10. AR Lawrence, DMJ Macdonald, AG Howard & others, *Guidelines for Assessing the Risk to Groundwater from On-Site Sanitation (ARGOSS)*, British Geological Survey, Nottingham, 2001; available online at: <http://www.bgs.ac.uk/research/groundwater/Argoss.html>.
11. *eThekwini UD-VIV Latrines*, webpage at: <http://www.personal.leeds.ac.uk/~cen6ddm/eThekwiniLatrines.html>.
12. HP Mang & Z Li, *Biogas Sanitation* (Technology Review No. 4), GTZ, Eschborn, 2010; available online at: <http://www.susana.org/lang-en/library?view=ccbkttypeitem&type=2&id=730>.
13. K Earles, *Bringing Pit Emptying out of the Darkness: A Comparison of Approaches in Durban, South Africa, and Kibera, Kenya*, BPD Water and Sanitation, London, 2005; available online at: [http://www.bpdws.org/bpd/web/d/doc\\_131.pdf?statsHandlerDone=1](http://www.bpdws.org/bpd/web/d/doc_131.pdf?statsHandlerDone=1).
14. A Bösch & R Schertenleib, Emptying on-site excreta disposal systems: Field tests with mechanized equipment in Gabarone (Botswana), *IRCWD News* 1985, (21/22), 1–10; available online at: [http://www.eawag.ch/organisation/abteilungen/sandec/publikationen/publications\\_sandec/general\\_sandec\\_publications/IRCWD\\_news\\_21\\_22](http://www.eawag.ch/organisation/abteilungen/sandec/publikationen/publications_sandec/general_sandec_publications/IRCWD_news_21_22).
15. *Sanitation – Vacutug*, UN-Habitat website at: <http://www.unhabitat.org/categories.asp?catid=548>.
16. *World Urbanization Prospects: The 2009 Revision – Highlights*, Department of Economic and Social Affairs, Population Division, United Nations, New York, 2010; available online at: [http://esa.un.org/unpd/wup/Documents/WUP2009\\_Highlights\\_Final.pdf](http://esa.un.org/unpd/wup/Documents/WUP2009_Highlights_Final.pdf).
17. GS Sinnatamby, *The Design of Shallow Sewer Systems*, United Nations Centre for Human Settlements, Nairobi, 1986; available online at: <http://www.unhabitat.org/pmss/listItemDetails.aspx?publicationID=1531>.

Please click the advert

## Do your employees receive the right training?

Bookboon offers an eLibrary with a wide range of Soft Skill training & Microsoft Office books to keep your staff up to date at all times.



Contact us to hear more  
[kbm@bookboon.com](mailto:kbm@bookboon.com)



CREDIT SUISSE

DAIMLER



Microsoft

[bookboon.com](http://bookboon.com)

Download free ebooks at [bookboon.com](http://bookboon.com)

18. DD Mara, PA Sleigh & K Tayler, *PC-based Simplified Sewer Design*, School of Civil Engineering, University of Leeds, Leeds, 2000; available online at: <http://www.personal.leeds.ac.uk/~cen6ddm/simpsewdesman.html>.
19. DD Mara & J Broome, Sewerage: a return to basics to benefit the poor, *Proceedings of the Institution of Civil Engineers: Municipal Engineer* 2008, **161**, 231–237; available online at: <http://www.personal.leeds.ac.uk/~cen6ddm/pdf%27s%202008+/muen.2008.161.4.pdf>.
20. JC Melo, *The Experience of Condominial Water and Sewerage Systems in Brazil: Case Studies from Brasília, Salvador and Parauapebas*, Water and Sanitation Program, Washington, DC, 2005; available online at: <http://www.wsp.org/UserFiles/file/BrasilFinal2.pdf>.
21. M Manga, *Lifecycle costs of low-cost Sanitation options for Chris Hani settlement, Soweto, South Africa* MSc(Eng) Dissertation, School of Civil Engineering, University of Leeds, Leeds, 2011.
22. *Sanitation for a Healthy Nation: Sanitation Technology Options*, Department of Water Affairs and Forestry, Government of South Africa, Pretoria, 2002; available at: [www.dwaf.gov.za/dir\\_ws/content/lids/PDF/Technical.pdf](http://www.dwaf.gov.za/dir_ws/content/lids/PDF/Technical.pdf).
23. G Watson, *Good Sewers Cheap? Agency-Customer Interactions in Low-Cost Urban Sanitation in Brazil*, The World Bank, Washington, DC, 1995; available online at: [http://www.wsp.org/UserFiles/file/global\\_goodsewerscheap.pdf](http://www.wsp.org/UserFiles/file/global_goodsewerscheap.pdf).
24. ML Barreto, B Genser, A Strina, MG Teixeira, AMO Assis and others, Effect of city-wide sanitation programme on reduction in rate of childhood diarrhoea in northeast Brazil: Assessment by two cohort studies, *The Lancet* 2007, **370**, 1622–1628; available online at: [http://www.thelancet.com/journals/lancet/article/PIIS0140-6736\(07\)61638-9/fulltext](http://www.thelancet.com/journals/lancet/article/PIIS0140-6736(07)61638-9/fulltext).
25. ML Barreto, B Genser, A Strina, MG Teixeira, AMO Assis and others, Impact of a city-wide sanitation programme in northeast Brazil on intestinal parasites infection in young children, *Environmental Health Perspectives* 2010, in press; available online at: <http://dx.doi.org/10.1289/ehp.1002058>.
26. ASP Guimarães & AP de Souza, *Projetos de Pequenos Sistemas Unitários de Esgotamento*, Caixa Econômica Federal, Brasília, 2004.
27. M Sundaravadivel, JA Doeleman & S Vigneswaran, Combined surface sewerage: a low-cost option for effective sanitation in semi-urban areas of India, *Environmental Engineering and Policy* 1999, **1** (3), 181–189; available online at: <http://www.springerlink.com/content/tr5m3by2d2dw0dw8/?p=48b8cd023cee4492a86cc5cbe5f14b44&pi=5>.
28. J. Beauséjour, & VA Nguyen, Decentralized sanitation implementation in Vietnam: a peri-urban case study. *Water Science and Technology* 2007, **56** (5), 133–139; available online at: <http://www.iwaponline.com/wst/05605/wst056050133.htm>.
29. S Burra, S Patel & T Kerr, Community-designed, built and managed toilet blocks in Indian cities, *Environment & Urbanization* 2003, **15** (2), 11–32; available online at: <http://eau.sagepub.com/cgi/reprint/15/2/11.pdf>.
30. Maji na Ufanisi, Kibera Integrated Water, Sanitation & Waste Management Project, webpage at: <http://www.majinaufanisi.org/projects/k-watsan.htm>.
31. Umande Trust: Communal biogas latrines in Nairobi, *Urban Health Updates* 2009; available online at: <http://urbanhealthupdates.wordpress.com/2009/04/27/umande-trust-communal-biogas-latrines-in-nairobi/#comment-1102>.
32. MAC Schouten & RW Mathenge, Communal sanitation alternatives for slums: a case study of Kibera, Kenya, *Physics and Chemistry of the Earth* 2010, in press; available online at: <http://dx.doi.org/10.1016/j.pce.2010.07.002>.
33. *Raising Clean Hands: Advancing Learning, Health and Participation through WASH in Schools*, UNICEF, New York, 2010; available online at: [http://www.unicef.org/media/files/raisingcleanhands\\_2010.pdf](http://www.unicef.org/media/files/raisingcleanhands_2010.pdf).
34. J Adams, J Bartram, Y Chartier & J Sims, *Water, Sanitation and Hygiene Standards for Schools in Low-cost Settings*, WHO/UNICEF, Geneva, 2009; available online at: [http://www.who.int/water\\_sanitation\\_health/publications/wsh\\_standards\\_school/en/index.html](http://www.who.int/water_sanitation_health/publications/wsh_standards_school/en/index.html).

35. *Towards Effective Programming for WASH in Schools: A manual on scaling up programmes for water, sanitation and hygiene in schools*, IRC International Water and Sanitation Centre, 2007; available online at: <http://www.irc.nl/page/37479>.
36. *Is menstrual hygiene and management an issue for adolescent school girls? A comparative study of four schools in Nepal*, WaterAid, Kathmandu, 2009; available online at: [http://www.wateraid.org/documents/plugin\\_documents/wa\\_nep\\_mhm\\_rep\\_march2009.pdf](http://www.wateraid.org/documents/plugin_documents/wa_nep_mhm_rep_march2009.pdf)
37. M Sommer, 'Menstruation is on her mind': Girl-centred, holistic thinking for school sanitation, *WASH in Schools Notes and News*, March 2008, pp. 4–6; available online at: <http://www.irc.nl/page/39859>.
38. E Gakidou, K Cowling, R Lozano & CLJ Murray, Increased educational attainment and its effect on child mortality in 175 countries between 1970 and 2009: a systematic analysis, *The Lancet* 2010, **376** (9745), 959–974; available online at: [http://www.thelancet.com/journals/lancet/article/PIIS0140-6736\(10\)61257-3/abstract](http://www.thelancet.com/journals/lancet/article/PIIS0140-6736(10)61257-3/abstract).
39. HA Patrinos, Returns to education: the gender perspective, in *Girls' Education in the 21st Century: Gender Equality, Empowerment, and Economic Growth* (ed. M Tembon & L Fort), pp. 53–66, World Bank, Washington, DC, 2008; available online at: [http://www.ungei.org/resources/files/DID\\_Girls\\_edu.pdf](http://www.ungei.org/resources/files/DID_Girls_edu.pdf).
40. 'Education for All' Global Monitoring Report, UNESCO website at: <http://www.unesco.org/en/efareport/>.
41. United Nations Girls' Education Initiative, website at: <http://www.ungei.org/index.php>.
42. UN Millennium Project: goals, targets and indicators, website at: <http://www.unmillenniumproject.org/goals/index.htm>.
43. S Esrey, I Andersson, A Hillers, R Sawyer *Closing the Loop; Ecological Sanitation for Food Security*, United Nations Development Program 2001; available online at: [http://www.ecosanres.org/pdf\\_files/closing-the-loop.pdf](http://www.ecosanres.org/pdf_files/closing-the-loop.pdf)
44. U Winblad & Mayling Simpson-Hébert, *Ecological Sanitation*, rev.ed., Stockholm Environment Institute, Stockholm, 2004; available online at: [http://www.ecosanres.org/pdf\\_files/Ecological\\_Sanitation\\_2004.pdf](http://www.ecosanres.org/pdf_files/Ecological_Sanitation_2004.pdf).



45. R Schuen, J Parkinson and A Knapp *Study for Financial and Economic Analysis of Ecological Sanitation in Sub-Saharan Africa* SuSana and Water and Sanitation Program, Washington DC, 2009; available on line at: [http://www.wsp.org/wsp/sites/wsp.org/files/publications/Ecosan\\_Report.pdf](http://www.wsp.org/wsp/sites/wsp.org/files/publications/Ecosan_Report.pdf)
46. *Guidelines for the Safe Use of Wastewater, Excreta and Greywater – Volume 2: Wastewater Use in Agriculture*, World Health Organization, Geneva, 2006; available online at: [http://www.who.int/water\\_sanitation\\_health/wastewater/gsuweg2/en/index.html](http://www.who.int/water_sanitation_health/wastewater/gsuweg2/en/index.html).

### Further Reading

John Kalbermatten, DeAnne Julius & Charles Gunnerson, *Appropriate Sanitation Alternatives: A Technical and Economic Appraisal*, Johns Hopkins University Press, Baltimore, MD, 1982; available online at: <http://go.worldbank.org/JKSLGN4OF0>.

John Kalbermatten, DeAnne Julius, Charles Gunnerson & Duncan Mara, *Appropriate Sanitation Alternatives: A Planning and Design Manual*, Johns Hopkins University Press, Baltimore, MD, 1982; available online at: <http://go.worldbank.org/7B6FR34OO0>.

Andy Peal, Barbara Evans & Carolien van der Voorden, *Hygiene and Sanitation Software: An Overview of Approaches*, Water Supply & Sanitation Collaborative Council, Geneva, 2010; available online at: [http://www.wsscc.org/fileadmin/files/pdf/publication/Public\\_Funding\\_for\\_Sanitation\\_the\\_many\\_faces\\_of\\_sanitation\\_subsidies.pdf](http://www.wsscc.org/fileadmin/files/pdf/publication/Public_Funding_for_Sanitation_the_many_faces_of_sanitation_subsidies.pdf).

Please click the advert

www.job.oticon.dk

**oticon**  
PEOPLE FIRST

Download free ebooks at [bookboon.com](http://bookboon.com)

Barbara Evans, Carolien van der Voorden & Andy Peal, *Public Funding for Sanitation: The Many Faces of Sanitation Subsidies*, Water Supply & Sanitation Collaborative Council, Geneva, 2010; available online at: [http://www.wsscc.org/fileadmin/files/pdf/publication/Hygiene\\_and\\_Sanitation\\_Software\\_WSSCC\\_2010.pdf](http://www.wsscc.org/fileadmin/files/pdf/publication/Hygiene_and_Sanitation_Software_WSSCC_2010.pdf).

Christoph Lüthi, Jennifer McConville & Elisabeth Kvarnström, Community-based approaches for addressing the urban sanitation challenges, *International Journal of Urban Sustainable Development* 2009, 1 (1–2),49–63; available online at: <http://dx.doi.org/10.1080/19463131003654764>.

Duncan Mara, *Water Supply and Sanitation Options for Small Urban Centres in Developing Countries*, UN-Habitat, Nairobi, 2006; available online at: [http://www.unhabitat.org/downloads/docs/6529\\_15410\\_Water%20Sector%20in%20Small%20Urban%20centres%20-%20WSS.pdf](http://www.unhabitat.org/downloads/docs/6529_15410_Water%20Sector%20in%20Small%20Urban%20centres%20-%20WSS.pdf).

L Sasse, *Biogas Plants*, Gesellschaft für Technische Zusammenarbeit (GTZ), Eschborn, 1988; available online at: <http://www.gate-international.org/documents/publications/webdocs/pdfs/g34bie.pdf>.

Kuma Alok, *Squatting with Dignity: Lessons from India*, SAGE Publications India Pvt Ltd, New Delhi, 2010; details at: <http://www.uk.sagepub.com/booksProdDesc.nav?prodId=Book234922&currTree=Subjects&level1=W00&>.

G Hutton, V Pfeiffer, S Blume, E von Münch & M Yaniv, *Cost and Economics* (SuSanA Factsheet), Sustainable Sanitation Alliance, Eschborn, 2009; available online at: <http://www.susana.org/lang-en/library/rm-susana-publications?view=ccbktypeitem&type=2&id=609>

Maggie Black & Ben Fawcett, *The Last Taboo: Opening the Door on the Global Sanitation Crisis*, Earthscan, London, 2008; details at: <http://www.earthscan.co.uk/?tabid=1494>.

Rose George, *The Big Necessity: Adventures in the World of Human Waste*, Portobello Books, London, 2008; details at: <http://www.portobellobooks.com/Books/The-Big-Necessity-b-format-paperback>.

### Chapter 3: Key Messages

1. **Open defecation needs to be eliminated through interventions like Community-led Total Sanitation (CLTS). In the move from open defecation to fixed-place defecation, the 'fixed place' must be at least an improved sanitation facility to ensure health gains.**
2. **In rural areas Arborloos, single-pit VIP latrines and single-pit pour-flush toilets are generally suitable.**
3. **In small towns and large villages eThekwini latrines, alternating twin-pit pour-flush toilets and biogas toilets can also be used.**
4. **In high-density low-income urban/periurban areas simplified sewerage is cheaper than on-site sanitation systems. In areas subject to regular flooding low-cost combined sewerage should be installed. In slums areas, if the cheapest household-level sanitation option is unaffordable, community-managed sanitation blocks are suitable.**
5. **School sanitation is very important, especially to keep teenage girls at school. Separate facilities for girls and boys should be provided at all schools.**

# 4 Water Supply Systems

Water is vitally important. People need water to survive. Water is needed for many different purposes: drinking, cooking, washing hands and cleaning the body, washing clothes, cleaning cooking utensils, cleaning the house, watering animals, irrigating the garden and commercial activities. In low-income communities, particularly in rural areas, different sources of water may be used for different purposes and at different times of the year as water resource availability varies with the seasons. All too often poverty and sheer necessity cause people to use supplies that are not fit to drink and give an unreliable or inadequate discharge. In this chapter we are concerned with how to improve these sources.

## 4.1 Rural Areas

### 4.1.1 Water Quantity

The quantity of water that people need and the amount that they will actually use will depend upon its availability and what it is used for. There are many factors that influence this including;

- whether water is easy to access and transport (the distance to the source and the time spent queuing will affect the volume used);
- the quality of the water (if the water is perceived to be of low quality then people will use less of it);
- local customs (some people prefer to bathe under running water or using a bucket and pour water over themselves – this uses a lot more water than those who use a bowl);
- the socio-economic status of the users (those with a high standard of living may take more baths and use flushing toilets that use high volumes of water); and
- whether or not people pay for the water (if there is a charge for using the water then this may reduce the amount that they use if they are charged by the volume used).

Water use data are frequently expressed in litres per person per day (lppd) although a large amount of water is shared between all the members of the household for cooking and cleaning. Typical measures of per capita consumption are useful however for estimating household and therefore community demand. Table 4.1 gives typical figures for water use by people at home, by livestock and by institutions. These figures are only estimates and, wherever possible when calculating the amount of water required by a community, it is best to obtain local information about water use and to study water consumption in neighbouring communities where the water supply has already been improved.

Table 4.1 – Typical values for daily water use <sup>[1,2,3]</sup>

People (litres per person per day (l/p/d))		Institutions (l/p/d)	
Minimum amount for survival	3 – 5	Health centre, out-patients	5
Drinking and cooking needs	8 - 10	Health centre, in-patients (without laundry)	40 – 60
Minimum supply needed	15 - 20	Cholera treatment centre	60
		Therapeutic feeding centre	15 – 30
		School	25
Livestock (litres/animal/day)			
Cattle	20 – 40		
Donkeys, horses	10 – 40		
Sheep, goats	1 - 5		

In conventional water supply schemes and those in urban areas it is not normally necessary to include water for livestock but in rural areas it is common for households to keep animals around the house. Therefore, an allowance must be made for animal watering, particularly during the dry season. Similarly, in rural areas (and where space allows in urban areas) irrigation of kitchen gardens close to the home is very common and can consume large volumes of water. Information on local farming practices are the best source for estimating how much to allow for in a design. The amount of water needed by institutions in the community should be added to the amount needed by the households, it should not be assumed that it can be deducted from the home use. Water use by local industries and commercial enterprises will also need to be considered and added to the demand estimate. In addition, allowance must be made for predicted changes in population; estimated changes in development (e.g. new houses, schools and other institutions); and for water lost both at water points and during supply – this is known as wasted or unaccounted for water (UFW). UFW can range up to 50% depending on the age of the scheme and how well it is maintained. It is reasonable to include an additional 20% for wastage and losses at the design stage.

#### 4.1.2 Levels of Rural Water Supply Service

In low-income countries water is often carried home from a water source in containers by hand or using animals – a tiring and lengthy but very necessary activity – and the amount of water collected is greatly affected by the distance from the water source to the home. It is often assumed that a good standard of personal and domestic hygiene can be achieved by supplying at least 40 litres per person per day (l/p/d). However, studies in Africa (see **Figure 4.2**) have shown that this amount of water will rarely be carried home from a water source because of the amount of time it takes to collect this volume of water for each member of a family. The amount of water collected remains fairly constant (at around 15 l/p/d) when the return journey takes between about three and 30 minutes <sup>[4]</sup>. Higher rates of consumption usually only start when water is supplied in the house or yard.

Please click the advert

Is your recruitment website still missing a piece?

Bookboon can optimize your current traffic. By offering our free eBooks in your look and feel, we build a qualitative database of potential candidates.



Contact us to hear more  
[kbm@bookboon.com](mailto:kbm@bookboon.com)

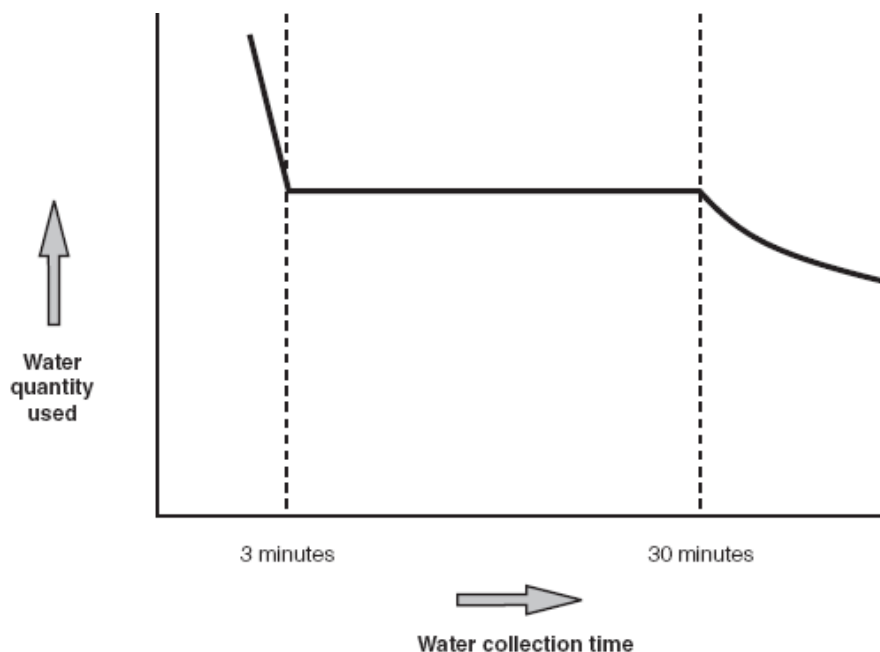









Figure 4.2: Water quantity used and time taken to collect water <sup>[4]</sup>



It is more likely that supplying 40 l/p/d can be achieved by a single water point or tap in a house or yard and that a communal water point (a well or a handpump) will provide less (because of the round-trip walking involved). **Table 4.2** shows that a communal water point will generally provide from 5 to 25 l/p/d (average consumption) depending on the distance from the house to the source. Providing more taps in the house will allow consumption to increase above 40l/p/d – assuming that the source can meet the demands of the community.<sup>[5]</sup> Thus the level of service provided (household taps versus communal supplies) has a profound effect on usage patterns in the home and therefore on health outcomes. The World Health Organisation recognizes this fact and has categorized water supplies into four service levels according to the associated level of health concern (see **Table 4.2**).

**Table 4.2: Summary of requirement for water service level to promote health <sup>[6]</sup>**

Service Level	Access Measure	Needs Met	Level of Health Concern
No access (quantity collected often below 5 lpcd)	More than 1000m or 30 minutes total collection time	Consumption – cannot be assured  Hygiene – not possible (unless practiced at source)	Very High

Basic Access (average quantity unlikely to exceed 20 lpcd)	Between 100 and 1000m or 5-30 minutes collection time	Consumption – should be assured  Hygiene – Handwashing and basic food hygiene possible; laundry, bathing difficult to assured unless carried out at source	High
Intermediate access (average quantity about 20 lpcd)	Water delivered through one tap on-plot (or within 100m or 5 minutes total collection time)	Consumption – assured  Hygiene – all basic personal and food hygiene assured; laundry and bathing should also be assured	Low
Optimal access (average quantity 100 lpcd and above)	Water supplied through multiple taps continuously	Consumption – all needs met  Hygiene – all needs should be met	Very low

The objective is thus to provide water as close to the home as possible to ensure adequate consumption. If a source has a low but constant yield water storage can be used to improve availability, which will in turn allow and encourage greater water use. A reservoir built at the source, and either connected to a piped water distribution system or provided with a tap (or taps), will allow users to draw sufficient water for their daily needs.

Alternatively, water can be stored at home. This is particularly useful when a source is unreliable as it maintains (and sometimes improves) availability. This might be during the dry season when a source has run dry or if access to a source becomes limited by seasonal weather conditions or physical constraints.

Local clay pots and jars, plastic jerry cans as well as larger ferrocement, plastic or fibre-glass tanks all make excellent storage containers (see **Figure 4.1**). A small opening or tap (to prevent people from dipping water out) and a tight fitting lid (to keep animals, insects and contaminated material out) are important characteristics. An additional advantage of storing water is that the water quality improves over time. If water is stored for one day over 50 per cent of the bacteria will die. Suspended solids, which can contain pathogens, will often settle out during storage. By using a tap positioned above the settled material or by pouring the clear water out carefully, the settled solids can be separated from the water.<sup>[7]</sup>





Please click the advert

## Turning a challenge into a learning curve. Just another day at the office for a high performer.

### Accenture Boot Camp – your toughest test yet

Choose Accenture for a career where the variety of opportunities and challenges allows you to make a difference every day. A place where you can develop your potential and grow professionally, working alongside talented colleagues. The only place where you can learn from our unrivalled experience, while helping our global clients achieve high performance. If this is your idea of a typical working day, then Accenture is the place to be.

It all starts at Boot Camp. It's 48 hours that will stimulate your mind and enhance your career prospects. You'll spend time with other students, top Accenture Consultants and special guests. An inspirational two days

packed with intellectual challenges and activities designed to let you discover what it really means to be a high performer in business. We can't tell you everything about Boot Camp, but expect a fast-paced, exhilarating

and intense learning experience. It could be your toughest test yet, which is exactly what will make it your biggest opportunity.

Find out more and apply online.

Visit [accenture.com/bootcamp](https://www.accenture.com/bootcamp)

• Consulting • Technology • Outsourcing

**accenture**  
High performance. Delivered.



**Figure 4.1** Typical storage containers include locally-manufactured clay and ceramic vessels and more modern plastic and ferro-cement alternatives.

As a rule, the less reliable the supply the greater the volume of storage required. For a household, where the source is considered to be reliable throughout the year, a storage capacity equivalent to the amount of water consumed in one or two days is considered adequate. For a less reliable source a larger volume should be stored.

#### 4.1.3 Water Quality

In the ideal world drinking water should be: <sup>[5]</sup>

- free from pathogenic (disease causing) organisms;
- contain no compounds that have an adverse effect (acute or in the long-term) on health;
- fairly clear (i.e., low turbidity, little colour);
- not taste salty or contain compounds that cause an offensive taste or smell; and
- not cause corrosion or encrustation of the water supply system, nor staining clothes washed in it.

Extensive research has enabled the production of tables that specify selected water quality parameters and their limits. These are based on evidence linking use of water of a particular quality with likely health outcomes. Until recently they formed the basis of international standards for water quality. These tables give the highest desirable and maximum permissible level for a range of chemicals and compounds. See the Guidelines for Drinking-water Quality published by WHO (2011).<sup>[7]</sup> However, more recently, it has been recognized that the blanket application of standards may be inappropriate, leading to over-designed and over-costly systems. In view of the urgent need to increase access to basic and intermediate supplies of water (see **Table 4.2**) the World Health Organisation now recognizes the need for a more flexible approach. It now recommends the development of Water Safety Plans. In the words of the latest edition of the guidelines:

“The most effective means of consistently ensuring the safety of a drinking-water supply is through the use of a comprehensive risk assessment and risk management approach that encompasses all steps in water supply from catchment to consumer. In these Guidelines, such approaches are termed water safety plans (WSPs). The WSP approach has been developed to organize and systematize a long history of management practices applied to drinking-water and to ensure the applicability of these practices to the management of drinking-water quality. It draws on many of the principles and concepts from other risk management approaches...”<sup>[7]</sup>

The use of water safety planning allows for a progressive approach to improving water quality. Ideally, a community will have a convenient, safe, reliable source of good quality water but in many situations this is not possible. Often people are forced to manage with a source that may be far away from their homes, difficult to access, unreliable and supplies either very little water or water of poor quality and frequently both. The new WHO approach allows for a pragmatic assessment of the main risks to health, and the selection of a best-fit solution.

**Chapter 2** describes the water- and excreta-related diseases (Water and excreta related diseases) and how poor personal hygiene favours disease transmission. It also highlights the large number of water-washed diseases that can be prevented both by washing hands and by washing body and clothes. In many cases an increase in water quantity may be more critical to health than improved quality.

Having said that, it is of course important to understand the context in which a new water supply scheme is being built or improved. A baseline study and sanitary survey will reveal important information about the frequency and severity of Water and excreta related diseases as well as the degree of access to- and use of- water, sanitation and hygiene facilities. For instance, where faecal-oral infections are common and sanitation, personal hygiene and food hygiene are considered adequate then the role of drinking water in the transmission of faecal-oral infections may well be significant.

Options for improving the quality of water at source include filtration and chlorination. Both have cost and management implications however. In addition, there is growing evidence that water which is pathogen-free at source may become contaminated during transportation and storage in the house<sup>[8]</sup>. A recent systematic review of good quality studies even suggested that treatment of water in the home (known as Point-of-Use or POU treatment) may be up to twice as effective at reducing diarrhea than improving water quality at the source<sup>[9]</sup>.

At the household level the main options for water treatment include chlorination (for which various proprietary systems are available), thermal or solar disinfection, filtration (also usually using proprietary systems) and combination flocculation and disinfection systems. Solar disinfection has been shown to be highly effective at removing pathogens and can be achieved using the simple 'SODIS' technology. In this system low-turbidity water is placed in clear plastic bottles in full sunshine for a period of 6-48 hours. Discarded PET drinking water bottles are ideal and they can usually be placed on the roof of the house to ensure good exposure to sunlight <sup>[10]</sup>.

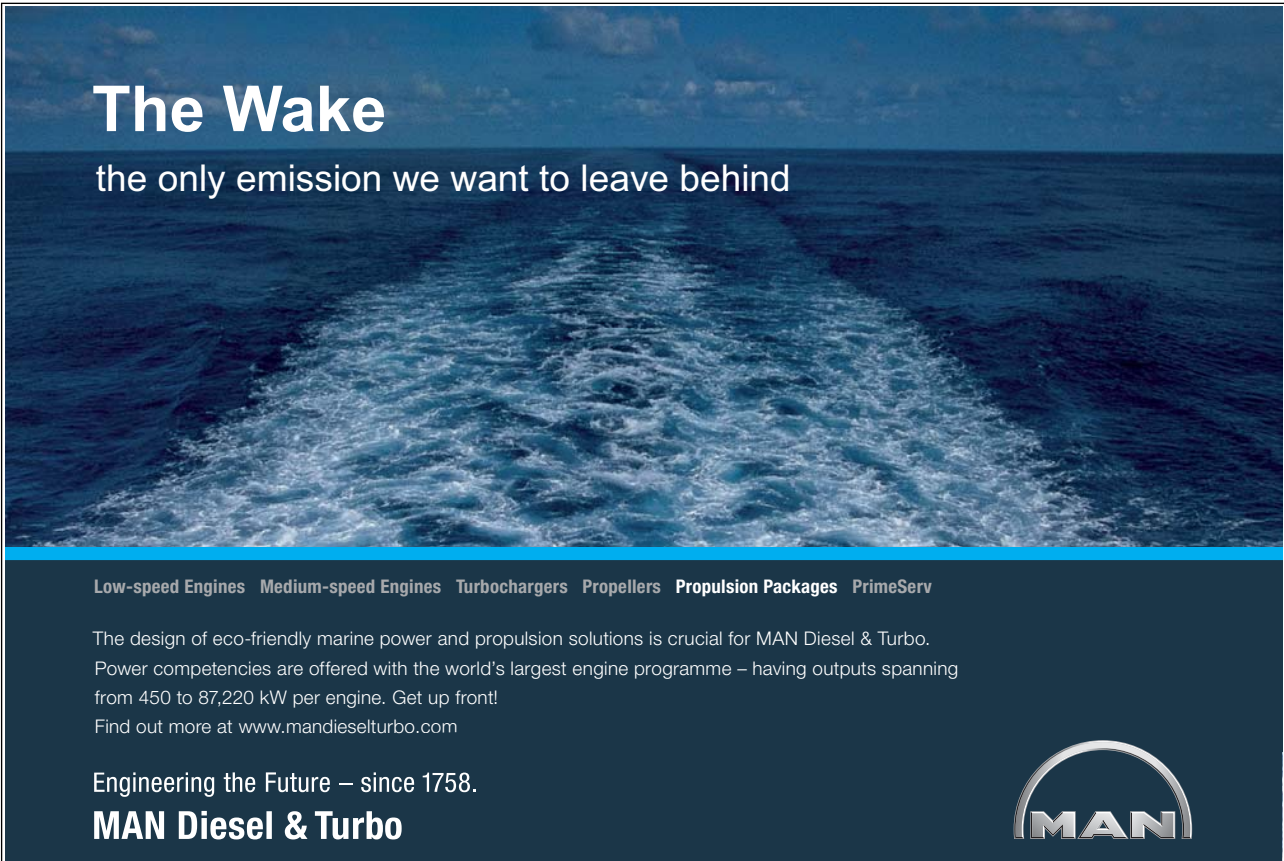
As well as pathogens, water may exhibit poor quality in terms of chemical contaminants. High levels of arsenic, fluoride and salts can all cause serious health problems and need to be addressed. These are usually more challenging and the most cost-effective treatments tend to be at source rather than household level treatment options.

#### 4.1.3 Water Sources

Three types of water sources are used in rural areas<sup>[11]</sup>:

- rainwater,
- groundwater and
- surface water.

Please click the advert




**The Wake**  
the only emission we want to leave behind

Low-speed Engines Medium-speed Engines Turbochargers Propellers Propulsion Packages PrimeServ

The design of eco-friendly marine power and propulsion solutions is crucial for MAN Diesel & Turbo. Power competencies are offered with the world's largest engine programme – having outputs spanning from 450 to 87,220 kW per engine. Get up front!  
Find out more at [www.mandieselturbo.com](http://www.mandieselturbo.com)

Engineering the Future – since 1758.  
**MAN Diesel & Turbo**



### Rainwater collection

Rainwater is a valuable source of water and, when properly collected and stored, it will usually be of good quality. It can be collected using a ground catchment area or from house roofs. The quality of the water collected will be affected by the presence of contaminants on the catchment area – the tiled roofs or the ground surface. Therefore, it is important that the catchment area and any gutters and channels which collect and convey the water, are kept as clean as possible. The first few minutes of rainfall are best discarded to avoid collecting unwanted material like dust, debris or bird droppings. The stored rainwater can be used to supplement other, possibly inadequate, domestic water sources and also for irrigation but since rainwater is seasonal it is not usually appropriate as the only source of water. The volume of storage is dependent upon making a best possible estimate of the amount of rainwater expected and the size of the catchment area. It is also helpful to know the number of ‘dry’ days when there will be no rainfall and what the daily water demand will be during this time (Figure 4.2).



**Figure 4.2:** Rainwater harvesting from rooftops in Chennai India <sup>(12)</sup> and Kenya <sup>(13)</sup> A variety of materials can be used to store the collected water. Plastic vessels are often available in the local market and are light to transport and generally fairly cheap. Where these are not available, in-situ construction using light-weight ferro-cement is a good alternative. Underground tanks may be preferred in some locations due to greater storage capacity and the fact that water supplies tend to remain cooler.

### Surface water

Surface water is often the easiest water source to access; a significant percentage of unimproved water sources are simply unprotected streams, ponds or lakes from which communities collect water. However, because of this they are easily polluted and very prone to faecal contamination. They are also affected by seasonal variations in turbidity ('muddiness') and flow.

Variations in turbidity hinder effective treatment processes while variations in flow make it difficult to locate and design appropriate abstraction systems (gravity intakes or pumps to lift the water mechanically). Surface water can be screened to remove larger solids (leaves, pieces of wood) and filtered to remove suspended solids and to reduce or eliminate bacteria and other pathogens, but these systems all need to be appropriately sized and designed. Usually water from lakes or rivers must be pumped up to the community. The alternative option is to raise the water level in a river through a dam or barrage. Often surface water schemes are only cost-effective if the intake structures are sized to produce large volumes of bulk water supplies to be shared between a number of communities. These multi-village schemes tend to be much more complex than other rural water supply systems and more sophisticated management arrangements are needed than for most other options.

Where surface water is the only option then care is needed to minimize pollution risks – usually by siting intake structures well upstream of human habitation and agriculture and by providing appropriate treatment.

### Groundwater

Except in areas suffering from specific chemical contamination issues (arsenic, fluoride etc) groundwater is usually of better quality than surface water; faecal contamination is nearly always a much smaller issue than for surface water sources. It is effectively surface water that has sunk into the ground where it can remain for a long time in a water bearing strata (an aquifer). Groundwater may be obtained from springs, hand-dug wells or boreholes (also known as tubewells):

#### *Protected springs*

As groundwater reaches the surface, the risk of pollution increases either from natural sources or through human and animal action. Spring sources, which are naturally clean and safe, therefore need to be properly designed, built and maintained to protect the water from contamination. The spring protection work should also improve accessibility of the water for users and, if possible, increase the water flow (in order to increase the water availability).

Simple protection measures include fencing off or erecting a wall around the spring, building a headwall and a drainage system to protect the spring from erosion and steps or a ramp so that users can access the source easily. Use of the spring will need to be managed and pit latrines and animal pens should not be sited 'upstream' of the spring location (**Figure 4.3**).



Figure 4.3. Example of Spring Protection from a WaterAID project in Uganda [15]

*Protected hand-dug wells*

Traditional unprotected wells or water holes are usually of poor design. As a result, they contain water polluted with faecal pathogens and are prone to running dry during the dry season. Similar to the spring protection measures mentioned above these problems can be eliminated by some simple improvements for instance by;

- Moving latrines and animal pens away from it (at least 25 m);
- Deepening the well so that it reaches the groundwater during the dry season;

Please click the advert

# Brain power



By 2020, wind could provide one-tenth of our planet's electricity needs. Already today, SKF's innovative know-how is crucial to running a large proportion of the world's wind turbines.

Up to 25 % of the generating costs relate to maintenance. These can be reduced dramatically thanks to our systems for on-line condition monitoring and automatic lubrication. We help make it more economical to create cleaner, cheaper energy out of thin air.

By sharing our experience, expertise, and creativity, industries can boost performance beyond expectations. Therefore we need the best employees who can meet this challenge!

The Power of Knowledge Engineering

Plug into The Power of Knowledge Engineering.  
Visit us at [www.skf.com/knowledge](http://www.skf.com/knowledge)



- Lining the well to stop it collapsing (the bottom is left unlined so that water can get in);
- Providing a parapet wall around the well-head and a cover so that people and animals cannot get in;
- Laying a hard-standing around the well-head which drains waste water away from where people stand; and
- Installing a lifting mechanism that prevents the vessel and rope from being contaminated (e.g., by being left on the ground). A windlass and bucket are suitable or a handpump.

Once these improvements are in place, and the facility is looked after and used appropriately by the community, the water supply will be safe and the water will generally be of average to good quality.

### *Boreholes*

A hand- or machine-drilled borehole will usually produce good quality water. Instead of a large diameter well a small diameter borehole is drilled and a handpump or motorized pump installed to withdraw water. Similar design considerations regarding pollution, contamination and use, which were made for springs and hand-dug wells, apply for boreholes as well; the hole must be sealed and lined and a plinth with adequate drainage should be provided at the well-head. Although boreholes will only work where a suitable aquifer is found they do have significant advantages compared to hand-dug wells, namely:

- Greater depths are usually possible than with hand-dug wells;
- Mechanised drilling rigs can usually deal with any type of rock stratum;
- They are quicker to dig than a hand-dug well;
- The small diameter hole when sealed properly completely prevents pollution; and
- They are fitted with either a narrow bucket or handpump which also prevents contamination by users.

However, they do have some disadvantages:

- The material cost is higher – the casing, screens, pipes and handpumps need to be of sufficient quality and may not be available locally.
- A higher level of technical support is required during construction than with hand-dug wells; and
- Maintenance of a handpump or narrow bucket pump is more complicated than a bucket and windlass system and replacement parts may again be expensive and difficult to source.

**Table 4.3** shows a comparison of the capital and running costs of the different rural water sources. The cost of rainwater catchment is comparatively low. The capital cost will increase with the volume of storage tank that is required while running costs are very minimal. In contrast both the capital and running costs are high for surface water sources, especially when relatively complex intake designs have to be built and both treatment and pumping to supply are required as well.



Where a community can build and run an improved hand-dug well by themselves this will be the lowest cost groundwater option. A protected spring is also cheap to establish and once installed the running costs will be minimal. If the villagers travel to the spring to collect water and hand-carry it back to their houses the capital cost will be low; if however, long lengths of supply pipes have to be laid to the community then the capital costs will rise (perhaps to a 'medium' level) and there will be additional running costs to repair breakages and leakage. The cost of drilling and lining a borehole and the need for maintenance of the pump means that both the capital and running costs of boreholes are regarded as being 'medium' level.

**Table 4.3: Comparison of costs for water supply to rural areas <sup>[17]</sup>**

Water Source	Capital Cost	Running Cost	Comments
Rainwater catchment	Low to medium.  Storage tanks needed.	Low	Dependent on climate. Water quality is poor.
Surface water (river/canal/ lake abstraction)	High  Design and construction of intake.	High.  Treatment and pumping needed.	Last resort.  Filtration essential. Maintenance required for filtration and pumping.
<b>Groundwater</b>			
Spring protection	Low  Medium if piped to community.	Low	Requires a reliable spring flow throughout the year
Hand dug wells	Low (use local labour).	Low	Abstraction can be by bucket and windlass or by handpump.
Boreholes (or tubewells)	Medium  Well drilling equipment needed.  Boreholes needs to be lined.	Medium.  Requires mechanical pumping.	Suits deep underground aquifer. Needs maintenance of mechanical pump.

## 4.2 Urban areas

As shown in **Figure 3.7**, the world is urbanizing rapidly and most population growth in the next few decades will be in urban areas in developing countries – this population is expected to increase from 2,500 million, its 2009 value, to 3,520 million by 2025 and to 5,190 million by 2050.<sup>[15]</sup>

In 2008 94% of the urban population in developing countries, which then numbered 2,400 million people, had 'improved' water supplies (Table 1.1) and 73% had household connections to piped supplies.<sup>[16]</sup> Thus most of those without a piped supply had an 'improved' supply but, as shown in **Figure 1.3**, this does not necessarily mean they had an 'adequate' supply. The majority of these people would have been poor or very poor, so it is very unlikely that many of them would have had an adequate water supply.

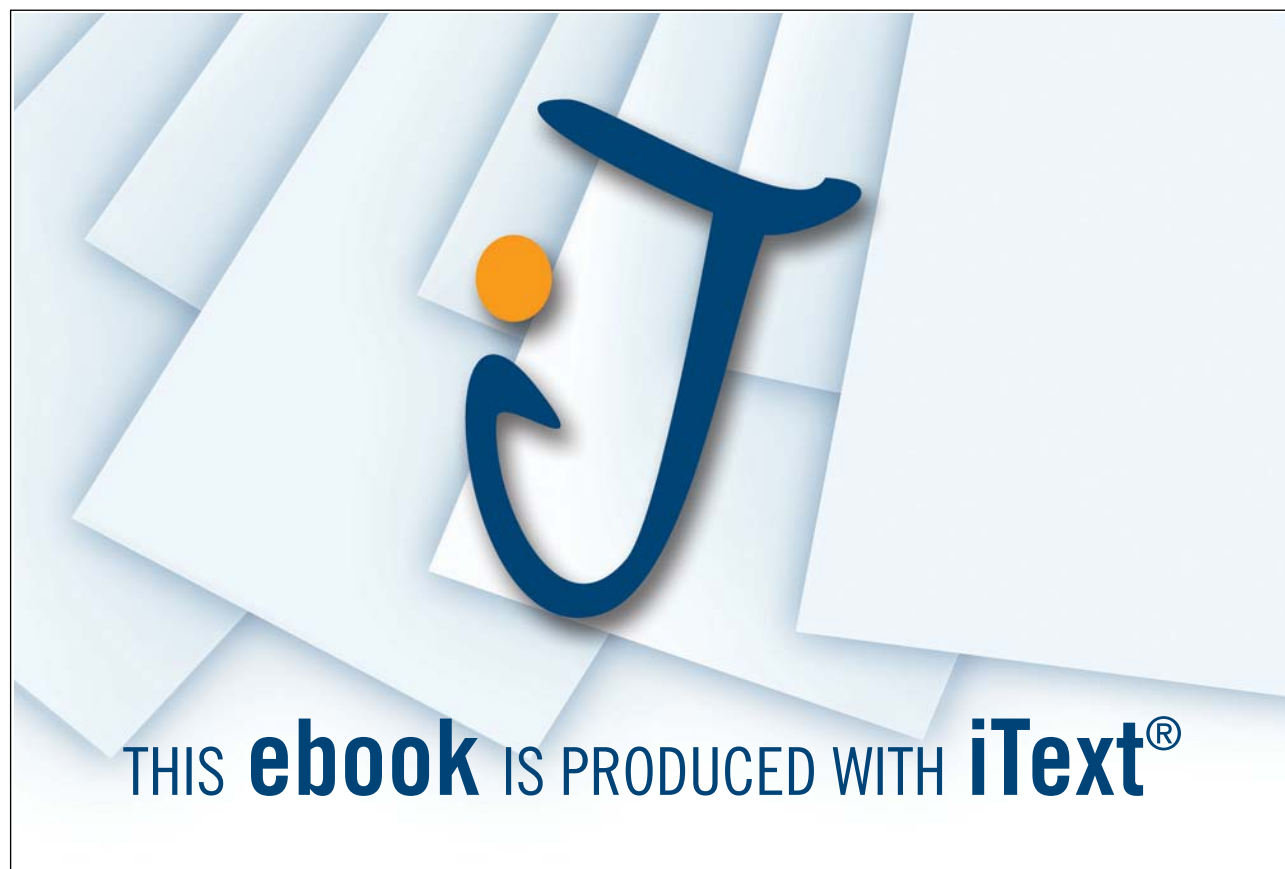
#### 4.2.1 Levels of urban water-supply service

There are four levels of water-supply service in urban areas:

0. Hand-carried non-piped supplies – people collect water in containers from unprotected and commonly polluted sources such as springs and streams/ivers,
1. Hand-carried piped supplies – people collect water in containers from public 'standpipes' (public taps) or they purchase water by the container-full from water kiosks, water vendors or water tankers;
2. Yard-tap piped supplies – one tap per household, and
3. Multiple-tap in-house piped supplies (this is generally only an option for the non-poor).

Clearly Level 0 represents a wholly inadequate supply. The problem with Level 1 supplies is that, if the water is piped water obtained from water kiosks and water vendors, then the water is very expensive – this is what Professor John Briscoe (now of Harvard University) had to say in a radio interview in 2003 when he was the senior water adviser at the World Bank:<sup>[17]</sup>

Please click the advert



“You can go to virtually any city in the developing world, and you’ll find a whole industry of people selling water out of trucks, water vendors who are selling water at 10 times the rate that you and I pay for water in Washington, DC, to people whose income is less than a dollar a day. Carrying water around on trucks and on people’s shoulders is a very, very inefficient way to provide the service. So you could go in and you could provide service to people, to poor people, at a fraction of what they’re now paying, and they’ll pay the full cost of that service.”

In fact poor people with a Level 1 piped supply pay many times more than the non-poor in the same city who have a Level 3 supply – for example, in Asian cities the poor often pay USD 20 per month for 6 m<sup>3</sup> of water, whereas the rich only pay USD 4 per month for 30 m<sup>3</sup> of water – so the poor are paying 25 times more per m<sup>3</sup> of water than the rich and for a much worse service.<sup>[18]</sup> Clearly this cannot be right.

Thus the biggest challenge in increasing access to adequate piped water supplies in low-income urban areas, including slums, is to get urban water agencies (which may be a public agency – part of the town/city council or a state/provincial water supply authority/company – or a private company operating the supply for a public agency) to realise that they can do this by extending urban piped water supplies into these poor areas by working with poor communities to do this in an affordable way (see section 4.2.2).

#### 4.2.2 The New Paradigm for urban water supplies

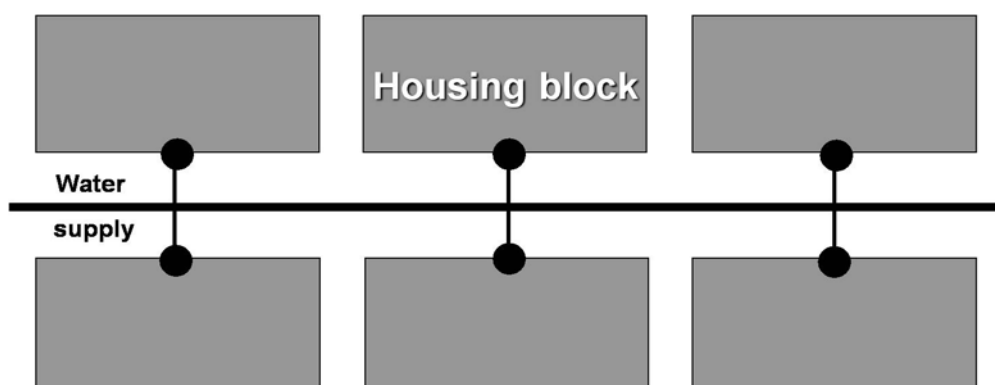
To meet universal water supply and sanitation coverage in low-income and often high-density urban areas sooner rather than later requires a totally new approach – a ‘New Paradigm’, which can be very simply stated as follows:<sup>[19]</sup>

**Supply water and sanitation to groups of households, not to individual households**

The reason for this is extremely simple: reduced costs. Table 4.3 shows the cost advantages of ‘condominial’ water supplies in the mining town of Parauapebas in the state of Pará in north Brazil.<sup>[23]</sup> The supply was for 250 litres per person per day from multiple-tap in-house connections with an initial connection rate of 90 percent. The conventional supply was for individual household connections and the condominial supply for one connection per condominium (i.e., per group of households or housing block – **Figure 4.4**). The cost per connection for the condominial supply was roughly one quarter of that for the conventional supply.

**Table 4.3: Costs in 1997 USD of conventional and condominial water supplies in Parauapebas, Pará, north Brazil**

Item	Conventional supply		Condominial supply	
	Total cost	Cost per connection	Total cost	Cost per connection
Excavation	454,000	88	101,000	19
Pipes	407,000	79	129,000	25
<b>Total</b>	<b>861,000</b>	<b>167</b>	<b>230,000</b>	<b>44</b>



**Figure 4.4:** Condominial water supply: there is only one connection (●) per housing block/cooperative leading to communal standpipes, individual yard taps or, for non-poor cooperatives, multiple-tap in-house supplies.

José Carlos Melo, who developed the condominial system in Brazil, describes Parauapebas as presenting “a rare example of applying the condominial model to the water sector and illustrates the potential operational advantages that condominial designs bring to water systems. Moreover, the city was able to mobilize large-scale community participation in the construction of the network. The result was the very rapid expansion of water coverage at a fraction of the cost of a conventional system.”<sup>[20]</sup>

The high level of water supply service adopted in Parauapebas is not, of course, applicable to poor urban communities in developing countries, but the condominial concept is. It can be adapted for poor urban communities very simply as follows: each community forms a cooperative (or ‘condominium’) and chooses the level of water supply service that it is willing and able to pay for. Thus, in any one urban situation, there would be a mix of:

- standpipe cooperatives: groups of households served by community-managed standpipes (one or two per cooperative; the supply is not metered); the member households would pay a nominal tariff – for example, 1–2% of the local minimum wage, [standpipes are often thought to be a very inferior level of water,
- yard-tap cooperatives: groups of households served by household-level yard taps; the supply would be unmetered and each member household would pay a minimum tariff of, say, 5% of the local minimum wage; and
- multiple-tap in-house cooperatives: groups of non-poor households each with a multiple-tap in-house supply; the supply to the cooperative would be metered and charged for on the standard domestic tariff.

The public supply is to a single point for each cooperative (or housing block) and the member-households are responsible for all in-block pipework and connections (normally they would engage a local contractor to do this), although for standpipe cooperatives the water supply agency may choose to install the standpipes itself as a 'social' service to the poor and the very poor. The water supply authority bills the cooperative, not individual member-households, and therefore the cooperative is responsible for collecting each member-household's contribution every month and paying the water bills. If the water-supply agency really is pro-poor then it should consider spreading the annual payment from standpipe and yard-tap cooperatives over 10 months, rather than 12, so that no charge is payable in the months of the major local festival and the start of the school year when households have significant additional expenditure.

Standpipes are often thought to be a very inferior water-supply service level. This is commonly true when they are installed as a free so-called 'social service' by the local water-supply agency at a rate of one per many hundreds of people and without proper maintenance,<sup>[21]</sup> but it is not true when – as in a well designed standpipe-cooperative programme – a few standpipes serve a relatively small group of households. Properly managed standpipes are, without doubt, an excellent means of getting piped water to the urban poor.<sup>[22-23]</sup>

If the sanitation option in a low-income high-density area is a community-managed sanitation block (section 3.3.4) – which has its own piped water-supply connection – then there is in effect already a functioning water-and-sanitation cooperative which can extend its piped supply to private standpipes within its area as it sees fit for the greater convenience of its member-households.

Please click the advert



360°  
thinking.

**Deloitte.**

Discover the truth at [www.deloitte.ca/careers](http://www.deloitte.ca/careers)

© Deloitte & Touche LLP and affiliated entities.

If the water-supply agency, backed by the town/city council, decides that all urban communities in that town/city should receive condominial supplies and if some non-poor communities refuse to participate, they should pay significantly more for their water. However, many non-poor urban communities are already paying condominial charges (for example, residents of apartments in high-rise blocks pay for common services such as the cleaning and lighting of communal areas, the operation of elevators, and garden and swimming pool maintenance), so one extra condominial payment should not be a real problem.

An alternative model which has met with some success in Africa and some parts of Latin America and Asia is the sale of water at a discounted bulk tariff to a third-party private provider (often a community-based entrepreneur) who then on-sells the water to local households. The third-party provider has the option of selling water at a fixed point (usually a water kiosk) or installing a network and selling water to individual households usually through a metered connection. This model works well for large communities where the formation of condominial cooperatives is more challenging. Examples include regulated kiosks in Maputo, Mozambique, and community-based water and sanitation entrepreneurs operating in Nairobi Kenya.<sup>[24]</sup> Careful regulation is needed to ensure that the interests of poor customers are protected and that prices do not rise<sup>[25,26]</sup>. The affordability, and therefore the success of the model relies on the main water service provider being willing to forego the full domestic tariff rates when selling water to third-party providers. Usually this should be an attractive option, given that the alternative is often illegal tampering with pipelines and theft of water.

#### 4.2.3 Expected health improvements

Getting piped water into low-income urban areas by a well designed programme of either standpipes or yard taps (as in standpipe and yard-tap cooperatives) is a really good way to improve the health of the residents of these areas – provided, of course, adequate sanitation (section 3.3) is in place as well. For example, a cost-effectiveness analysis done in Uganda showed that, for a poor urban town, only in-house piped water supplies significantly impacted diarrhoea prevalence, although the provision of community standpipes resulted in the largest reduction in the burden of diarrhoeal disease at the lowest cost.<sup>[27]</sup> More generally, the health benefits of water supplies follow a ‘threshold-saturation’ pattern:<sup>[28]</sup>

- in extremely poor communities water supply improvements have little, if any, effect on health (sufficient quantities of more nutritious food, for example, are likely to have a much greater effect);
- as communities begin to develop (i.e., once they have reached the ‘threshold’) water supply improvements start to produce health benefits; and
- when communities are quite well developed (i.e., they are past the ‘saturation’ point) water supply improvements do not bring any further health benefits.

Recent work in Brazil has found that the impact of water supply improvements on reducing infant mortality rates follows this threshold-saturation pattern very closely, and that “from the perspective of health outcomes, new piped water resources should be targeted to the most disadvantaged communities”.<sup>[29]</sup>

## References

1. J Davis and R Lambert *Engineering in Emergencies: A Practical Guide for Relief Workers* 2<sup>nd</sup> ed. Intermediate Technology Publications, London, 2002; information available online at: <http://www.redr.org/redr/support/resources/EinE/EinE.htm>
2. A Twort, F Law, F Crowley and D Ratnayaka *Water Supply, 4th ed.* Edward Arnold, London, 1994
3. The Sphere Project *The Sphere Handbook, Humanitarian Charter and Minimum Standards in Disaster Response*; 2004 edition. The Sphere Project, Geneva, Switzerland, 2004; available online at: <http://www.sphereproject.org/>
4. S Cairncross & R Feachem *Environmental Health Engineering in the Tropics, An Introductory Text, Second Edition.* Wiley, Chichester, 1993; available to purchase at: <http://eu.wiley.com/WileyCDA/WileyTitle/productCd-0471938858.descCd-tableOfContents.html>
5. E Hofkes, (Editor), L Huisman, B Sundaresan, J De Azevedo Netto and J Lanoix *Small Community Water Supplies, Technical Paper Series No.18*, International Reference Centre for Community Water Supply and Sanitation (IRC), Wiley, Chichester, 1998
6. G Howard & J Bartram *Domestic Water Quantity, Service Level and Health WHO/SDE/WSH/03.02* World Health Organisation, Geneva, 2003; available online at: [http://www.who.int/water\\_sanitation\\_health/diseases/en/WSH0302.pdf](http://www.who.int/water_sanitation_health/diseases/en/WSH0302.pdf)
7. WHO *Guidelines for Drinking-water Quality*, 4th edition, WHO Geneva, 2011; available online at: [http://www.who.int/water\\_sanitation\\_health/publications/2011/dwq\\_guidelines/en/index.html](http://www.who.int/water_sanitation_health/publications/2011/dwq_guidelines/en/index.html).
8. S Gundry, J Wright & R Conroy *A systematic review of the health outcomes related to household water quality in developing countries.* J Water & Health 2(1):1-13, 2004; available online at: <http://www.ncbi.nlm.nih.gov/pubmed/15384725>
9. L Fewtrell, R Kaufmann, D Kay, W Enanoria, L Haller & J Colford J *Water, sanitation, and hygiene interventions to reduce diarrhoea in less developed countries: a systematic review and meta-analysis.* Lancet Infect. Dis. 5:42-52, 2005; available in report format online at: [http://www.globalhandwashing.org/resources/multimedia-pdf/9.%20Water\\_Sanitation\\_Hygiene\\_Interventions\\_Diarrhea.pdf](http://www.globalhandwashing.org/resources/multimedia-pdf/9.%20Water_Sanitation_Hygiene_Interventions_Diarrhea.pdf)
10. <http://www.sodis.ch>
11. WELL *Technical Briefs* available online at <http://www.lboro.ac.uk/well/resources/technical-briefs/technical-briefs.htm>
12. <http://www.auick.org/database/apc>
13. <http://www.sgp.undp.org>
14. WaterAid *Technology Notes*, WaterAid, London, 2007; available online at: [http://www.wateraid.org/uk/what\\_we\\_do/sustainable\\_technologies/technology\\_notes/default.asp](http://www.wateraid.org/uk/what_we_do/sustainable_technologies/technology_notes/default.asp)
15. *Progress on Sanitation and Drinking-water: 2010 Update*, World Health Organization & UNICEF, Geneva, 2010; available online at: [http://www.who.int/water\\_sanitation\\_health/publications/9789241563956/en/index.html](http://www.who.int/water_sanitation_health/publications/9789241563956/en/index.html).
16. *World Urbanization Prospects: The 2009 Revision – Highlights*, Department of Economic and Social Affairs, Population Division, United Nations, New York, 2008; available online at: [http://esa.un.org/unpd/wup/Documents/WUP2009\\_Highlights\\_Final.pdf](http://esa.un.org/unpd/wup/Documents/WUP2009_Highlights_Final.pdf).
17. *Providing safe drinking water to developing nations*, transcript of a National Public Radio programme, 2003; available online at: [http://www.unesco.org/water/wwap/news/national\\_public\\_radio.shtml](http://www.unesco.org/water/wwap/news/national_public_radio.shtml).
18. AC McIntosh, *Asian Water Supplies: Reaching the Urban Poor*, Asian Development Bank, Manila, 2003; available online at: [http://www.adb.org/Documents/Books/Asian\\_Water\\_Supplies/default.asp](http://www.adb.org/Documents/Books/Asian_Water_Supplies/default.asp).

19. DD Mara & GP Alabaster, A new paradigm for low-cost urban water supplies and sanitation in developing countries, *Water Policy* 2008, **10** (2), 119–129; available online at: <http://www.personal.leeds.ac.uk/~cen6ddm/pdfs%202006+/0711.pdf>.
20. JC Melo, *The Experience of Condominial Water and Sewerage Systems in Brazil*, Water and Sanitation Program, Washington, DC, 2005; available online at: <http://www.wsp.org/UserFiles/file/BrasilFinal2.pdf>.
21. S Keener, M Luengo & S Banerjee, *Provision of Water to the Poor in Africa: Experience with Water Standposts and the Informal Water Sector*, World Bank, Washington, DC, 2010; available online at: <http://go.worldbank.org/KP718MWH00>.
22. R Franceys & E Gerlach, Standpipes and beyond – A universal water service dynamic, *Journal of International Development* 2009, **22** (4), 455–469; abstract available online at: <http://dx.doi.org/10.1002/jid.1567>.
23. SV Berg & S Mugisha, Pro-poor water service strategies in developing countries: Promoting justice in Uganda's urban project, *Water Policy* 2010, **12** (4), 589–601; abstract available online at: <http://www.iwaponline.com/wp/01204/wp012040589.htm>.
24. A Peal and B Evans (2010) *Breaking Barriers in Water and Sanitation Service Delivery to Informal Settlements – Case Study of the Mukuru Model* Practical Action Publishing available online at: <http://practicalaction.org/docs/Breaking-barriers-in-water-and-sanitation-service-delivery-to-informal-settlements-Mukuru-Model-Full-Report.pdf>
25. Evans, B.E., Brocklehurst, C, and Kariuki, R.M. (2002) *New Designs for Water and Sanitation Transactions: Making Private Sector Participation Work for the Poor* World Bank Water and Sanitation Programme and PPIAF available online at: <http://www.personal.leeds.ac.uk/~cenbee/Publications/New%20Designs.pdf>
26. Trémolet, S and C Hunt *Taking Account of the Poor in Water Sector Regulation* Water Supply & Sanitation Working Notes Note No. 11, August 2006 World Bank available online at: <http://vle.worldbank.org/bnpp/files/TF050345reformofurbanwatersupplyandsanitation11.pdf>



MSM

MAASTRICHT SCHOOL OF MANAGEMENT

Increase your impact with MSM Executive Education



For almost 60 years Maastricht School of Management has been enhancing the management capacity of professionals and organizations around the world through state-of-the-art management education.

Our broad range of Open Enrollment Executive Programs offers you a unique interactive, stimulating and multicultural learning experience.

**Be prepared for tomorrow's management challenges and apply today.**

For more information, visit [www.msm.nl](http://www.msm.nl) or contact us at +31 43 38 70 808 or via [admissions@msm.nl](mailto:admissions@msm.nl)

the globally networked management school

Please click the advert



27. I Kasirye, *Household Environmental Conditions and Disease Prevalence in Uganda: The Impact of Access to Safe Water and Improved Sanitation on Diarrhea*, Centre for Environmental Economics and Policy in Africa, University of Pretoria, Pretoria, 2010; available online at: <http://hdl.handle.net/10625/43094>.
28. HR Shuval, RL Tilden, BH Perry & RN Grosse, Effect of investments in water supply and sanitation on health status: a threshold-saturation theory, *Bulletin of World Health Organization* 1981, **59** (2), 243–248; available online at: [http://whqlibdoc.who.int/bulletin/1981/Vol59-No2/bulletin\\_1981\\_59\(2\)\\_243-248.pdf](http://whqlibdoc.who.int/bulletin/1981/Vol59-No2/bulletin_1981_59(2)_243-248.pdf).
29. S Gamper-Rabindran, S Khan & C Timmins, The impact of piped water provision on infant mortality in Brazil: A quantile panel data approach, *Journal of Development Economics* 2010, **92** (2), 188–200; available online at: <http://dx.doi.org/10.1016/j.jdeveco.2009.02.006>.

### Further reading

E Baumann, *Low Cost Handpumps Rural Water Supply Network*, Zurich, 2011; available online at: <http://www.rwsn.ch/documentation/prcollector.2009-04-05.2482958002/skatdocumentation.2011-07-01.0268979788>

E Baumann & K Erpf, *Rural Water Supply - Technology Options (Handpumps, Mechanised Pumps, Surface Water)* Rural Water Supply Network, Zurich, 2005; available online at: <http://www.rwsn.ch/documentation/skatdocumentation.2006-03-02.8791676905>

CG Victora, PG Smith, JP Vaughan, LC Nobre, C Lombard & others, Water supply, sanitation and housing in relation to the risk of infant mortality from diarrhoea, *International Journal of Epidemiology* 1988, **17** (3), 651–654; available online at <http://dx.doi.org/10.1093/ije/17.3.651>.

T Merrick, *The Effect of Piped Water on Early Childhood Mortality in Urban Brazil 1970–1976*, World Bank, Washington, DC, 1983; available online at: <http://go.worldbank.org/ZPGRKBPO30>.

D Whittington & WM Hanemann, *The Economic Costs and Benefits of Investments in Municipal Water and Sanitation Infrastructure: A Global Perspective*, University of California, Berkeley, 2006; available online at: <http://ageconsearch.umn.edu/bitstream/7159/2/wp061021.pdf>

### Chapter 4: Key Messages

1. Improving access to water greatly increases the amount that a person will use and this will have a greater benefit on their health than improving only the quality of their existing supply source.
2. Wherever possible groundwater should be the preferred source for a rural water supply scheme. Surface water sources are much more likely to be polluted and are more unreliable, on account of being more subject to seasonal variations in flow.
3. Rainwater can be a valuable subsidiary water source and can be used to supplement a possibly inadequate or unreliable primary supply source.
4. In urban areas the poor usually pay significantly more than the rich for very poor levels of water supply service
5. There is an urgent need for a new paradigm of urban water supply service delivery whereby service providers sell water to groups of consumers organised either through cooperative groups or as clients of third-party service providers.
6. The costs of condominal water supplies are significantly lower than the costs of conventional supplies and the health gains are significant when compared to existing unregulated supplies.


# 5 Programming and Planning

Delivering adequate water and sanitation services is not simply a matter of building infrastructure. As we have already seen, water supply, sanitation and handwashing are all important in the management of water- and excreta-related diseases. Sanitation and handwashing in particular usually require significant changes in behaviour to be effective (for example shifting habits from defecating in the open to using a latrine, or washing hands with soap at important times). What is more, sanitation and water services need to be kept running over many years and require constant inputs to ensure that this happens. In rural areas communities themselves are usually important in ensuring that this happens whilst in urban areas, effective city-wide management is required. Furthermore, in urban areas community systems need to be linked to city-wide services. Finally both sanitation and water supply have strong gender and power dimensions; interventions may improve equity but can also inadvertently result in entrenching the position of the strongest elements in society to the detriment of the less powerful. The provision of water and sanitation is thus a much larger and more complex challenge than it may first appear.


Please click the advert







**See the light!**  
**The sooner you realize we are right,  
 the sooner your life will get better!**

A bit over the top? Yes we know!  
 We are just that sure that we can make your  
 media activities more effective.



Get "Bookboon's Free Media Advice"  
 Email [kbm@bookboon.com](mailto:kbm@bookboon.com)



## 5.1 Getting Started - Understanding where the constraints lie

Designing a water supply, sanitation and hygiene programme is about more than just construction. The exact scope of a programme is highly dependent on the local circumstances. The nature of the technical problem to be solved, along with social and economic characteristics of target communities all play a part in determining the optimum intervention. The first step in good programming is to gain an accurate picture of the current situation. This can be done through a combination of reviewing existing documentation, physical inspections and interactions with householders and other local stakeholders. Depending on the stage, scale and complexity of the planned intervention this may take a few days or many months, but the broad areas for a typical assessment will usually be similar. An indicative checklist is shown in **Table 5.1** but other things could be added to this list.

A crucial tool is a good map of the area. These days, good maps can usually be obtained or created from web-based resources such as Google Maps combined with locally available technical maps and drawings. This type of mapping should always be checked against a visual inspection of the area.

**Table 5.1: Checklist for Programming and Planning Preparation**

	Technical issues	Socio-economic issues
General		Population size, age and gender distribution Household living patterns Wealth/ income/ production (incidence of poverty, depth of poverty, social and gendered dimensions of poverty) Other dimensions of social equity (ethnicity, disability, age ....) Social institutions (can existing social structures be used to organise WS?) Legal framework for forming committees/ social enterprises/ holding bank accounts etc
Water supply	Potential sources Yield Water quality Pollution risks  Appropriate/possible levels of service demand Domestic Agriculture (domestic or fields) Livestock Industrial/ productive Potential power supplies Available/ typical technologies and their costs Availability of spare parts/ technical support	Willingness-to-pay  Preferences for level of service

Sanitation	Existing sanitation facilities (households and institutions) Options for re-use or disposal of faecal sludge Market for goods and services (are there individuals or other agents with the skills and knowledge to deliver sanitation services?)	Sanitation practices (squatting/ sitting; washing/ wiping) Knowledge and attitudes to sanitation and reuse Experience of previous sanitation programmes Willingness to pay for sanitation
Hygiene	Availability of water/ soap for hygiene Market for hygiene goods and services	Knowledge and attitudes to hygiene practices Potential motivators for behaviour change (people and ideas)

## 5.2 Participatory Planning Tools

Much of the information required may need to be obtained through interactions with community members. Care is needed to ensure that information gathered from the community is representative and meaningful. Brief visits and quick discussions with people met casually in the market place are usually insufficient to glean an accurate picture of community dynamics and experiences. A group of techniques known as Participatory Rural Appraisal (PRA) form the backbone of most of the accepted techniques for community engagement.<sup>[1]</sup>

PRA is primarily concerned with empowering communities to be part of the process of information gathering (compared to earlier techniques which tended to focus on 'extracting' information.) PRA techniques are designed to be extremely inclusive and take into account the fact that many participants may be unable to read or write (so they make use of pictures, mapping and counting using locally-available materials such as stones or sticks). In general, these approaches are useful for encouraging the involvement of women, children, the elderly and people with disabilities who in some cultures may be reluctant or unable to express their views. Participatory tools in PRA have been developed into water and sanitation-specific tools such as:

- Water resource and use-mapping;
- Wealth/access mapping;
- Card sorting (usually using pictures of 'desirable' and 'undesirable' situations);
- Pocket voting (where community members can 'vote' for the most urgently-needed interventions); and
- Causal linkage diagramming.

Specific methodologies exist which can be used as part of the planning process for water supplies and sanitation (see **Figure 5.1**). These include SARAR (Self-esteem, Associative Strengths, Resourcefulness, Action-planning and Responsibility) and MPA (the Methodology for Participatory Assessments).<sup>[2,3,4]</sup>



Please click the advert

**I WANT TO CHANGE DIRECTION,  
AND THE WORLD.**

**GOT-THE-ENERGY-TO-LEAD.COM**

We believe that energy suppliers should be renewable, too. We are therefore looking for enthusiastic new colleagues with plenty of ideas who want to join RWE in changing the world. Visit us online to find out what we are offering and how we are working together to ensure the energy of the future.

**RWE**  
The energy to lead

Download free ebooks at [bookboon.com](http://bookboon.com)



**Figure 5.1: Participatory Planning Tools.** PRA often employ visual tools to ensure that illiteracy is not a barrier to participation. Use of pictures (for sorting or pairing) and mapping are often good ways to get groups to discuss difficult topics. In the bottom image, a group discusses open defecation using a physical map of the community.

### 5.3 Inducing Behaviour Change and Promoting Hygiene

As we have seen changing key hygiene behaviours can often be an essential element in achieving health gains in poor communities. Most of the evidence suggests that health is rarely the driver for changes in hygiene behaviours; pride, status, convenience and modernity are usually seen as stronger reasons to change behaviours.<sup>[5]</sup> Older approaches which largely relied on instruction about the health risks of not practising safe hygiene have now largely been replaced by approaches which build on people's own motivations and interests.

Hygiene promotion approaches can broadly be split into two categories – those which aim to change community-wide hygiene behaviours in the broadest sense and those which target one specific behaviour.

In the first group are a family of approaches that aim to empower community members to solve their own hygiene (and often sanitation) challenges. The oldest of these is called Participatory Hygiene and Sanitation Transformation (PHAST).

<sup>[6]</sup> PHAST encourages the participation of individuals in a group process of:

- Problem identification;
- Problem analysis;
- Planning for solutions;
- Selecting options;
- Planning new facilities;
- Planning for Monitoring and Evaluation; and
- Participatory evaluation.

Other techniques use a similar programme cycle but are less formulaic. In Zimbabwe, Community Health Clubs help to promote a 'culture of health' by bringing together groups from within the community who meet regularly to hold facilitated discussions about key hygiene and health issues. Dr Juliet Waterkeyn, who developed the CHC concept in Zimbabwe, describes the community learning process as follows:<sup>[7]</sup>

“Each weekly meeting of health club members focused on one topic, debating common problems, prompted by the participatory PHAST activities. Through repeated interaction a strong and informed leadership, elected by the members, emerged in most clubs before any implementation (such as latrine construction) took place. All health clubs had executive committees, constitutions and annual elections. Application of knowledge gained was emphasised and 'homework' was agreed at every session with members pledging small home improvements and behaviour changes to be effected by the following week. These changes included a cover for the drinking water, a ladle to take water, the construction of a garbage pit, a pot drying-rack and a handwashing facility. Home visits between members were arranged to monitor one another's progress. Each club produced its own health songs which were sung at each session and dramas depicting local health issues were developed for other clubs, visitors and for the schools. Health slogans punctuated each session, reinforcing key messages and providing resolve and focus to the group in a traditional manner. To complete the course of 20 sessions took between 6 and 8 months of weekly attendance.”



CHCs have been extremely successful in sanitation promotion and latrine construction (the latrines were VIP latrines – see section 3.1.3): for example, in Zimbabwe sanitation coverage was 2% in a district not having CHCs but 43% in a CHC project area, with the balance of 57% practising ‘cat sanitation’ (i.e., digging a small hole before defecation and then covering the faeces afterwards – as a cat does).

CHCs are now used in many countries in Africa and Asia.<sup>[8,9,10]</sup> A combination of specialist information, facilitated problem solving and peer pressure seems to be effective in changing household and personal behaviours.<sup>[11]</sup>

Schools are also an important locus for changing hygiene behaviours. Many observers note the effectiveness of children as ‘agents of change’ in the family. WASH in Schools, focusing both on promoting behaviour change through teaching but also by demonstrating the benefits in a school which has good sanitation and hygiene facilities, has become a popular element in many water, sanitation and hygiene programmes and its effectiveness seems to be quite high<sup>[12,13]</sup>. In one evaluation classes where more girls washed their hands and used the toilet tended to have better attendance. Households in communities with a WASH in Schools programme appeared to be twice as likely to have soap in toilets at home as control communities<sup>[14]</sup>.

In addition to these community-based approaches, marketing approaches have been growing in popularity in recent years. These tend to use private-sector marketing techniques to promote one specific behaviour (typically handwashing with soap or point-of-use water treatment). Marketing tends to use a blend of mass media, and face-to-face methods and is tailored to the specific cultural context in which it operates. Crucially marketing campaigns are based on formative research to identify critical drivers for behaviour change.

Please click the advert

## Who is your target group? And how can we reach them?

At Bookboon, you can segment the exact right audience for your advertising campaign.

Our eBooks offer in-book advertising spot to reach the right candidate.



Contact us to hear more  
[kbm@bookboon.com](mailto:kbm@bookboon.com)










Download free ebooks at [bookboon.com](http://bookboon.com)

## 5.4 Creating Sanitation Markets

Throughout much of the 1980s, 1990s and early 2000s sanitation programmes in many countries focused on the provision of toilets, usually through direct implementation by government, and commonly with a large subsidy element to pay for costs of construction. Public-good and equity arguments have been used to justify this approach. Regrettably however, many of these national programmes had limited success, with a poor take up rate, evidence of poor targeting of subsidies and limited reach. Thus, although the case for public engagement in sanitation is compelling, new programmes have tended to work in alternative ways and seek to make better use of public funds.

Generally the 'new' generation of approaches can be divided into two groupings: firstly those that deal with community-wide sanitation and are based on 'participatory' approaches (see **Section 3.1.1**); and secondly those that use a social marketing approach to analyse and intervene in the supply and demand of goods and services.

Initially building sanitation markets was seen as primarily a matter of establishing entities (usually social enterprises and sometimes small private entrepreneurs) to provide sanitation goods and services. Training (both technical and business training) was provided and it was hoped that these small businesses would rapidly become viable and independent. Nowadays sanitation marketing is seen as a much more complex business. It requires the development of appropriate products and appropriate financial instruments which match the demand coming from communities.<sup>[15]</sup> If we think of sanitation and hygiene behaviours as a continuous process of change (sometimes referred to as a 'ladder') it becomes easier to understand that sanitation markets need to be robust, flexible and adaptive if they are to provide what is needed (Figure 5.1).

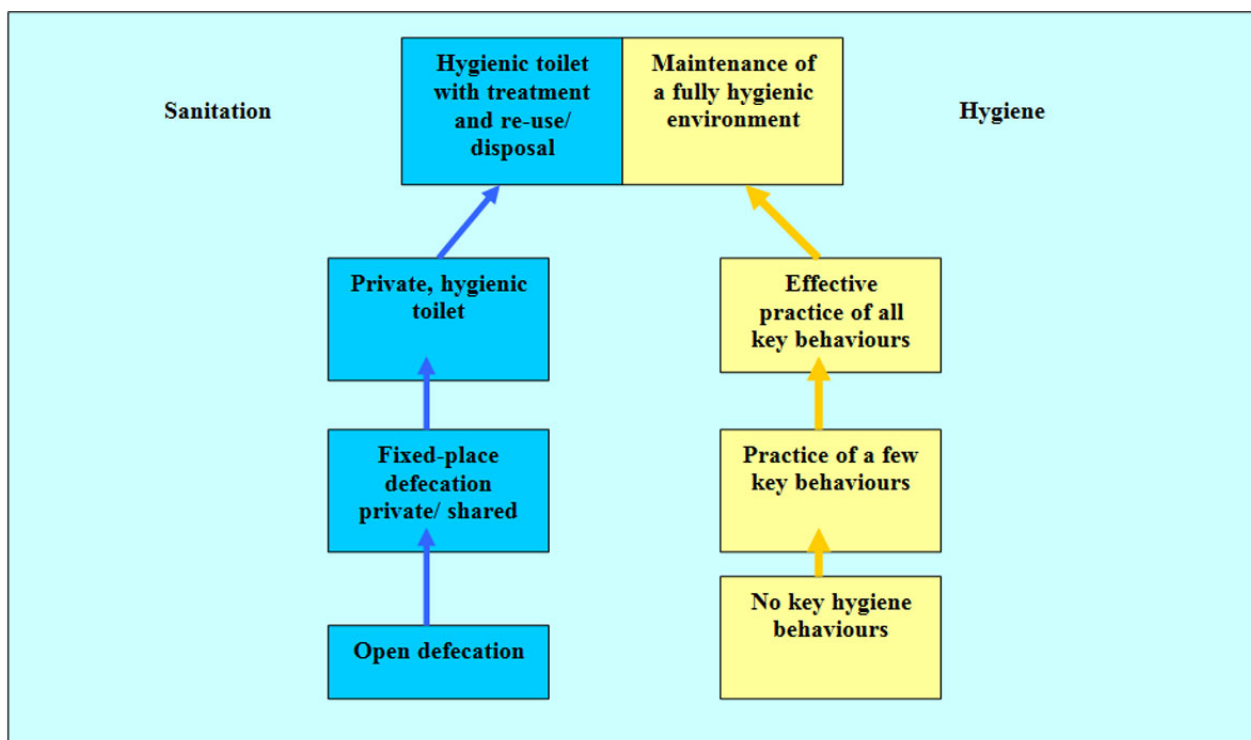


Figure 5.1 Dynamic sanitation and hygiene behaviour change<sup>[1]</sup>

Broadly sanitation marketing programmes have four steps:

- Formative research (to identify the behaviour change required and the likely drivers of that change);
- Development of a marketing strategy;
- Development of a communications campaign; and
- Implementation

Experience with sanitation marketing is growing fast (see Figure 5.2). A number of very useful online materials exist to help develop sanitation marketing interventions.<sup>[15]</sup>



**Figure 5.2 Sanitation marketing** This picture is just one of many images employed in Himachel Pradesh, India to promote the Total Sanitation campaign there, Under the slogan “I Selected Safety; I Got Myself A Toilet” people from all sections of society demonstrate their pride in owning a toilet. The campaign also uses kits and games in schools and distributes thousands of toilet catalogues as well as scripting and airing its own radio soap opera. <sup>[15]</sup>

Please click the advert

## 5.5 Management options for rural water supplies

While they vary considerably, rural communities are often remote and scattered. Many are far from the capital city and even remote from district administrative centres and market towns. In such communities specific arrangements must be made to ensure that there is adequate diesel fuel to operate pumps, or that the electricity bill or the pump operator are paid on time. Small repairs to channels or pipelines may be needed and from time-to-time pumps may require servicing or an overhaul. In mechanised schemes, if the pump fails there will be no water at all. During the late 1970s, the 1980s and into the 1990s much emphasis was placed on the need for Village-level Operation and Maintenance (VLOM). A number of handpumps were developed with the specific objective of being easy to maintain and operate by village level technicians (these are often referred to as VLOM handpumps). However the experience of community management has been mixed and recent research suggests that at significant percentage of, handpumps in Africa are non-functional despite decades of effort to build up community management capacity<sup>[16]</sup> (see Figure 5.1).

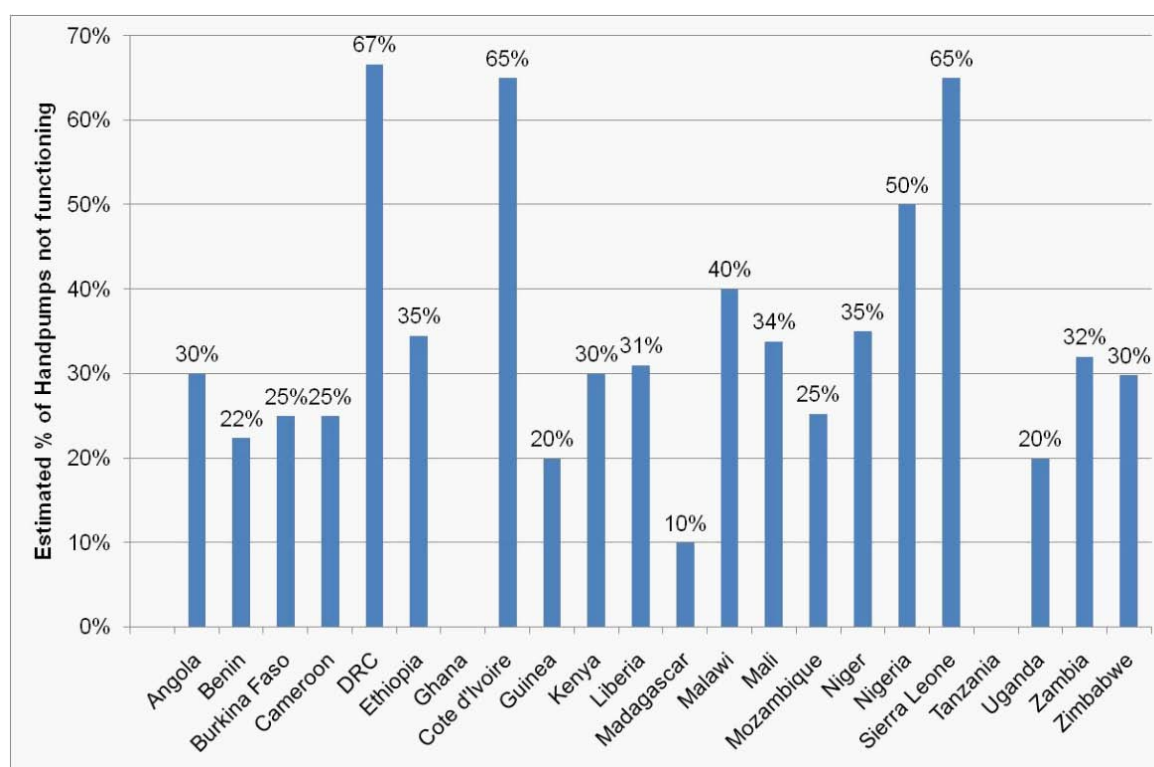


Figure 5.1: Proportion of non-functional handpumps in selected countries

In addition to the simple model of village-level maintenance there are a number of more sophisticated options for management of rural water supplies including:

**Public-sector management:** Traditionally maintenance of rural water supplies has been provided by the staff of national or decentralised public health or public works agencies. Typically district engineers are based in a local district headquarters. Their salaries are paid from the general budget and they are expected to respond to requests from communities for assistance when their water systems break down. Funds for general maintenance and small repairs are provided through the normal public-sector budget.

In theory this approach has a number of advantages including the availability of skilled and trained staff with access to budgets. Usually it also means that the same organisation and probably the same engineers who designed the system are responsible for its operation. However, the reality is often different. Public sector budgets for operations are notoriously unreliable, particularly in remote districts. Funds may be allocated late in the financial year or not at all, and are often inadequate to do more than pay the engineers' and technicians' salaries. There is low accountability (communities have little influence over the performance of the engineers) and schemes which are farthest from the district office may get least attention. Poorly paid and working far from headquarters, the best engineers are rarely tempted to compete for these positions. With limited resources and few incentives to perform many district water offices do little to help communities; and the sight of broken pumps and damaged equipment lying unrepaired in the office yard is not uncommon.

Community self-management: The alternative to this traditional public-sector model is the water user committee or local community self-management. Under this model the community usually forms a committee to run the scheme and users pay a small periodic fee which is kept in a general fund to cover operations and maintenance. Sometimes these funds are used to pay the salary of a pump operator.

This approach has several important advantages: the users have control and can communicate problems quickly to the committee or the operator, accountability is higher (if the committee fails to perform everybody knows) and there should be sufficient funds available for regular ongoing costs. However, there are also disadvantages. The most obvious one is a lack of appropriate local skills which can cause particular problems when major repairs are needed. At such times funds may also be short (people may be unwilling or unable to build up sufficient deposits in the community bank account on the off chance that they will be needed later and credit may not be available locally). Committees may have limited or no access to overall planning information (for example regarding water resources). Finally this approach places a burden of responsibility and time requirements on community members; in rural communities, particularly at busy times of the farming year, this may be untenable. Nonetheless in some countries and some situations community self-management has proved highly successful. Rural Kenya has numerous community-managed schemes, some of which are extremely large and complex (see, for example, **Box 5.1**).

**Box 5.1: Good practice in Community Water Supply: The Case of Murugi Mugumango<sup>[17]</sup>**

This scheme was started in the 1980s when five small schemes amalgamated to form Murugi Water Project. In 1983 Murugi merged with Mugumango Water Project to form the Murugi Mugumango Water Society. Construction of the Project was supported by the Canadian Hunger Foundation (CHF) who also hired a local NGO to train the committee and operations staff. Currently the Project serves two locations with an area of around 140 km<sup>2</sup> through 168 km of main lines, 580 km of branch lines and 12 storage tanks.

The scheme is managed by an elected management committee. The committee employs 18 staff who are supported when required by contractors for specialized services. So far the project has 2,883 registered members out of whom 2,423 have individual metered connections. The project has adopted a commercial approach in its affairs and collects around KES 200,000 monthly against operational costs of around KES 150,000. The scheme thus appears to be financially viable through the tariff. An external auditor audits the scheme finances annually and the audit report is presented to members during the annual general meeting. In moving towards increased sustainability the scheme is embarking in strategic planning exercises. The scheme regularly hosts management committees and staff from other projects within the country as well as from outside the country who come to learn about its management systems. Such good practice examples provide opportunity for inter scheme learning exchanges to increase sustainability in the sector as a whole. Indeed the management committee has plans to the make the project a training centre for community projects in the region.

**Do your employees receive the right training?**

Bookboon offers an eLibrary with a wide range of Soft Skill training & Microsoft Office books to keep your staff up to date at all times.



Contact us to hear more  
[kbm@bookboon.com](mailto:kbm@bookboon.com)



Please click the advert



Semi-professional management or regional schemes: In this model a group of communities (or local government) collect fees and retain the services of a local circuit rider/ management company or similar to support them in running their water supply.

The advantages of this grouping together is that it enables community-managed schemes to access support, skills and knowledge they otherwise would be unable to afford. Local communities retain some control but combine their 'buying power'. However, the model does have disadvantages. The transactions costs can be high (it is not always easy for communities to work together) and it may be hard to coordinate between them to get value for money. Information asymmetries may also exist resulting in private sector service providers being able to overcharge for their services. In some countries, private service providers may simply not be available in the market.

## 5.6 Urban Water and Sanitation Planning

In contrast to rural areas, service delivery in urban areas is rarely under the control of local communities. Choices made at the local level are profoundly influenced by the city at large – water supply is dependent on bulk water supplies reaching the city often from far away and sanitation depends on there being somewhere to dispose of the waste; communities are not therefore in a position to self-supply as is often the case in remote rural areas. At the same time, many cities in the global south are growing rapidly (see **Section 3.3.1**) but have a low taxation base and limited funds. The planning of water supply and sanitation is often haphazard and highly influenced by 'projects' imposed by central government or donors. Systematic planning is rare, and in any case, the needs of informal settlements, peripheral growth areas and slums are rarely high on the political priority list. The result is often chaotic and highly unsatisfactory. Communities are often reliant on illegal water sources or unregulated private vendors and sanitation is most often absent.

Urban water and sanitation is thus characterized by a split between the planning, implementation and operation of the 'formal' network services (typically water networks and waterborne sewerage) serving very small parts of the planned area of the city and the ad hoc provision of services to most of the rest of the city, including unplanned, informal and illegal settlements. While a number of NGO-led and CBO-led initiatives have worked hard to develop approaches which work in these informal settlements, few have managed to forge a constructive dialogue with city managers. Meanwhile much of the planning for the formal system fails to take into account the needs, capacities and constraints of the urban poor <sup>[1]</sup>.

Many of the most promising options for urban service provision involve the linking together of the city network to a series of local service providers (see for example Sections 3.3.2 and 4.2.2). In these approaches cities enter into formal arrangements with third-party providers (either community cooperatives or small scale independent (private) providers to deliver services over the 'last mile' to the household door. This approach is appealing to many city authorities who lack the manpower or skills to work in dense informal settlements. Other promising options include the formalisation of informal service providers such as pit-emptiers, to ensure that they provide an adequate service at a regulated price in return for being able to run legal businesses.



Whatever service delivery model is adopted good planning requires that local demands and needs are balanced with city-wide interests. The International Water Association developed a useful framework for city-wide planning of sanitation (which could apply equally well to water supply). In the Sanitation 21 framework the incentives and interests of stakeholders are taken into account explicitly. This highlights very quickly the tensions which exist for example between national environmental regulators who are interested in preserving water quality in rivers and aquifers downstream of the city and inhabitants of slums who are only interested in reducing the flooding and gross contamination in their own neighbourhood.<sup>[20]</sup>

The problem is that we don't as yet have many good examples of cities who have successfully overcome these tensions in the face of rapid urbanisation and increasing informality. Often the problems of the city are so overwhelming that sanitation cannot gain the attention it needs. Furthermore it is the poorest who suffer most when sanitation services are not provided and they often have the least political power. There is no doubt that delivering sufficient safe water and adequate sanitation to the growing urban populations of Africa and Asia remains one of the biggest challenges of this century.

Please click the advert



www.job.oticon.dk

**oticon**  
PEOPLE FIRST

## References

1. A Peal, B Evans & C van der Voorden, *Hygiene and Sanitation Software: An Overview of Approaches*, Water Supply & Sanitation Collaborative Council, Geneva, 2010; available online at: [http://www.wsscc.org/fileadmin/files/pdf/publication/Public\\_Funding\\_for\\_Sanitation\\_the\\_many\\_faces\\_of\\_sanitation\\_subsidies.pdf](http://www.wsscc.org/fileadmin/files/pdf/publication/Public_Funding_for_Sanitation_the_many_faces_of_sanitation_subsidies.pdf).
2. World Bank, *The World Bank Participation Sourcebook*, World Bank, Washington, DC, 1996; available online at: <http://lnweb90.worldbank.org/EXT/epic.nsf/ImportDocs/531D92F255DF6E6C8525739F00788A58?opendocument&query=CO>
3. R Dayal, C van Wijk and N Mukherjee *METGUIDE Methodology for Participatory Assessments with Communities Institutions and Policy Makers. Linking Sustainability with Demand, Gender and. Poverty Water and Sanitation Program*, Washington DC, 2000; available online at: [http://bscw.ihe.nl/pub/nj\\_bscw.cgi/d2220629/DayalMethodologyforParticipatoryAssessments.pdf](http://bscw.ihe.nl/pub/nj_bscw.cgi/d2220629/DayalMethodologyforParticipatoryAssessments.pdf)
4. N Mukherjee and C van Wijk *Sustainability planning and monitoring in community water supply and sanitation: a guide on the methodology for participatory assessment (MPA) for community-driven development programs* World Bank. Washington, DC, 2003; available online at: [http://www.wsp.org/wsp/sites/wsp.org/files/publications/328200785925\\_sustainplanningandmonitoring.pdf](http://www.wsp.org/wsp/sites/wsp.org/files/publications/328200785925_sustainplanningandmonitoring.pdf)
5. B Scott *Social Marketing: A Consumer-based approach to promoting safe hygiene behaviours. WELL Factsheet* WEDC and LSHTM, UK, 2005; available online at: <http://www.lboro.ac.uk/well/resources/fact-sheets/fact-sheets-htm/Social%20marketing.htm>
6. R Sawyer, M Simpson-Hébert and S Wood *PHAST Step-by-Step Guide: a participatory approach for the control of diarrhoeal disease* WSP/World Bank, UNDP and WHO. Geneva, Switzerland, 1998; available online at: [http://www.who.int/water\\_sanitation\\_health/hygiene/envsan/phastep/en/](http://www.who.int/water_sanitation_health/hygiene/envsan/phastep/en/)

7. J Waterkeyn & S Cairncross, *Creating demand for sanitation and hygiene through Community Health Clubs: A cost-effective intervention in two districts in Zimbabwe*, Social Science & Medicine 2005, 61, 1958–1970; available online at: <http://www.africaahead.org/wp-content/uploads/2008/01/creating-demand-for-sanitation-and-hygiene-through-chc-cost-effective-in-zimbabwe-waterkeyn-cairncross-2005.pdf>
8. J Waterkeyn *Community Health Clubs in Informal Settlements: A Training Manual for Community Workers using Participatory Activities* City of Cape Town Health Department/Africa AHEAD, South Africa 2007
9. Waterkeyn, J. *District Health Promotion using the Consensus Approach*. WELL/DFID/ LHSTM, UK, 2006
10. J. Waterkeyn, *Hygiene Behaviour Change through the Community Health Club Approach: A cost-effective strategy to achieve the Millennium Development Goals for improved sanitation in Africa* Lambert Academic Publishing, Saarbrücken, 2010.
11. M Sidibe and V Curtis *Hygiene Promotion in Burkina Faso and Zimbabwe: New Approaches to Behaviour Change. Field Note No. 7 in the Blue Gold Series*, Water and Sanitation Program – Africa Region, Nairobi, 2002; available online at: [http://www.wsp.org/UserFiles/file/af\\_bg\\_bf-zm.pdf](http://www.wsp.org/UserFiles/file/af_bg_bf-zm.pdf)
12. K Shordt, M Snel, S Cairncross, A Biran and W Schmidt *Summary of results of the study on the impact and sustainability of WASH in schools research: Kenya and Kerala, 2006–2007* NETWAS Network for Water and Sanitation, Nairobi, Kenya, the London School of Hygiene and Tropical Medicine (LSHTM) and IRC International Water and Sanitation Centre, Delft, the Netherlands, 2008; available online at: <http://www.irc.nl/page/48277>
13. E Bolt, K Shordt, and I Krukkert *School Sanitation and Hygiene Education Results from the assessment of a six-country pilot project* IRC International Water and Sanitation Centre, Delft, the Netherlands, 2006; available online at: <http://www.schoolsanitation.org/Resources/Readings/UNICEF6Country.pdf>
14. M Snel *School Sanitation and Hygiene Education, Thematic Overview Paper* IRC, The Hague, 2003; available online at: <http://www.irc.nl/content/download/4331/51919/file/sshe.pdf>
15. J Devine and C. Kullman *Introductory Guide to Sanitation Marketing* Water and Sanitation Program, 2011; available online at: <http://www.wsp.org/wsp/toolkit/toolkit-home>
16. Rural Water Supply Network *Myths of Rural Water Supply* SKAT Foundation, Switzerland, 2004; available online at: [http://www.rwsn.ch/prarticle.2010-12-10.6328954262/prarticle\\_view](http://www.rwsn.ch/prarticle.2010-12-10.6328954262/prarticle_view)
17. M Mehta, K Virjee, B Evans and K Wathobio *Business Development Services for Community-managed Small Water Enterprises* World Bank WSP-Africa, 2006; available online at: [http://www.wsp.org/wsp/sites/wsp.org/files/publications/625200773125\\_BusinessDevelopmentServicesForCommunityManagedSmallWaterEnterprisesAF.pdf](http://www.wsp.org/wsp/sites/wsp.org/files/publications/625200773125_BusinessDevelopmentServicesForCommunityManagedSmallWaterEnterprisesAF.pdf)
18. *Sanitation 21: Simple Approaches to Complex Sanitation A Draft Framework for Analysis* IWA, UK; available online at: <http://www.iwahq.org/dx/development/technical-expertise/sanitation-21.html>

## Further Reading

D Bradley *Participatory Approaches: A Facilitator's Guide*, VSO, London, 2010; available online at: [www.vso.org.uk](http://www.vso.org.uk)

S Cairncross, K Shordt, S Zacharia and B Govindan *What causes sustainable changes in hygiene behaviour? A cross-sectional study from Kerala, India*. LSHTM, UK and IRC, Netherlands 2003; available online at: <http://www.sciencedirect.com/science?ob=ArticleURL&udi=B6VBF-4G94HY0-6&user=10&rdoc=1&fmt=&orig=search&sort=d&view=c&version=1&urlVersion=0&userid=10&md5=97fa2592819a1fc4ddf039c4bbe2944b>

T Clasen, I Roberts, T Rabie, W Schmidt, S Cairncross *Interventions to improve water quality for preventing diarrhoea. (Cochrane Review. The Cochrane Library, Issue 3, 2006. Oxford; available online at: <http://www.cochrane.org/reviews/en/ab004794.html>*

N Mukherjee, *Participatory learning and action: with 100 field methods. (Studies in rural participation 4). New Delhi, India, 2002*

J Rietbergen-McCracken and D Narayan *Participation and Social Assessment Guidebook on Tools and Techniques* World Bank, Washington DC, 1998; available online at: <http://www-wds.worldbank.org/external/default/main>

M Tapia, A Brasington and L Van Lith *Participation Guide: Involving those directly affected in Health and Development Communication Programmes. HIV/AIDS Alliance. Brighton, 2007; available online at: [http://www.aidsalliance.org/graphics/secretariat/publications/participation\\_guide.pdf](http://www.aidsalliance.org/graphics/secretariat/publications/participation_guide.pdf) Accessed July 2009.*

## Chapter 5: Key Messages

- 1. Designing a water supply, sanitation and hygiene programme is about more than just construction. Community dynamics and socio-economic factors all play a vital role in determining the success or failure of a project or programme.**
- 2. The exact scope of a programme is highly dependent on the local circumstances; the nature of the technical problem to be solved, along with social and economic characteristics of target communities all play a part in determining the optimum intervention.**
- 3. Changing hygiene behaviours is an essential element in achieving health gains in many poor communities. Health is rarely the driver for community decision making however, people are more likely to be motivated by pride or ideas about 'modernity' or beauty to change hygiene practices.**
- 4. Management plans for rural water supply systems have to be designed into the project from the start with appropriate financial arrangements and training to ensure that the system will be kept running.**
- 5. Urban sanitation and water supply present some of the greatest challenges of the coming century and require significant effort and leadership to ensure that service provision at least keeps pace with urbanisation.**

# 6 Economics and Financing

Water supply, sanitation and hygiene are expensive interventions which require careful financial planning. Cost comprises both the initial investment costs and the long term costs of maintenance and operations as well as auxiliary costs such as education, promotion, surveillance, regulation and management. While these costs appear high, the benefits are often significantly higher. The engineer needs to have a basic understanding of how to calculate both costs and benefits so as to be able to promote a project appropriately. Finally, there is the issue of how finances are to be arranged. What sources of funds are available and how will money be collected and dispersed to ensure that there is sufficient cash flow to deliver the project or programme.

## 6.1 What does it cost?

Cost is a critical factor in determining the success of sanitation and water supply projects and programmes. While there is always pressure to keep costs low, it is also important to ensure that adequate levels of service are provided to secure health gains and ensure that the system is properly used and maintained. Trade-offs between capital costs and operational costs and between overall system cost and durability are also often a feature of project planning.

Please click the advert

Is your recruitment website still missing a piece?

Bookboon can optimize your current traffic. By offering our free eBooks in your look and feel, we build a qualitative database of potential candidates.



Contact us to hear more  
[kbm@bookboon.com](mailto:kbm@bookboon.com)










Download free ebooks at [bookboon.com](http://bookboon.com)

Several attempts have been made to assess the costs of reaching the water and sanitation MDG targets but these are generally contentious as they require a number of assumptions to be made – the most important of which relates to what level of service is to be notionally provided. When considering the cost differential between an improved spring and a household water connection to a multi-village scheme for example, or between a simple pit latrine and a networked sewer connection with treatment, these challenges become obvious. In 2004 WHO put together a set of cost estimates based on the best available information at the time and these are yet to be bettered. Table 6.1 shows the indicative capital cost estimates for three regions and a number of different service levels based on the WHO 2004 analysis.

**Table 6.1: Initial investment costs per capita of water and sanitation interventions<sup>(1)</sup>**

	Initial investment cost (US\$ Year 200)		
	Africa	Asia	Latin America and Caribbean
Water improvement			
House connection	102	92	144
Standpost	31	64	41
Borehole	23	17	55
Dug well	21	22	48
Rainwater	49	34	36
Disinfection at point of use	0.13	0.094	0.273
Sanitation improvement			
Sewer connection	120	154	160
Small bore sewer	52	60	112
Septic tank	115	104	160
Pour flush	91	50	60
VIP	57	50	52
Simple pit latrine	39	26	60

Of course the real costs of these facilities and services are considerably higher since the operational and maintenance costs often dwarf the investment costs over the lifetime of the facilities. WHO went on to estimate these (as ranges) for the various technologies they had considered and then to calculate annualised costs for the various types of services (Tables 6.2 and 6.3).

**Table 6.2: Assumptions used in estimated annualised and recurrent costs<sup>[1]</sup>**

	Length of life in years (+range)	Operation and maintenance, surveillance as % of annual costs (+range)	Education as % of annual costs (+range)	Water source protection as % annual cost (+ range)
<b>Water improvement</b>				
House connection	40 (30-50)	30 (30-30)	-	10 (5-15)
Standpost	20 (10-30)	5 (0-10)	-	10 (5-15)
Borehole	20 (10-30)	5 (0-10)	-	5 (0-10)
Dug well	20 (10-30)	5 (0-10)	-	5 (0-10)
Rainwater	20 (10-30)	10 (5-15)	-	0
<b>Sanitation improvement</b>				
Sewer connection	40 (30-50)	120	5 (0-10)	-
Septic tank	30 (20-40)	115	5 (0-10)	-
VIP	20 (10-30)	5 (0-10)	5 (0-10)	-
Simple pit latrine	20 (10-30)	5 (0-10)	5 (0-10)	-

Turning a challenge into a learning curve.  
Just another day at the office for a high performer.

### Accenture Boot Camp – your toughest test yet

Choose Accenture for a career where the variety of opportunities and challenges allows you to make a difference every day. A place where you can develop your potential and grow professionally, working alongside talented colleagues. The only place where you can learn from our unrivalled experience, while helping our global clients achieve high performance. If this is your idea of a typical working day, then Accenture is the place to be.

It all starts at Boot Camp. It's 48 hours that will stimulate your mind and enhance your career prospects. You'll spend time with other students, top Accenture Consultants and special guests. An inspirational two days

packed with intellectual challenges and activities designed to let you discover what it really means to be a high performer in business. We can't tell you everything about Boot Camp, but expect a fast-paced, exhilarating

and intense learning experience. It could be your toughest test yet, which is exactly what will make it your biggest opportunity.

Find out more and apply online.

Visit [accenture.com/bootcamp](http://accenture.com/bootcamp)

• Consulting • Technology • Outsourcing

  
High performance. Delivered.

Please click the advert

**Table 6.3: Annual costs per person reached for water and sanitation improvements<sup>(1)</sup>**

	Annual costs per person reached (US\$ Year 2000)		
	Africa	Asia	Latin America and Caribbean
Water improvement			
Standpost	2.40	4.95	3.17
Borehole	1.70	1.26	4.07
Dug well	1.55	1.63	3.55
Rainwater	3.62	2.51	2.66
Disinfected	0.33	0.26	0.58
Regulated piped water in-house (hardware and software)	12.75	9.95	15.29
Regulated piped water in-house (software only)	8.34	5.97	9.06
Sanitation improvement			
Septic tank	9.75	9.10	12.39
VIP	6.21	5.70	5.84
Small pit latrine	4.88	3.92	6.44
Household sewer connection plus partial treatment of sewage (hardware and software)	10.03	11.95	13.38
Household sewer connection plus partial treatment of sewage (software only)	4.84	5.28	6.46

We have already seen however (**Figure 3.12**) that such generalised estimates need to be treated with caution. They do little more than give an indication, but detailed cost estimates are required in every specific case for planning purposes. Such detailed cost estimates need to include careful assessment of the long term operation and maintenance costs as well as the management and establishment costs required to support a programme. Even very simple low-cost interventions such as CLTS often carry significant operational and management overhead. Table 6.4 shows some estimates of costs for CLTS from a 2008 study of three WaterAid country programmes.



**Table 6.4: Costs of CLTS interventions in five programme scenarios (2008 USD) <sup>[2]</sup>**

	Bangladesh		Nepal		Nigeria
	VERC	UST	Hills	Tarai	
Per household	7	6	58	84	30
Per latrine	12	42	61	126	71
Per latrine in use	n/a	n/a	108	122	77

## 6.2. The Economics of Sanitation and Water Supply

Economic benefits from water supply, sanitation and hygiene can be very high indeed. A global assessment of the benefits of sanitation alone estimated that the return on a \$1 investment in sanitation could be as high as \$9 globally <sup>[1]</sup>. A global initiative to calculate the losses associated with poor sanitation in countries around the world concluded for example that in South Asian countries losses are equivalent to some 4.5 to 6.5% of GDP. India loses just under US\$54 billion per year due to the negative impacts of poor sanitation, mostly due to the costs associated with ill-health <sup>[3]</sup>.

These large numbers are useful for advocacy at the national level. However at the level of the project or programme how can benefits for sanitation and water supply be estimated?

Benefits can in general be divided into health-related benefits and non-health related benefits. The health related benefits (i.e., the economic advantages to people not getting sick) can broadly be defined as<sup>[4]</sup>:

- Health care savings (health agencies);
- Health care savings (individuals);
- Productivity gains (working days);
- Productivity gains (school days);
- Healthy days gained (pre-school children);
- Time savings (convenience of supply); and
- Value of deaths averted.

The non-health gains from improved water and sanitation include positive impacts on gender (particularly related to the empowerment of women and girls), education, disability and environmental protection. However, a recent literature review did note that there is limited research to quantify these benefits <sup>[5]</sup>.

In general benefits from health gains are the easiest to estimate, but even here there are difficulties. Economic gains from better health are usually largely related to an increase in productive days for economically active members of the household and school children. Calculating the value of these benefits is challenging however and requires both solid baseline information on health status (so as to be able to assess or predict marginal health gains) and information on the economic value of the time gained. Use of the DALY methodology (see Box 2.1) can facilitate an assessment of the value of both reduced sickness and deaths averted. Self reporting on illness is notoriously unreliable, so data from health posts and other surveillance mechanisms may be preferable. However this data is only useful if it is clear that the majority of sick people present themselves to the medical centre for treatment; this is far from likely in many poor and informal communities. If health data are available these can be converted to an economic value using the opportunity cost of labour for productive members of the household. If this proves difficult it is sometimes sufficient to assess likely impacts on diarrhoea incidence of different options for an intervention and then examine their cost effectiveness.

For more details on the methods that can be used to assess economic benefits, readers are referred to the Economics of Sanitation Initiative of the Water and Sanitation Program of the World Bank <sup>[6]</sup> and to the WHO Water and Health Economics team <sup>[7]</sup>.

### 6.3 Financial Assessments

The ratio of benefits to costs is important for overall planning purposes but often managers are more interested in the financial benefits of an intervention. This may be particularly important in urban areas where utility service providers (public or private) need to assess whether their income from user payments will be adequate to cover the costs of providing services.

A simple calculation can be made which compares the cost and income stream associated with an intervention over the lifecycle of the project. Spreadsheet-based calculations are ideally suited for this purpose. Expenses and income in the future are discounted, to reflect the fact that their value at today's prices is lower than expenditures incurred in the present. The usual approach is to set up a spreadsheet with three rows and one column for each year of the project lifecycle. In the first row expenses are entered (so capital costs will appear in year one, and an annual maintenance cost in each subsequent year). Projected income from users is entered in the second row (possibly rising if additional users are likely to join the project over time). The net income (income minus expenditure) is calculated for each year in the third row. These net income values can then be discounted using the prevailing discount rate (usually the long-term interest rate associated with Bank investments) to give their net present value (NPV) in today's money. Most spreadsheets will then calculate the net present value of the overall project summing the NPV for each year. A positive value means that the project is financially viable – the operator could borrow sufficient funds to invest in the capital, and this could be repaid through user fees over the lifecycle of the project.

These simple calculations are important as they indicate whether a project is likely to be financially sustainable or not. However, in many cases governments are unwilling or unable to charge users the real costs of delivering the service. This is a particular problem with sanitation. When this happens, public subsidies are required to fill the shortfall.

### 6.4 Subsidies

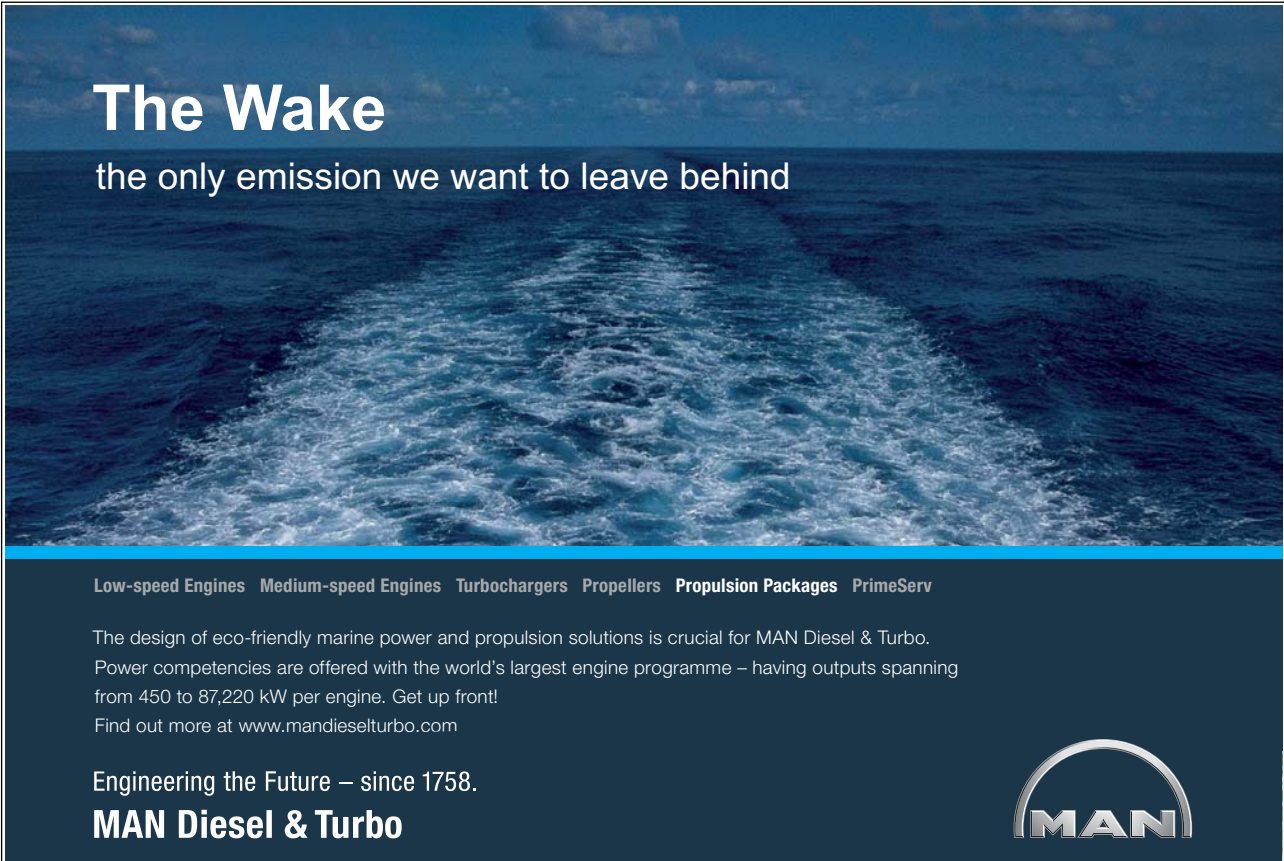
In a water, sanitation and hygiene programme several things require financing. From Chapter 5 we can broadly define

these as:

- **Supporting and Developing an Enabling environment:** These could include expenditures linked to policy development, capacity building, knowledge sharing or coordination. However, it may be difficult to estimate those costs other than by taking a percentage of overhead costs for staff working on policy development at sector level, either within the Government or within donors.
- **Hygiene behaviour change activities:** This would include hygiene education and mobilisation activities in schools, communities and households, social marketing for handwashing with soap, interventions in the design of school curricula and teacher training etc.
- **Sanitation marketing costs:** market assessments, demand promotion, costs of community-led total sanitation activities, interventions to stimulate supply of appropriate goods and services (e.g. training or financial support to private providers) etc.
- **Community development activities:** usually to build capacity for community management if required;
- **Cost of public infrastructure and services** (capital and operational costs) of for example schools, public toilets, shared network services; and
- **Cost of private infrastructure and services** (capital and operational costs) of household sanitation<sup>[8]</sup>.

Funding for these comes ultimately from only two sources – public funds from government and contributions from users. The government may have access to grant or subsidised loan funding from international agencies and NGOs but these will in general have to be repaid through general taxation. Private investors may make capital funds available but these would be expected to be recovered through user-fees.

Please click the advert




**The Wake**  
the only emission we want to leave behind

Low-speed Engines Medium-speed Engines Turbochargers Propellers Propulsion Packages PrimeServ

The design of eco-friendly marine power and propulsion solutions is crucial for MAN Diesel & Turbo. Power competencies are offered with the world's largest engine programme – having outputs spanning from 450 to 87,220 kW per engine. Get up front!  
Find out more at [www.mandieselturbo.com](http://www.mandieselturbo.com)

Engineering the Future – since 1758.  
**MAN Diesel & Turbo**



Governments may choose to channel public funds into water and sanitation. There are several ways in which this can be done. Some of the most popular are discussed briefly below. A summary of financing options for sanitation in particular is shown in Table 6.5.

#### *Subsidised connection fees for urban water supplies and sewerage*

One of the major barriers to accessing water supply for poor households in urban areas is the high and often very uncertain costs of a new connection. It is too difficult, often to the point of being impossible, for poor households to pay the upfront fee of USD 100 or more which is commonly charged. The Asian Development Bank has this to say:<sup>[9]</sup>

“High and upfront water connection charges often act as a major barrier to connecting the poor. So why charge for a connection? Mobile companies provide free phones to attract subscribers. Supermarkets do not charge entrance fees to potential shoppers. Why can this not be applied to water services?”

In fact connection fees are not necessary: the water-supply agency can either slightly increase the water tariff to cover connection fees, or it can recover the connection fee by a surcharge on the monthly water bill over period of, say, five years. Thus there is no need at all to ‘charge to enter the water shop.’<sup>[10]</sup> Reducing or removing connection fees is one of the single most progressive thing that a water utility or city authority can do to increase access for the poorest. In most cities, where it is the poorest who are most likely not to have a water connection, it can be one of the most effective redistributive measures available.

#### *Cross subsidies on consumption of urban water*

By contrast another popular type of subsidy is less progressive. Many operators employ what is known as an Increasing Block Tariff (IBT). IBTs:

“provide two or more prices for water used, where each price applies to a customer’s use with a defined block. Prices within IBTs rise with each successive block. Some tariff structures have as many as ten blocks, each with a different price. The common characteristic of IBTs, as they are applied in developing countries, is that the first block price is deliberately set below cost, however cost may be defined.”<sup>[11]</sup>

One of the best known IBTs in the world is used in South Africa, where the first 6 m<sup>3</sup> of water (representing a lifeline consumption for a typical household) is provided free of charge to every household. Any consumption over the 6m<sup>3</sup> - threshold is charged at an above-cost rate. The idea of an IBT is that poorer households can benefit from lower-cost water because they consume less. This argument may well hold true in South Africa where the lowest block has been kept low (at 6m<sup>3</sup> per household per month).

However IBTs are known to have problems which make them a less-than-ideal option in many cases. In the first case, IBTs are based on the assumption that poor households consume less. This argument falls down if poor households cluster together to share a connection or where poor households are dependent on richer neighbours from whom they purchase water. In these cases the poor are likely to pay at the higher rate because their collective consumption is higher. Secondly IBTs guarantee that all consumers, rich and poor, benefit from the subsidy since everyone consumes within the first block – this means that funds which could be used to support poor consumers are used for everyone. Political pressures in many places ensure that the first block is significantly large and that the majority of households consumer water only within the subsidised band. Finally IBTs make it difficult for operators to predict or manage demand and do nothing to promote water conservation in the lowest price band.

Although it may not seem to be the case, uniform tariffs based on metered consumption are often significantly more pro-poor than IBTs. <sup>[11]</sup> One form of cross-subsidy however is useful in some cases – that is a cross subsidy between commercial and domestic consumers.

Please click the advert

**Brain power**

By 2020, wind could provide one-tenth of our planet's electricity needs. Already today, SKF's innovative know-how is crucial to running a large proportion of the world's wind turbines.

Up to 25 % of the generating costs relate to maintenance. These can be reduced dramatically thanks to our systems for on-line condition monitoring and automatic lubrication. We help make it more economical to create cleaner, cheaper energy out of thin air.

By sharing our experience, expertise, and creativity, industries can boost performance beyond expectations. Therefore we need the best employees who can meet this challenge!

**The Power of Knowledge Engineering**

Plug into The Power of Knowledge Engineering.  
Visit us at [www.skf.com/knowledge](http://www.skf.com/knowledge)

**SKF**

*Subsidised Toilets*

Another popular form of subsidy is the provision of free or very cheap toilets. While these can appear to be very pro-poor, care is needed in the design of subsidy programmes to ensure that they do not distort the provision of sanitation in unexpected ways. Some subsidy programmes tend to suppress technical innovations, resulting in overly-costly designs for which contractors know they are guaranteed payment. Quality may also suffer where government rather than the affected householders are responsible for overseeing construction. Subsidised latrines also suppress demand from communities (an effect which has been widely noted by practitioners of Community-led Total Sanitation). Nonetheless some better-designed subsidy programmes do seem to have been relatively successful. In general those which leave control and decision making in the hands of householders themselves seem to be the most effective. These can generally be divided into two types – subsidies directed at service providers to enable them to offer sanitation facilities and services for sale more cheaply, and subsidies delivered in the form of cheap credit, to enable householders to borrow money at affordable rates to invest in sanitation.<sup>[xxx]</sup>

**Table 6.5: Options for delivery of public subsidies**

	How it works		Who benefits?	Advantages	Disadvantages
	Urban	Rural			


<b>Connection subsidies</b>		Cost of connecting is covered by a transfer from govt to utility, through vouchers or by transfer from general utility revenue	Unconnected households (particularly the poor) living in areas covered by water supply or sanitation.	Very effective at reaching the poorest (who tend to be unconnected) and increases connectivity to the system which improves operational efficiency. Ensures public benefits from urban systems.	No disbenefits but only relevant where households can connect to operational network.
<b>Cross subsidies</b>	Transfers through the tariff from high- to low-consumers or from connected to unconnected households	Transfers (in cash and labour) from richer to poorer households to construct latrines or through the tariff from high- to low consumers	Varies with type of subsidy.	In rural areas community may be efficient at targeting and allocating resources. Can also be used for O&M / upgrading in urban areas	In urban areas targeting may be poor and system may fail if utility finances are weak. In rural areas can be captured by elites.
<b>Infrastructure subsidies (private facilities)</b>	Public sector provision of latrines or latrine parts, usually through direct implementation with some input (cash/ labour) from households		Household/ individuals who receive the subsidized latrine. Theoretically community through demonstration effects.	If well targeted enables poorest households to access services.	Expensive, with limited reach. Tends to skew/ fix technical designs at 'high-cost' end and stifles market/ self provision and innovation. Open to perverse incentives. Does not take into account O&M
<b>Infrastructure subsidies (public facilities)</b>	Public sector provision of shared elements of the sanitation system.		Households connected to a working system.	Ensures public benefits from urban systems.	Does little to benefit those who are unconnected. May divert resources from getting existing system to work. Does not take into account O&M

<b>Operational subsidies (software services)</b>	Staff and operational costs of health and water extension workers.		Communities who fall within operational area of govt. department	Allows public funds to be used to stimulate demand without skewing the supply-side market.	Difficult to track and quantify. Accountability usually low.
<b>Operational subsidies (utility/small operators)</b>	Opex subsidies to utilities and local government service providers		Connected households.	Addresses long term O&M	May damage long term sustainability of utility operations by building in inefficiencies and low-tariff/poor service equilibrium.
<b>Consumption subsidies</b>	Subsidies through reduced tariff or deferred maintenance	Rarely relevant.	Connected households only.	Cheap to administer and can theoretically be targeted through increasing-block tariffs or other disaggregated consumption tariffs. Requires operational subsidies.	May damage financial status of utility further, maintenance backlog increases risk and reduces capacity to connect new households.
<b>Direct subsidies</b>	Payment direct to individuals or households. Payment may be in the form of cash, voucher or tax credit. Householder or individual spends the money either freely or on specified goods and services		Household/ individual can access services. Where supply is not constrained specific suppliers may also increase market share.	Empowers the household/ individual and stimulates the supply of goods and services without constraining the market	Expensive and complex to administer – probably not viable accept when bundled together with other social services when targeting becomes cost-effective. Does not take into account longer term O&M



<b>Output-based subsidies</b>	Subsidies paid only after delivery of a service (working latrines being used, open-defecation-free communities, delivery and treatment of faecal sludge at a wastewater treatment plant)	Target households – payment is only made if they receive a service so accountability is high.	Prevents wastage of public money paying for inputs that do not result in desirable outcomes. Encourages efficiency and accountability.	Complex to administer and investments must be pre-financed.
<b>Subsidised credit</b>	Interest payments on micro-finance services are kept low by provision of bank guarantees or other support to micro finance providers if they lend for sanitation goods and services.	Households whose primary barrier to access is financial	Does not distort the market for goods and services and stimulates micro finance interest in sanitation. Households retain control.	Requires competent micro finance providers, can be complex to administer and requires good financial skills.

Please click the advert



THIS **ebook** IS PRODUCED WITH **iText®**

Download free ebooks at [bookboon.com](http://bookboon.com)

## References

1. G Hutton and L Haller *Evaluation of the Costs and Benefits of Water And Sanitation Improvements at the Global Level* WHO, Geneva, 2004; available online at: [http://www.who.int/water\\_sanitation\\_health/wsh0404.pdf](http://www.who.int/water_sanitation_health/wsh0404.pdf)
2. B Evans, J Colin, H Jones, and A Robinson *Sustainability and equity aspectsof total sanitation programmes - A study of recent WaterAid-supported programmes in three countries: global synthesis report*, WaterAid, London, 2009; available online at <http://www.personal.leeds.ac.uk/~cenbee/Publications/Global%20sythesis%20report.pdf>
3. Water and Sanitation Program (WSP) *Economics of Sanitation Initiative* full range of countries studies available online at: <http://www.wsp.org/wsp/node/101>
4. A Prüss-Üsten, R Boss, F Gore, J Bartam *Safer Water, Better Health; Costs, Benefits and Sustainibility of Interventions to Protect and Promote Health*, WHO ISBN 978 92 4 159643 5, 2008; available online at: [http://www.who.int/quantifying\\_ehimpacts/publications/saferwater/en/index.html](http://www.who.int/quantifying_ehimpacts/publications/saferwater/en/index.html)
5. J Pearson, and K. McPhedran *The Case for Sanitation; A Literature Review of the Non-health and Socail Impacts of Sanitation* London School of Hygiene and Tropical Medicine 2007
6. <http://www.wsp.org/wsp/sites/wsp.org/files/publications/WSP-ESI-Flier.pdf>
7. [http://www.who.int/water\\_sanitation\\_health/economic/en/](http://www.who.int/water_sanitation_health/economic/en/)
8. B Evans,C van der Voorden, and A Peal *Public Funding for Sanitation: The Many Faces of Sanitation Subsidies*, Water Supply and Sanitation Collaborative Council, Geneva, Switzerland, 2009 available online at: [http://www.personal.leeds.ac.uk/~cenbee/Publications/Public\\_Funding\\_for\\_Sanitation\\_the\\_many\\_faces\\_of\\_sanitation\\_subsidies.pdf](http://www.personal.leeds.ac.uk/~cenbee/Publications/Public_Funding_for_Sanitation_the_many_faces_of_sanitation_subsidies.pdf)
9. R Frauendorfer, *The Hows and Whys of Water Connection Charges*, Asian Development Bank, Manila, 2008; available online at: <http://www.adb.org/Water/Knowledge-Center/connection-charges/default.asp>.
10. RWA Franceys, Charging to enter the water shop? The costs of urban water connections for the poor, *Water Science and Technology: Water Supply* 2005, 5 (6), 209–216; abstract available online at: <http://www.iwaponline.com/ws/00506/ws005060209.htm>.
11. J Boland and D Whittington *The Political Economy of Increasing Block Tariffs in Developing Countries*; available online at: <http://www.eepsea.org/uploads/user-S/10536141760ACF33E.pdf>
12. S Trémolet, P Kolsky and E Perez (2010) *Financing On-site Sanitation* World Bank, Washington DC; available online at: <http://www.tremolet.com/publications/financing-site-sanitation-poor>

## Further Reading

**Foster, V., Gomez-Lobo, A., Halpern, J. (2000).** Designing Direct Subsidies for the Poor—A Water and Sanitation Case Study. Note No.211. Public Policy for the Private Sector. The World Bank, Washington D.C., USA.

**Foster, V. (2001).** Lower costs with higher benefits – Water and Sewerage Services for Low Income Communities. WSP – Andean Region, Lima, Peru. [http://www.latinosan2007.net/conferencia.perusan/PDFs/biblioteca/Tema2/nota\\_ing\\_tema2.pdf](http://www.latinosan2007.net/conferencia.perusan/PDFs/biblioteca/Tema2/nota_ing_tema2.pdf)

**Foster, V. and Pattanayak, S. and Stalker-Prokopy, L. (2002).** Distributional Incidence of Current and Potential Water tariffs and Subsidies in Bangalore, India and Kathmandu, Nepal..WSP World Bank, Washington DC, USA.

**Mehta, M. (2003).** Meeting the Financing Challenge for Water Supply and Sanitation. WSP, World Bank, Washington D.C., USA.

**Mehta, M. and Knapp, A. (2004).** The challenge of financing sanitation for meeting the Millennium Development Goals. WSP-Africa, Nairobi, Kenya. [http://www.sulabhervis.in/admin/upload/pdf\\_upload/af\\_finsan\\_mdg.pdf](http://www.sulabhervis.in/admin/upload/pdf_upload/af_finsan_mdg.pdf)

Lenton, R., Wright, A. M. and Lewis, K. (2005). Health, dignity and development: what will it take? United Nations Millennium Project. Task Force on Water and Sanitation. Earthscan, London, UK. <http://www.unmillenniumproject.org/reports/reports2.htm#07>

**Jenkins, M. and Sugden, S. (2006).** Rethinking Sanitation: Lessons and Innovation for Sustainability and Success in the New Millennium. Human Development Report Office. Occasional Paper for the Human Development Report 2006 (2006/27). UNDP and LSHTM, London, UK. <http://hdr.undp.org/en/reports/global/hdr2006/papers/jenkins%20and%20sugden.pdf>

**Schuen, R. and Parkinson, J. (forthcoming).** Study for Economic Analysis of Ecological Sanitation in Sub-Saharan Africa. WSP, Hydrophil and Atkins. Vienna, Austria.

### Chapter 6: Key Messages

1. **Water supply and sanitation are expensive. Calculating the full costs of systems and services is a critical part of project planning. The full costs include capital and operational costs as well as programming and support costs.**
2. **The benefits of investing in sanitation and water supply are very large. A global study estimated that for sanitation alone, an investment of \$1 yields an average economic return of \$9.**
3. **Both the economic and financial returns on investments in water supply and sanitation need to be calculated when preparing a project or programme. Economic returns are important in determining the extent to which public investments (government funding and international development aid expenditure) can be justified. Financial returns are important in determining how a project is to be financed, and whether it is financially sustainable and therefore viable.**
4. **Public subsidies are often justified because of the huge public health benefits of water supply and sanitation but they need to be designed with care.**

# Annex A

## Design of On-Site Sanitation Systems

This Annex details the design calculations required to determine the pit volumes for single-pit VIP latrines and single-pit pour-flush latrines, and for each of the two pits of alternating twin-pit pour-flush latrines, and the vault volumes for each of the two vaults of eThekwini latrines.

### A.1 Single-pit VIP latrines

VIP-latrine pits are designed for the storage of digested faecal solids, as follows:

$$\text{Effective pit volume (m}^3\text{)} = rPN$$

where  $r$  is the digested solids accumulation rate (m<sup>3</sup> per person per year),  $P$  the number of people using the latrine (i.e., the household size), and  $N$  the effective life of the latrine (years).

Typically  $r = 0.05$  m<sup>3</sup> per person per year in 'dry' pits (i.e., the pit base is above the groundwater table at all times of the year) and 0.03 m<sup>3</sup> per person per year in 'wet' pits (i.e., the pit base is below the groundwater table either permanently

Please click the advert



360°  
thinking.

**Deloitte.**

Discover the truth at [www.deloitte.ca/careers](http://www.deloitte.ca/careers)

© Deloitte & Touche LLP and affiliated entities.

Download free ebooks at [bookboon.com](http://bookboon.com)

or seasonally) – if bulky anal cleansing materials (e.g., corn cobs, leaves, mud balls, stones) are used, these values are increased by 50%; and  $N$  is normally taken as 10 years.

The effective depth of the pit ( $H$ , m) is determined from the effective volume ( $V$ , m<sup>3</sup>) and its cross-sectional area. If  $D$  (m) is the pit diameter, then:

$$H = \frac{V}{\pi D^2/4}$$

The total pit depth is ( $H + 0.5$ ) m – i.e., there is 0.5-m freespace at the top of the pit.

## A.2 eThekwini latrines

eThekwini latrines are alternating twin-vault latrines. The effective volume of each vault is  $rPN$ , as in section A.1, but with  $r = 0.1$  m<sup>3</sup> per person per year (this value is higher than that used in section A.1 as the vault contents are kept dry by the urine diversion, so solids digestion is much slower) and  $N = 1$  year.

The eThekwini latrines in KwaZulu-Natal, South Africa have rectangular vaults, each 1210 mm × 1310 mm, with an overall height of 800 mm. Thus the volume of each vault is 1.27 m<sup>3</sup>. Assuming that the corresponding effective vault volume is 0.8 m<sup>3</sup>, the number of people ( $P$ ) that can use a vault of this size is given by:

$$P = \frac{\text{Effective vault volume (m}^3\text{)}}{rN} = \frac{0.8}{0.1 \times 1} = 8$$

which is the average household size in eThekwini.

## A.3 Single-pit pour-flush latrines

The pits for single-pit pour-flush latrines are designed both for solids storage (as in section A.1) and for the infiltration of the latrine flush-water.

The pit-sidewall area required for infiltration (the ‘infiltrative area’,  $A_i$  m<sup>2</sup>) is given by:

$$A_i = \frac{\text{Wastewater flow (litres/day)}}{\text{Long - term infiltration rate (litres/m}^2\text{ day)}}$$

The wastewater (urine + flush water) flow is normally around 10–20 litres per person per day, and the long-term infiltration rate depends on the soil type, as follows:

- Sand: 50 l/m<sup>2</sup> d
- Sandy loams: 30 l/m<sup>2</sup> d
- Porous silty and silty clay loams: 20 l/m<sup>2</sup> d
- Compact silty and silty-clay loams, and clays (but not expansive clays): 10 l/m<sup>2</sup> d

For circular pits of diameter  $D$  (m), the effective depth for infiltration ( $H_i$ , m) is given by:

$$H_i = \frac{A_s}{\pi D}$$

The total depth of the pit is the sum of the effective depths for solids storage (as determined in section A.1) and for infiltration, plus 0.5 m freespace. This design ensures that there is still sufficient infiltrative area available when the pit has nearly reached its design solids-storage capacity.

#### A.4 Alternating twin-pit pour-flush latrines

The total depth of each pit is either the effective depth for solids storage (section A.1) or the effective depth for infiltration (section A.3), whichever is the larger, plus 0.5-m freespace. This design is possible because the infiltrative capacity of the sidewall is restored while each pit is not in use.

# Annex B

## Hydraulic Design of Simplified Sewers

Simplified sewerage is designed very rigorously. In this Annex the design is detailed first by considering the properties of a circular section (the small-diameter sewers used in simplified sewerage are circular in cross section), then by showing how to determine the minimum sewer gradient (which ensures self-cleansing of the sewer), the sewer diameter, and whether hydrogen sulphide is likely to be a problem in the sewer or not.

### B.1 Notation

The following notation is used for the hydraulic design of simplified sewerage – note that some parameters are used with two units (for example, the sewer diameter is calculated in m but quoted in mm, and the flow is in either m<sup>3</sup>/sec or litres/sec); special care must be taken to avoid any confusion with units and thus gross errors in the design calculations.

Please click the advert



MSM

MAASTRICHT SCHOOL OF MANAGEMENT

Increase your impact with MSM Executive Education



For almost 60 years Maastricht School of Management has been enhancing the management capacity of professionals and organizations around the world through state-of-the-art management education.

Our broad range of Open Enrollment Executive Programs offers you a unique interactive, stimulating and multicultural learning experience.

**Be prepared for tomorrow's management challenges and apply today.**

For more information, visit [www.msm.nl](http://www.msm.nl) or contact us at +31 43 38 70 808 or via [admissions@msm.nl](mailto:admissions@msm.nl)

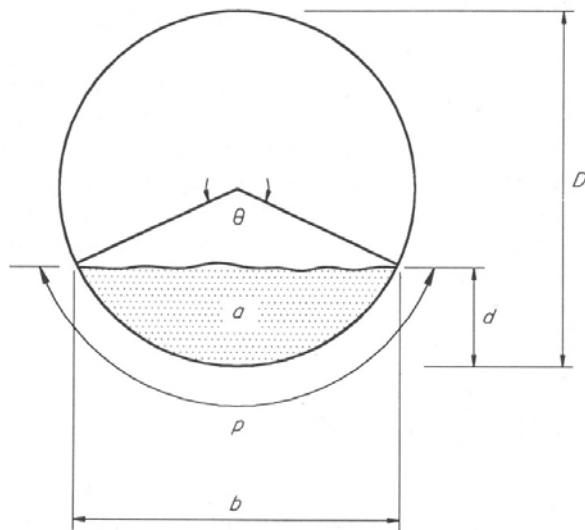
the globally networked management school

<i>Symbol</i>	<i>Parameter</i>
$a$	Area of flow at depth of flow $d$ , m <sup>2</sup>
$d$	Depth of flow, m
$D$	Sewer diameter, m or mm
$g$	Acceleration due to gravity, m/s <sup>2</sup> (= 9.81 m/s <sup>2</sup> )
$i$	Sewer gradient, m/m
$I_{\min}$	Minimum sewer gradient, m/m
$k_a$	Area proportionality factor [= $a/(\pi D^2/4)$ ]
$k_r$	Hydraulic radius proportionality factor [= $r/(D/4)$ ]
$k_1$	Peak flow factor (= peak wastewater flow/mean daily wastewater flow; usual design value: 1.8)
$k_2$	Return factor (= wastewater flow/water consumption; usual design value: 0.85)
$l$	Length of sewer section, m
$n$	Gauckler-Manning roughness coefficient (usual value: 0.013)
$p$	Wetted-flow perimeter at depth of flow $d$ , m
$P$	Contributing population
$q$	Peak wastewater flow, m <sup>3</sup> /s or l/s
$r$	Hydraulic radius, m (= $a/p$ )
$v$	Velocity of wastewater flow, m/s
$w$	Water consumption, litres/person day
$W$	Weight of wastewater, N
$\theta$	Angle of flow, <u>radians</u>
$\rho$	Density of wastewater, kg/m <sup>3</sup>
$\tau$	Tractive tension, N/m <sup>2</sup> (Pa)
$\phi$	Angle of inclination of sewer to horizontal ( $\tan\phi = i$ )

## B.2 Properties of a circular section

The flow in simplified sewers is always open channel flow – that is to say, there is always some free space above the flow of wastewater in the sewer. The hydraulic design of simplified sewers requires knowledge of the area of flow ( $a$ ) and the hydraulic radius ( $r = a/p$ , the area of flow divided by the wetted perimeter). Both these parameters vary with the depth of flow, as shown in Figure B1.





**Figure B1:** Definition of parameters for open channel flow in a circular sewer.

From this figure, trigonometric relationships can be derived for the following parameters:

- the area of flow ( $a$ ),  $m^2$ ,
- the wetted perimeter ( $p$ ),  $m$ ,
- the hydraulic radius ( $r = a/p$ ),  $m$ , and
- the breadth of flow ( $b$ ),  $m$ .

These parameters depend on the following three parameters:

- the angle of flow ( $\theta$ ), radians,
- the depth of flow ( $d$ ),  $m$ , and
- the sewer diameter ( $D$ ),  $m$ .

The ratio  $d/D$  is termed the 'proportional depth of flow'. In simplified sewerage the permissible range of  $d/D$  is 0.2–0.8 – i.e.,  $d$  cannot be  $<0.2D$ , nor  $>0.8D$ .

Elementary trigonometry gives the following relationships:

- Angle of flow:
  - $\theta = 2\cos^{-1}[1 - 2(d/D)]$
- Area of flow:
  - $a = D^2[(\theta - \sin\theta)/8]$

- Wetted perimeter:
  - $p = \theta D/2$
  
- Hydraulic radius:
  - $r = a/p = [D/4][1 - ((\sin\theta)/\theta)]$
  
- Breadth of flow:
  - $b = \sin(\theta/2)$

The following equations for  $a$  and  $r$  are used:

$$a = k_a D^2 \text{ and } r = k_r D$$

where  $k_a = \frac{1}{8}(\theta - \sin\theta)$  and  $k_r = \frac{1}{4}[1 - (\sin\theta)/\theta]$ .

Table B1 gives the values of  $k_a$  and  $k_r$  for  $0.2 < d/D < 0.8$ .

Please click the advert

**See the light!**  
**The sooner you realize we are right,  
 the sooner your life will get better!**

A bit over the top? Yes we know!  
 We are just that sure that we can make your  
 media activities more effective.



Get "Bookboon's Free Media Advice"  
 Email [kbm@bookboon.com](mailto:kbm@bookboon.com)















Table B1. Values of  $k_a$  and  $k_r$  for  $0.2 < d/D < 0.8$ .

$d/D$	$k_a$	$k_r$
0.20	0.1118	0.1206
0.22	0.1281	0.1312
0.24	0.1449	0.1416
0.26	0.1623	0.1516
0.28	0.1800	0.1614
0.30	0.1982	0.1709
0.32	0.2167	0.1802
0.34	0.2355	0.1891
0.36	0.2546	0.1978
0.38	0.2739	0.2062
0.40	0.2934	0.2142
0.42	0.3130	0.2220
0.44	0.3328	0.2295
0.46	0.3527	0.2366
0.48	0.3727	0.2435
0.50	0.3927	0.2500
0.52	0.4127	0.2562
0.54	0.4327	0.2621
0.56	0.4526	0.2676
0.58	0.4724	0.2728
0.60	0.4920	0.2776
0.62	0.5115	0.2821
0.64	0.5308	0.2862
0.66	0.5499	0.2900
0.68	0.5687	0.2933
0.70	0.5872	0.2962
0.72	0.6054	0.2987
0.74	0.6231	0.3008
0.76	0.6405	0.3024
0.78	0.6573	0.3036
0.80	0.6736	0.3042

### B.3 Design procedure

The whole length of the sewer is divided into shorter sections over which the hydraulic gradient is reasonably uniform, and the minimum sewer gradient and the sewer diameter have to be determined for each section of the sewer.

The minimum sewer gradient is based on the peak wastewater flow at the beginning of the design period ( $q_i$ ), and sewer diameter is based on the peak wastewater flow at the end of the design period ( $q_f$ ) – the reasons for this is that the sewer cannot become blocked at the start and it must be able to convey the wastewater flow at the end.

The flows are based on the number of people (the ‘contributing population’) connected to the section of sewer being designed above its downstream end – i.e., the number of people discharging their wastewater into this section of sewer, including the upstream population whose wastewater enters the section at its upstream end.

#### B.3.1. Minimum sewer gradient

The peak daily wastewater flow (litres/sec) is estimated from the contributing population’s water consumption:

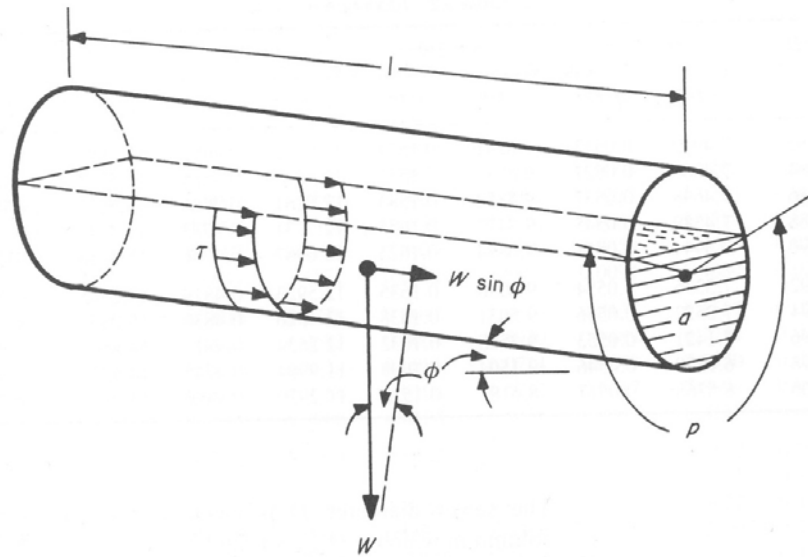
$$q_i = k_1 k_2 Pw / 86,400$$

where 86,400 is the number of seconds in a day.

The design values used in Brazil for  $k_1$  and  $k_2$  are 1.8 and 0.85, respectively.<sup>[1]</sup> So this equation becomes:

$$q_i = 1.8 \times 10^{-5} Pw$$

The sewer is designed to achieve a specified minimum tractive tension at peak flow to ensure that the sewer is ‘self-cleansing’ – i.e., does not become blocked.<sup>[1,2]</sup> Tractive tension is the force per unit wetted area of the sewer exerted by the component of the wastewater weight per unit sewer length along the axis of wastewater flow (Figure B2); its units are N/m<sup>2</sup> (i.e., Pascals, Pa).



**Figure B2:** Definition of parameters for tractive tension in a circular sewer.

Please click the advert

**I WANT TO CHANGE DIRECTION,  
AND THE WORLD.**

[GOT-THE-ENERGY-TO-LEAD.COM](http://GOT-THE-ENERGY-TO-LEAD.COM)

We believe that energy suppliers should be renewable, too. We are therefore looking for enthusiastic new colleagues with plenty of ideas who want to join RWE in changing the world. Visit us online to find out what we are offering and how we are working together to ensure the energy of the future.

**RWE**  
The energy to lead

Thus, from Figure B2:

$$\tau = W \sin \phi / pl = (\rho g a l) \sin \phi / pl$$

Since  $a/p =$  the hydraulic radius,  $r$ :

$$\tau = (\rho g r) \sin \phi$$

When  $\phi$  is small,  $\sin \phi = \tan \phi$ , and  $\tan \phi =$  the sewer gradient,  $i$ . Thus:

$$\tau = \rho g r i$$

Since  $r = k_r D$ , this equation can be written as:

$$D = (\tau / \rho g) / k_r i$$

The flow  $q_i$  can also be derived from the Gauckler-Manning equation for the velocity of flow:<sup>[3-5]</sup>

$$v = (1/n) r^{2/3} i^{1/2}$$

Since  $q_i = av$ :

$$q_i = (1/n) a r^{2/3} i^{1/2}$$

Writing  $r$  as  $k_r D$ ,  $a$  as  $k_a D^2$  and  $D$  as  $(\tau / \rho g) / k_r i$ :

$$q_i = (1/n) k_a (k_r)^{-2} (\tau / \rho g)^{8/3} i^{-13/6}$$

This equation is known as the Gauckler-Manning flow equation. It can be rearranged, with  $i = I_{\min}$  and  $\tau = \tau_{\min}$ , to give:

$$I_{\min} = [(1/n) k_a (k_r)^{-2}]^{6/13} [\tau_{\min} / \rho g]^{16/13} q_i^{-6/13}$$

With  $n = 0.013$ ,  $\rho = 1000 \text{ kg/m}^3$ ,  $g = 9.81 \text{ m/s}^2$ , and with  $k_a = 0.1118$  and  $k_r = 0.1206$  (these are the values for  $d/D = 0.2$ , the minimum value used in simplified sewerage), this equation becomes:

$$I_{\min} = 2.33 \times 10^{-4} (\tau_{\min})^{16/13} q_i^{-6/13}$$

The design value of  $\tau_{\min}$  is 1 Pa.<sup>[4]</sup> Therefore:

$$I_{\min} = 2.33 \times 10^{-4} q_i^{-6/13}$$

In this equation the units of  $q_i$  are m<sup>3</sup>/s.

For  $q_i$  in litres/sec:

$$I_{\min} = 5.64 \times 10^{-3} q_i^{-6/13}$$

So the minimum sewer gradient depends only on the peak wastewater flow.

A very important concept for the design of simplified sewerage is the use of a minimum peak flow of 1.5 litres/sec. This value, which is approximately the peak flow resulting from flushing a toilet, must be used if the value calculated for  $q_i$  is less than this minimum value.

► For  $q_i = 1.5$  l/s,  $I_{\min}$  is given by the last equation as 0.00468 (or 4.68‰) – i.e., 1 in 214, which is generally rounded to 1 in 200 (5‰); a gradient of 1 in  $x$  means that the fall over a horizontal distance of  $x$  m is 1 m).

### B.3.2 Sewer diameter

The sewer diameter is based on the peak flow at the end of the design period ( $q_f$  – units: m<sup>3</sup>/s). The Gauckler-Manning flow equation is rewritten with  $i = I_{\min}$  (the value calculated above with  $q = q_i$ ) and rearranged, as follows:

$$D = n^{3/8} k_a^{-3/8} k_r^{-1/4} (q_f / I_{\min}^{1/2})^{3/8}$$

Thus, with  $n = 0.013$ ,  $k_a = 0.6736$  and  $k_r = 0.3042$  (the values for  $d/D = 0.8$ , the maximum value used in simplified sewerage):

$$D = 0.3064 (q_f / I_{\min}^{1/2})^{3/8}$$

In this equation  $D$  is in m and  $q_f$  in m<sup>3</sup>/sec (not mm, not l/s). The calculated value of  $D$  is unlikely to be a commercially available size of sewer, so the next size up is chosen.

► **The minimum sewer diameter used in simplified sewerage is 100 mm.**

Alternatively the sewer diameter can be selected by using Table A2 as follows:

1. Determine  $q_i$  and  $q_f$  (units: m<sup>3</sup>/s). If  $q_i < 1.5$  l/s (i.e.,  $< 0.0015$  m<sup>3</sup>/s), then use  $q_i = 0.0015$  m<sup>3</sup>/s.
2. Calculate  $I_{\min}$ .
3. Calculate  $\frac{q_f}{I_{\min}^{1/2}}$  [Note:  $q_f$ , not  $q_i$ ].
4. Find this value of  $q_f / I_{\min}^{1/2}$  in Table B2 where  $d/D$  is closest to 0.8.
5. The sewer diameter is given at the top of the column where this value of  $q_f / I_{\min}^{1/2}$  is found.

*Example**(a) sewer diameter*

Suppose  $I_{\min} = 0.005$  (i.e., 5‰ or 1 in 200) and  $q_f = 0.0025 \text{ m}^3/\text{s}$  (i.e., 2.5 l/s). So:

$$\frac{q_f}{I_{\min}^{1/2}} = \frac{0.0025}{0.005^{1/2}} = 0.035$$

This value appears twice in Table B2: at  $d/D = 0.60$  for  $D = 100 \text{ mm}$ , and at  $d/D = 0.32$  for  $D = 150 \text{ mm}$ . Choose the smaller diameter, so  $D = 100 \text{ mm}$ .

*(b) number of people served*

If  $w = 100$  litres per person per day, how many people can discharge their wastewater into this 100-mm diameter sewer laid at a gradient of 1 in 200? The peak flow per person is:

$$k_1 k_2 w / 86,400 = (1.8 \times 0.85 \times 100) / 86,400 = 0.00177 \text{ l/s}$$

The sewer is designed for a peak flow of 2.5 l/s, so the number of people who can safely discharge their wastewater into the sewer is:

$$\frac{2.5}{0.00177} = \sim 1,400 \text{ (or, for example, } \sim 175 \text{ households of 8 persons per household).}$$



**Table B2. Design table for selection of sewer diameter based on the Gauckler-Manning equation with  $n = 0.013$ ,  $q_f$  in  $m^3/s$  and  $D$  in mm.**

$d/D$	Value of $q_f / I_{\min}^{1/2}$			
	$D = 100$	$D = 150$	$D = 225$	$D = 300$
0.20	0.0045	0.0133	0.0393	0.0847
0.22	0.0055	0.0162	0.0477	0.1026
0.24	0.0065	0.0192	0.0567	0.1221
0.26	0.0076	0.0225	0.0665	0.1431
0.28	0.0088	0.0261	0.0769	0.1656
0.30	0.0101	0.0298	0.0879	0.1894
0.32	0.0115	0.0338	0.0996	0.2144
0.34	0.0129	0.0379	0.1118	0.2407
0.36	0.0143	0.0422	0.1245	0.2681
0.38	0.0158	0.0467	0.1377	0.2965
0.40	0.0174	0.0513	0.1513	0.3259
0.42	0.0190	0.0561	0.1653	0.3561
0.44	0.0207	0.0610	0.1797	0.3870
0.46	0.0224	0.0659	0.1944	0.4187
0.48	0.0241	0.0717	0.2094	0.4509
0.50	0.0258	0.0761	0.2245	0.4835
0.52	0.0276	0.0813	0.2398	0.5165
0.54	0.0294	0.0866	0.2553	0.5497
0.56	0.0311	0.0918	0.2707	0.5831
0.58	0.0329	0.0971	0.2862	0.6164
0.60	0.0347	0.1023	0.3017	0.6497
0.62	0.0365	0.1075	0.3170	0.6827
0.64	0.0382	0.1127	0.3321	0.7153
0.66	0.0399	0.1177	0.3471	0.7474
0.68	0.0316	0.1227	0.3617	0.7789
0.70	0.0432	0.1275	0.3759	0.8096
0.72	0.0448	0.1322	0.3897	0.8393
0.74	0.0464	0.1367	0.4030	0.8680
0.76	0.0478	0.1410	0.4157	0.8953
0.78	0.0492	0.1451	0.4277	0.9211
0.80	0.0505	0.1489	0.4389	0.9452

### B.3.3 Hydrogen sulphide control

Hydrogen sulphide ( $H_2S$ ) control is important in concrete sewers as corrosion of the sewer crown can occur (Figure B3). If  $H_2S$  generation is likely, then concrete sewers should not be used. PVC sewers should be used instead. The likelihood of  $H_2S$  generation is determined by calculating the ‘Pomeroy Z factor’:<sup>[6]</sup>

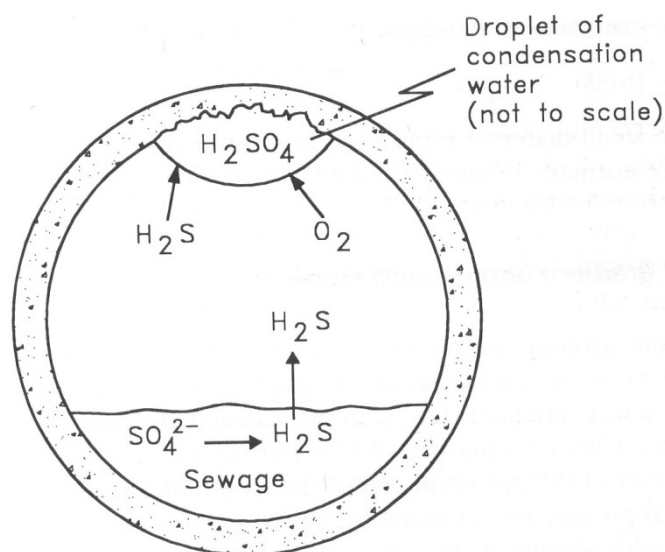
$$Z = 3 (\text{BOD}) (1.017)^{T-20} i^{-1/2} q^{-1/3} (p/b)$$

where BOD = the 5-day 20°C biochemical oxygen demand of the wastewater, mg/l;  $T$  = temperature, °C;  $i$  = sewer gradient, m/m;  $p$  = wetted perimeter, m; and  $b$  = breadth of flow, m.

The value of  $Z$  calculated from this equation is used diagnostically as follows:

- $Z < 5000$ :  $H_2S$  generation unlikely,
- $5000 < Z < 10,000$ :  $H_2S$  generation possible,
- $Z > 10,000$ :  $H_2S$  generation very likely.

With simplified sewerage  $Z$  values are almost always  $> 10,000$ , so PVC or vitrified clay sewers (rather than concrete or asbestos-cement sewers) should be used.



**Figure B3: Microbially induced corrosion of the crown of concrete sewers.**

Sulphates ( $SO_4^{2-}$ ) in the raw wastewater are reduced anaerobically to sulphides by obligately anaerobic sulphate-reducing bacteria (such as *Desulfovibrio* spp.). Some of these sulphides exist as dissolved  $H_2S$  gas and some of these  $H_2S$  molecules leave the wastewater to raise the  $H_2S$  partial pressure in the atmosphere in the sewer (Henry’s law). Some of the  $H_2S$  molecules in the atmosphere enter droplets of condensation water clinging to the sewer crown (Henry’s law again), where they meet dissolved  $O_2$  molecules and are oxidized by the aerobic bacterium *Thiobacillus thioparus* to sulphuric acid ( $H_2SO_4$ ), which attacks the cement in the concrete. Sewer crown collapse often occurs within 5–10 years in warm climates.

## References

1. *Projeto de Redes Coletoras de Esgoto Sanitário* (Brazilian Standard No. 9649), Associação Brasileira de Normas Técnicas, Rio de Janeiro, 1986.
2. JCO Machado Neto & MT Tsutiya, Tensão trativa: um critério econômico de esgoto, *Revista DAE* 1985, **45** (140), 73–87; available online at: <http://www.revistadae.com.br>.
3. P Gauckler, Études théoriques et pratiques sur l'écoulement et le mouvement des eaux, *Comptes Rendus Hebdomadaires des Séances de l'Académie des Sciences* 1867, **64**, 818–822; available online at: <http://gallica.bnf.fr/ark:/12148/bpt6k3021f.image.r=Gauckler.langEN.f820.pagination>.
4. P Gauckler, Du mouvement de l'eau dans les conduites, *Annales des Ponts et Chaussées* 1868, **15**, 229–281.
5. R Manning, On the flow of water in open channels and pipes, *Transactions of the Institution of Civil Engineers of Ireland* 1890, **20**, 161–207.
6. RD Pomeroy, *The Problem of Hydrogen Sulphide in Sewers*, Clay Pipe Development Association, London, 1990; available online at: <http://www.cpda.co.uk/techn/clay/w2253.pdf>.

Please click the advert

## Who is your target group? And how can we reach them?

At Bookboon, you can segment the exact right audience for your advertising campaign.

Our eBooks offer in-book advertising spot to reach the right candidate.



Contact us to hear more  
[kbm@bookboon.com](mailto:kbm@bookboon.com)



CREDIT SUISSE

DAIMLER



Microsoft

[bookboon.com](http://bookboon.com)

Download free ebooks at [bookboon.com](http://bookboon.com)

# Annex C

## Hydraulic Design of Low-Cost Combined Sewers

Low-cost combined sewerage is rigorously designed to convey both the wastewater flow in dry periods and the stormwater flow resulting from a 5- or 10-year storm (i.e., an extreme rainfall event that may be expected, on average, to occur once every 5 or 10 years). The 5-year stormwater flow is used for residential areas and the 10-year stormwater flow for industrial and commercial areas.<sup>[1]</sup>

### C.1 Basis of Hydraulic Design

The minimum sewer gradient ( $I_{\min}$ ) is determined first according to the principles in section B.3.1 of Annex B, using the dry-season peak wastewater flow from the contributing population, subject to the minimum peak flow of 1.5 l/s.

The sewer diameter is then selected, using the procedure described in section B.3.2 of Annex B and Table C3, for the 5- or 10-year stormwater flow ( $q_s$ ) which is determined as described in section C.2.

► The minimum sewer diameter used in low-cost combined sewerage is 400 mm, and the maximum size of the drainage basin is 12 km<sup>2</sup>.<sup>[1]</sup>

### C.2 Stormwater Flows

The peak flow resulting from a 5- or 10-year storm event can be determined by using the ‘rational method’, which computes the peak flow from the return period, the time of concentration, the storm (rainfall) intensity, and the characteristics of the drainage basin.<sup>[1–8]</sup> Although computer models are now more commonly used,<sup>[9–10]</sup> the rational method is sufficiently accurate for small catchment areas. (In the USA the rational method is commonly referred to as the Kuichling method,<sup>4</sup> and in the UK as the Lloyd-Davies method,<sup>5</sup> although it was first developed by Mulvaney some 40 years earlier.<sup>3</sup>)

The design procedure is as follows:<sup>[8]</sup>

1. Determine the catchment area ( $A$ , ha) to be served by the combined sewer being designed.
2. Select a return period of either 5 years (for residential areas) or 10 years (for industrial and commercial areas).
3. Select a value for the ‘time of concentration’ ( $t_c$ ). This is the time it takes for water falling on the most distant part of the catchment to enter the combined sewer and reach the part of the sewer being designed. For catchment areas <5 ha,  $t_c$  can be taken as 15 minutes, and this value can also be used for larger catchments (up to 20 ha) if the average land slope is >0.5% (1 in 200). For flatter areas this value of  $t_c$  should be increased by 1 minute for each hectare over 4 ha.
4. Determine the maximum rainfall intensity ( $i_{\max}$ , mm/h) for the selected return period and the selected time of concentration. This is obtained from an Intensity-Duration-Frequency (i.e., rainfall intensity–time of concentration–return period) plot for the catchment area; such plots are commonly available from local departments of (urban) hydrology or water resources – an example for a particular catchment area is shown in Figure C1 (this cannot be used for other locations as the I-D-F plots will not be the same).

5. Determine the 'runoff coefficient' ( $C$ , dimensionless). The value of  $C$  depends on (a) the runoff coefficient ( $C_U$ ) for the pervious area (i.e., the total area not paved and not covered by buildings) in the catchment; and (b) the percentage ( $P$ ) of impervious area (i.e., the total impermeable paved area plus the total area covered by buildings) in the catchment. Typical values for  $C_U$  and  $P$  are given in Tables C1 and C2, respectively. The value of  $C$  is then determined from Figure C2 using selected values of  $C_U$  and  $P$  for the catchment area drained by the combined sewer being designed.
6. The peak stormwater flow ( $q_s$ ) is now calculated from:  $q_s = 2.78Ci_{\max}A$ . In this equation  $q_s$  is in l/s,  $i_{\max}$  in mm/h and  $A$  in ha.
7. Finally, the sewer diameter is selected using the procedure described in section B.3.2 of Annex B and Table C3 for the peak flow in the sewer (which is equal to the peak wastewater flow + the peak stormwater flow), subject to a minimum diameter of 400 mm.

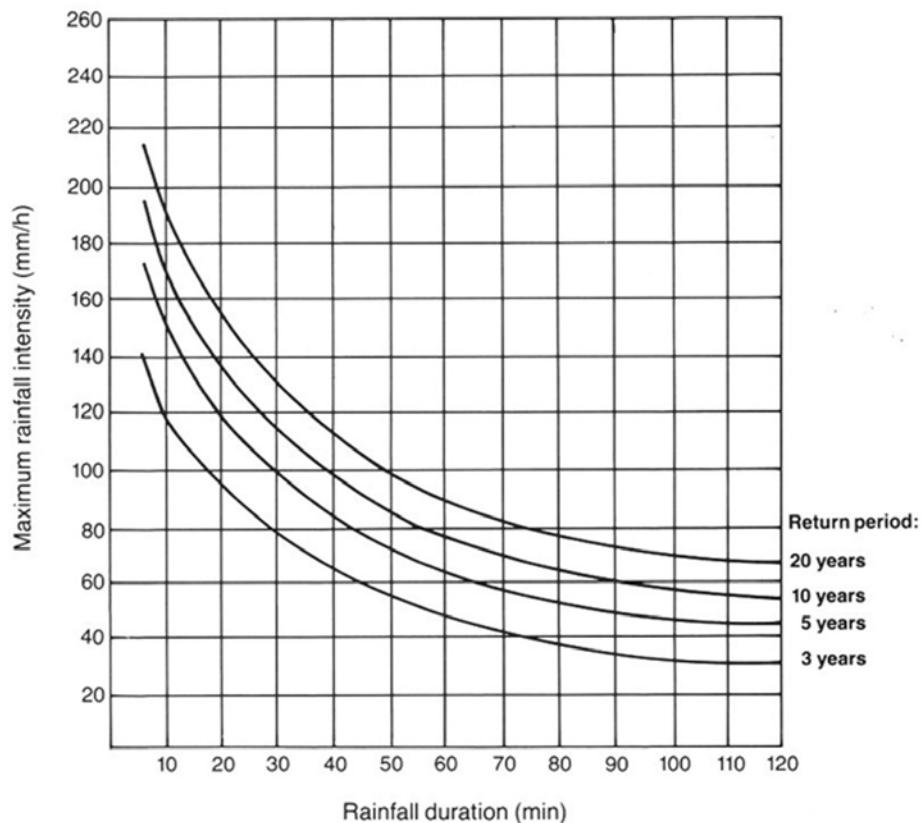


Figure C1: A typical rainfall Intensity-Duration-Frequency plot.<sup>[8]</sup>

**Table C1: Values for the runoff coefficient ( $C_U$ ) for the pervious area (i.e., the area not paved and not covered by buildings) in the catchment<sup>[8]</sup>**

Average ground slope	Soil permeability			
	very low (rock and clay)	low (clay loam)	medium (sandy loam)	high (sand and gravel)
<b>1. HUMID REGIONS</b>				
Flat: 0–1%	0.55	0.40	0.20	0.05
Gentle: 1–4%	0.75	0.55	0.35	0.20
Medium: 4–10%	0.85	0.65	0.45	0.30
Steep: >10%	0.95	0.75	0.55	0.40
<b>2. SEMI-ARID REGIONS</b>				
Flat: 0–1%	0.75	0.40	0.05	0.00
Gentle: 1–4%	0.85	0.55	0.20	0.00
Medium: 4–10%	0.95	0.70	0.30	0.00
Steep: >10%	1.00	0.80	0.50	0.00

**Table C2: Values for the percentage ( $P$ ) of impervious area (i.e., the impermeable paved area plus the area covered by buildings) in low-income urban areas<sup>[8]</sup>**

Population density (persons per ha)	Value of $P$ (%)
0–50	0–12
100	25
200	50
300	75
≥400	100

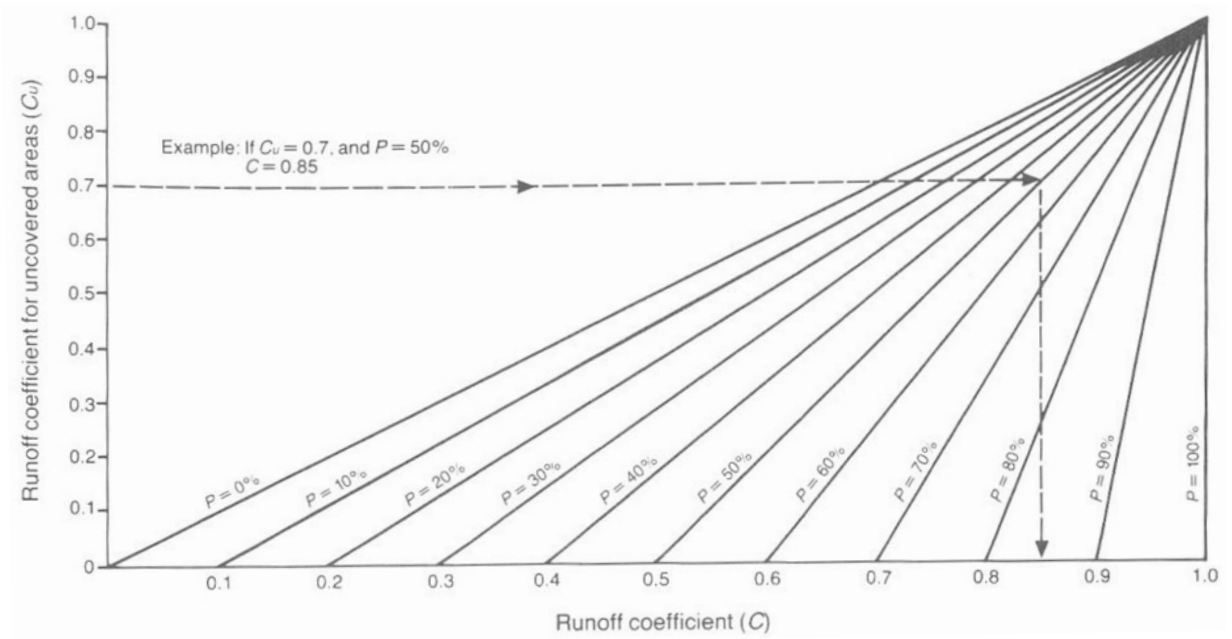


Figure C2: Diagram to determine the value of the runoff coefficient ( $C$ ) from values of  $C_u$  and  $P$ .<sup>[8]</sup>

Please click the advert

**THE BEST MASTER  
IN THE NETHERLANDS**

**Master of Science  
in Management\***

Source: 'Keuzegids Higher Education Masters 2011'.  
\*In category business administration and accountancy & controlling.

**NYENRODE  
BUSINESS UNIVERSITEIT**

**www.nyenrode.nl**

**Table C3. Design table for selection of sewer diameter based on the Gauckler-Manning equation with  $n = 0.013$ ,  $q_s$  in  $m^3/s$  and  $D$  in mm.**

$d/D$	Value of $q_s / I_{min}^{1/2}$			
	$D = 400$	$D = 600$	$D = 800$	$D = 1000$
0.20	0.1824	0.5377	0.8866	1.0288
0.22	0.2210	0.6517	1.0745	1.2469
0.24	0.2630	0.7756	1.2788	1.4839
0.26	0.3083	0.9089	1.4987	1.7391
0.28	0.3566	1.0514	1.7336	2.0116
0.30	0.4078	1.2024	1.9826	2.3007
0.32	0.4618	1.3616	2.2451	2.6052
0.34	0.5184	1.5284	2.5201	2.9243
0.36	0.5774	1.7023	2.8068	3.2570
0.38	0.6386	1.8827	3.1044	3.6023
0.40	0.7018	2.0691	3.4117	3.9590
0.42	0.7669	2.2610	3.7281	4.3260
0.44	0.8336	2.4576	4.0523	4.7023
0.46	0.9017	2.6584	4.3834	5.0865
0.48	0.9710	2.8628	4.7204	5.4775
0.50	1.0413	3.0701	5.0621	5.8741
0.52	1.1123	3.2795	5.4075	6.2749
0.54	1.1839	3.4905	5.7554	6.6785
0.56	1.2557	3.7023	6.1046	7.0837
0.58	1.3276	3.9141	6.4538	7.4890
0.60	1.3992	4.1252	6.8019	7.8929
0.62	1.4702	4.3347	7.1474	8.2939
0.64	1.5405	4.5420	7.4891	8.6903
0.66	1.6097	4.7460	7.8255	9.0807
0.68	1.6775	4.9459	8.1551	9.4632
0.70	1.7436	5.1407	8.4764	9.8360
0.72	1.8076	5.3295	8.7877	10.1972
0.74	1.8693	5.5112	9.0873	10.5448
0.76	1.9281	5.6846	9.3732	10.8767
0.78	1.9837	5.8486	9.6436	11.1904
0.80	2.0356	6.0018	9.8961	11.4834



## References

1. ASP Guimarães & AP de Souza, *Projetos de Pequenos Sistemas Unitários de Esgotamento*, Caixa Econômica Federal, Brasília, 2004.
2. D Butler & JW Davies, *Urban Drainage*, 3rd ed., Taylor & Francis, London, 2010.
3. TJ Mulvaney, On the use of self-registering rain and flood gauges in making observations on the relation of rainfall and flood discharges in a given catchment, *Transactions of the Institution of Civil Engineers of Ireland 1850–51*, **4** (2), 18–33.
4. E Kuichling, The relation between the rainfall and the discharge of sewers in populous districts, *Transactions of American Society of Civil Engineers 1889*, **20**, 1–56.
5. DE Lloyd-Davies, The elimination of storm water from sewerage systems, *Minutes of the Proceedings of the Institution of Civil Engineers 1906*, **164**, 41–67; abstract available online at: <http://dx.doi.org/10.1680/imotp.1906.16637>.
6. LH Watkins, *The Design of Urban Sewer Systems: Research into the Relation between Rate of Rainfall and the Rate of Flow in Sewers*, Road Research Technical Paper No. 55, Her Majesty's Stationary Office, London, 1962.
7. LH Watkins & D Fiddes, *Highway and Urban Hydrology in the Tropics*, Pentech Press, London, 1984.
8. S Cairncross & EAR Ouano, *Surface Water Drainage for Low-income Communities*, World Health Organization, Geneva, 1991; available online at: [http://whqlibdoc.who.int/publications/1991/9241544163\\_eng.pdf](http://whqlibdoc.who.int/publications/1991/9241544163_eng.pdf).
9. W Rauch, K Seggelke, R Brown & P Krebs, Integrated Approaches in Urban Storm Drainage: Where Do We Stand? *Environmental Management 2005*, **35** (4), 396–409; available online at: <http://arts.monash.edu.au/ges/research/nuwgp/pdf/rauch-et-al-05-envt-mgt.pdf>.
10. MIKE URBAN – *Modelling Water in the City*, DHI ([www.dhigroup.com](http://www.dhigroup.com)) webpage at: <http://mikebydhi.com/sitecore/content/Microsites/MIKEbyDHI/Products/Cities/MIKEURBAN.aspx>.

## Further reading

*Queensland Urban Drainage Manual*, 2nd edition, Queensland Department of Natural Resources and Mines, Queensland Division of the Institute of Public Works Engineering Australia, and Brisbane City Council, 2007; available online at: <http://www.derm.qld.gov.au/water/regulation/drainagemanual.html>.

# Annex D

## Useful Websites

Asian Development Bank – Water for All: <http://www.adb.org/Water/default.asp>

Co-operative Programme on Water and Climate: <http://www.waterandclimate.org/>

eldis ('sharing the best in development policy, practice and research'): <http://www.eldis.org/>

Financing Water for All (World Water Council and GWP): <http://www.financingwaterforall.org/>

Global Partnership on Output Based Aid: <http://www.gpoba.org/gpoba/>

Global Public-Private Partnership for Handwashing with Soap: <http://www.globalhandwashing.org/>

Global Water Partnership: <http://www.gwpforum.org/servlet/PSP>

Hygiene Centre, London School of Hygiene & Tropical Medicine: <http://www.hygienecentral.org.uk>

Inter-American Development Bank – Water and Sanitation: <http://www.iadb.org/topics/water/waterinitiative/>

International Institute for Environment & Development: <http://www.iied.org/>

IRC International Water and Sanitation Centre: <http://www.irc.nl/>

International Water Association: <http://www.iwahq.org>

IWA Publishing – journals: <http://www.iwaponline.com/default.htm>

Organisation for Economic Co-operation and Development – The Water Challenge: [http://www.oecd.org/document/47/0,3343,en\\_2649\\_37425\\_36146415\\_1\\_1\\_1\\_37425,00.html](http://www.oecd.org/document/47/0,3343,en_2649_37425_36146415_1_1_1_37425,00.html)

Overseas Development Institute – Water and Sanitation: <http://www.odi.org.uk/themes/water/default.asp>

Practical Action – Water and Sanitation: [http://www.practicalaction.org.uk/our-work/ourwork\\_water](http://www.practicalaction.org.uk/our-work/ourwork_water)

Sandec (Department of Water and Sanitation in Developing Countries), Swiss Federal Institute of Aquatic Science and Technology (Eawag): <http://www.sandec.ch/>

South African Water Research Commission: <http://www.wrc.org.za/>

UN Water: <http://www.unwater.org/flashindex.html>

UN-Habitat – Water and Sanitation: <http://www.unhabitat.org/categories.asp?catid=270>

UNICEF – Water, Environment and Sanitation: <http://www.unicef.org/wes/index.html>

USAID – Water and Environmental Health: [http://www.usaid.gov/our\\_work/environment/water/wrm\\_health.html](http://www.usaid.gov/our_work/environment/water/wrm_health.html) – see also:

(1) Environmental Health at USAID: <http://www.ehproject.org/>

(2) Sanitation Updates: <http://sanitationupdates.wordpress.com/>

(3) Urban Health Updates: <http://urbanhealthupdates.wordpress.com/>

Water and Gender Alliance: <http://www.genderandwater.org/>

Water and Sanitation Program: <http://www.wsp.org/>

Water Research Group, Bradford University, UK: <http://splash.bradford.ac.uk/home/>

WaterAid: <http://www.wateraid.org>

WaterAid America: <http://www.wateraidamerica.org/>

WaterAid Australia: <http://www.wateraid.org/australia/>

WaterAid Sweden: <http://www.wateraid.se/>

WEDC (Water, Engineering and Development Centre), University of Loughborough, UK: <http://wedc.lboro.ac.uk/index.php>; see also: WELL: <http://www.lboro.ac.uk/well/>

World Bank – Water and Sanitation: <http://go.worldbank.org/GJ7BOASPG0>

World Water Council: <http://www.worldwatercouncil.org/>

World Health Organization – Water, Sanitation and Health:

[http://www.who.int/water\\_sanitation\\_health/en/](http://www.who.int/water_sanitation_health/en/)

World Health Organization and UNICEF Joint Monitoring Programme (JMP): <http://www.wssinfo.org/>

– **and ours:**

Duncan Mara: <http://www.personal.leeds.ac.uk/~cen6ddm> and <http://www.duncanmarasanitation.blogspot.com/>

Barbara Evans: <http://www.personal.leeds.ac.uk/~cenbee>

**Keep up to date – subscribe to these email newsletters and alerts:**

*Source Weekly* (IRC): <http://www.antenna.nl/mailman/listinfo/source-weekly>

*ACCESS* (WSP): <http://www.wsp.org/wsp/newsletters>

ContentAlerts for IWA journals: register first at <http://www.iwapublishing.com/template.cfm?name=mailings>; then select to receive ContentAlerts for – for example – *Journal of Water and Health*, *Water Policy*, *Journal of Water and Climate Change*, and *Journal of Water Sanitation and Hygiene for Development*.

New Issue Alerts for *Waterlines* (Practical Action): register first at <http://www.ingentaconnect.com/alerts/journals/AddAlert;jsessionid=dp191cd3ilerr.victoria?journal=pubinfobike://itpub/wtl&newversion=>

# Abbreviations and acronyms

CBO	Community-Based Organisation
CDC	Centre For Disease Control And Prevention
CHC	Community Health Club
CLTS	Community-Led Total Sanitation
DALY	Disability-Adjusted Life Years
ha	Hectare (10,000 Square Metres)
IBT	Increasing Block Tariff
IMR	Infant Mortality Rate
K	Potassium
kN/m <sup>2</sup>	Kilonewton Per Square Metre
LEB	Life Expectancy At Birth
lpd	Litres Per Person Per Day
LSHTM	The London School Of Hygiene And Tropical Medicine
MDG	Millennium Development Goal
MPA	Methodology For Participatory Assessment
N	Nitrogen
NGO	Non-Governmental Organisation
NPV	Net Present Value
OD	Open Defecation

Please click the advert

## Do your employees receive the right training?

Bookboon offers an eLibrary with a wide range of Soft Skill training & Microsoft Office books to keep your staff up to date at all times.



Contact us to hear more  
[kbm@bookboon.com](mailto:kbm@bookboon.com)



CREDIT SUISSE

DAIMLER



Microsoft

[bookboon.com](http://bookboon.com)

ODF	Open-Defecation Free
-----	----------------------