



Natural  
Resources  
Conservation  
Service

October 2010

Technical Note No. 28  
PORTLAND, OREGON

---

---

# Design of Small Photovoltaic (PV) Solar-Powered Water Pump Systems



Issued October 2010

Cover photo courtesy of Nicholle Kovach, Basin Engineer, USDA NRCS.

Trade names mentioned are for specific information and do not constitute a guarantee or warranty of the product by the Department of Agriculture or an endorsement by the Department over other products not mentioned.

The U.S. Department of Agriculture (USDA) prohibits discrimination in all its programs and activities on the basis of race, color, national origin, age, disability, and where applicable, sex, marital status, familial status, parental status, religion, sexual orientation, genetic information, political beliefs, reprisal, or because all or a part of an individual's income is derived from any public assistance program. (Not all prohibited bases apply to all programs.) Persons with disabilities who require alternative means for communication of program information (Braille, large print, audiotape, etc.) should contact USDA's TARGET Center at (202) 720-2600 (voice and TDD).

To file a complaint of discrimination, write to USDA, Director, Office of Civil Rights, 1400 Independence Avenue, SW., Washington, DC 20250-9410, or call (800) 795-3272 (voice) or (202) 720-6382 (TDD). USDA is an equal opportunity provider and employer.

## ACKNOWLEDGEMENTS

---

This technical note was written by **Teresa D. Morales**, Oregon State Design Engineer, United States Department of Agriculture (USDA) Natural Resources Conservation Service (NRCS), Portland, Oregon, and **John Busch**, Oregon State Irrigation Engineer, USDA NRCS, Baker City, Oregon.

Drawings by **Kristi Yasumiishi**, Civil Engineering Technician, USDA NRCS, Portland, Oregon.

Reviewed by **Dave Dishman**, Oregon State Engineer, USDA NRCS, Portland, Oregon; **Stefanie Aschmann**, Leader of Energy Technology Development Team, NRCS West National Technology Support Center (WNTSC), Portland, Oregon; **Peter Robinson**, Water Management Engineer, NRCS WNTSC, Portland, Oregon; **Clarence Prestwich**, Irrigation Engineer, NRCS WNTSC, Portland, Oregon; **Kip Yasumiishi**, Civil Engineer, NRCS WNTSC, Portland, Oregon; **Kelly Albers**, Basin Engineer, USDA NRCS, Tangent, Oregon; **Ginny Cairo**, Basin Engineer, USDA NRCS, Roseburg, Oregon; **Bill Cronin**, Basin Engineer, USDA NRCS, Medford, Oregon; **Kevin Shaw**, Basin Engineer, USDA NRCS, Baker City, Oregon.

Edited by **Erin McDuff**, Administrative Assistant, USDA NRCS, Portland, Oregon.

## **PREFACE**

---

The intent of this technical publication is to provide general guidance on the design of small solar-powered water pump systems for use with livestock operations or irrigation systems. This document provides a review of the basic elements of electricity, a description of the different components of solar-powered water pump systems, important planning considerations, and general guidance on designing a solar-powered water pump system. This publication also provides design examples for typical design scenarios and standard drawings for use by the reader. However, this technical note is not intended to be used as a standalone document. Instead, users are encouraged to consult the NRCS National Engineering Manual (NEH 210) on hydraulics and irrigation engineering for additional assistance in the design of water delivery systems.

All sources used in the development of this technical note are provided in the References section at the back of the document.

# CONTENTS

---

<b>1. INTRODUCTION .....</b>	<b>1</b>
1.0 ELECTRICITY BASICS .....	2
1.1 THE PHOTOELECTRIC EFFECT .....	2
<b>2. SOLAR RADIATION, SOLAR IRRADIANCE, AND SOLAR INSOLATION .....</b>	<b>3</b>
2.0 SEASONAL AND LATITUDE VARIATION .....	5
2.1 CLOUD COVER .....	5
<b>3. PHOTOVOLTAIC (PV) PANELS .....</b>	<b>6</b>
3.0 PV PANEL ELECTRICAL CHARACTERISTICS .....	6
3.1 PV PANEL ORIENTATION AND TRACKING .....	7
3.2 ENVIRONMENTAL FACTORS .....	8
<b>4.0 STRUCTURE AND FOUNDATION CONSIDERATIONS.....</b>	<b>8</b>
4.0 STRUCTURAL SUPPORTS FOR PV PANELS.....	8
4.1 MOUNTING POSTS .....	8
4.2 EMBEDMENT CONSIDERATIONS FOR MOUNTING POSTS.....	9
4.3 CORROSION PROTECTION.....	9
<b>5.0 ELECTRICAL CONTROLLERS .....</b>	<b>10</b>
<b>6.0 SOLAR-POWERED PUMPS .....</b>	<b>11</b>
6.0 PUMP SELECTION AND SYSTEM DESIGN .....	11
6.1 SOLAR-POWERED PUMP CHARACTERISTICS .....	13
<b>7. DESIGN PROCESS .....</b>	<b>14</b>
7.0 STEP 1 – WATER REQUIREMENT .....	14
7.1 STEP 2 – WATER SOURCE .....	14
7.2 STEP 3 – SYSTEM LAYOUT.....	15
7.3 STEP 4 – WATER STORAGE .....	17
7.4 STEP 5 – SOLAR INSOLATION AND PV PANEL LOCATION.....	17
7.5 STEP 6 – DESIGN FLOW RATE FOR THE PUMP .....	17
7.6 STEP 7 – TOTAL DYNAMIC HEAD (TDH) FOR THE PUMP .....	18
7.7 STEP 8 – PUMP SELECTION AND ASSOCIATED POWER REQUIREMENT .....	18
7.8 STEP 9 – PV PANEL SELECTION AND ARRAY LAYOUT .....	18
7.9 STEP 10 – PV ARRAY MOUNTING AND FOUNDATION REQUIREMENTS.....	18
7.10 STEP 11 – WATER FLOW RATES AND DELIVERY POINT PRESSURE .....	19
7.11 STEP 12 – SUMMARY DESCRIPTION OF THE SYSTEM.....	19
<b>8. ADDITIONAL CONSIDERATIONS .....</b>	<b>19</b>

## APPENDIXES

<b>APPENDIX A:</b>	<b>REFERENCES .....</b>	<b>20</b>
<b>APPENDIX B:</b>	<b>ADDITIONAL RESOURCES.....</b>	<b>21</b>
<b>APPENDIX C:</b>	<b>DESIGN EXAMPLES .....</b>	<b>22</b>
	DESIGN EXAMPLE 1: SOLAR-POWERED WATER PUMP SYSTEM USING SURFACE WATER (A STREAM) AS A WATER SOURCE .....	22
	DESIGN EXAMPLE 2: SOLAR-POWERED WATER PUMP SYSTEM USING SUBSURFACE WATER (A WELL) AS A WATER SOURCE ...	28
<b>APPENDIX D:</b>	<b>SOLAR INSOLATION VALUES FOR OREGON .....</b>	<b>36</b>
<b>APPENDIX E:</b>	<b>NREL APPROACH TO DETERMINING SOLAR INSOLATION VALUES .....</b>	<b>46</b>
<b>APPENDIX F:</b>	<b>STANDARD DRAWINGS.....</b>	<b>50</b>
<b>APPENDIX G:</b>	<b>FRICTION HEAD LOSS FOR SCHEDULE 40 PVC PLASTIC PIPE .....</b>	<b>56</b>
<b>APPENDIX H:</b>	<b>SAMPLE WELL LOG .....</b>	<b>57</b>
<b>APPENDIX I:</b>	<b>OREGON DEPARTMENT OF FISH AND WILDLIFE FISH SCREENING CRITERIA.....</b>	<b>58</b>
<b>APPENDIX J:</b>	<b>SOLAR PANEL WIRING .....</b>	<b>60</b>
<b>APPENDIX K:</b>	<b>GLOSSARY OF SOLAR-POWERED WATER PUMP TERMS.....</b>	<b>61</b>

## LIST OF FIGURES

<b>FIGURE 1</b>	<b>– A TYPICAL SOLAR-POWERED WATER PUMP SYSTEM, WHICH INCLUDES A SOLAR ARRAY, CONTROLLER, PUMP, AND STORAGE TANK. (SOURCE: “THE MONTANA AGSOLAR PROJECT – EXPANDING THE AGRICULTURAL USES OF SOLAR ENERGY IN MONTANA.”)</b>	<b>1</b>
<b>FIGURE 2</b>	<b>– THE PHOTOELECTRIC EFFECT AND SUBSEQUENT ELECTRON MOTION. (IMAGE INSPIRED BY .....</b>	<b>3</b>
<b>FIGURE 3</b>	<b>– SOLAR IRRADIANCE AND PEAK SUN HOURS. ....</b>	<b>4</b>
<b>FIGURE 4</b>	<b>– EXAMPLE SUMMER AND WINTER SUN ELEVATION AND ANGLE. (SOURCE: “RENEWABLE ENERGY PRIMER-SOLAR.”) .....</b>	<b>5</b>
<b>FIGURE 5</b>	<b>– SOLAR CELL, PV SOLAR PANEL, AND PV PANEL ARRAY. (SOURCE: “GUIDE TO SOLAR POWERED WATER.....</b>	<b>6</b>
<b>FIGURE 6</b>	<b>– SOLAR PANEL TILT ANGLES: WINTER TILT WITH MORE ANGLE FROM HORIZONTAL [LEFT] AND SUMMER TILT WITH LESS.....</b>	<b>8</b>
<b>FIGURE 7</b>	<b>– PV SOLAR ARRAY WITH STORAGE TANK AND STOCK. ....</b>	<b>11</b>
<b>FIGURE 8</b>	<b>– TYPICAL SURFACE INSTALLATION WITH PERTINENT PARAMETERS. ....</b>	<b>12</b>
<b>FIGURE 9</b>	<b>– TYPICAL WELL INSTALLATION WITH PERTINENT PARAMETERS.....</b>	<b>12</b>
<b>FIGURE 10</b>	<b>– EXAMPLE SOLAR-POWERED PUMP PERFORMANCE CURVES FOR A POSITIVE DISPLACEMENT PUMP.....</b>	<b>13</b>
<b>FIGURE 11</b>	<b>– EXAMPLE SOLAR-POWERED PUMP PERFORMANCE CURVES FOR A CENTRIFUGAL PUMP. ....</b>	<b>13</b>
<b>FIGURE 12</b>	<b>– A PLAN OF AN EXAMPLE WATERING SYSTEM WITH A STORAGE TANK AND PV ARRAY. ....</b>	<b>16</b>
<b>FIGURE 13</b>	<b>– ELEMENTS OF A TYPICAL INSTALLATION SUPPLIED BY A SURFACE WATER SOURCE. ....</b>	<b>16</b>

## LIST OF TABLES

---

<i>TABLE 1 – ELECTRICITY FOR NON-ELECTRICAL .....</i>	<i>2</i>
<i>TABLE 2 – SOLAR RADIATION FOR FLAT-PLATE COLLECTORS FACING SOUTH AT A FIXED TILT OF 43° FOR NORTH BEND, OR.....</i>	<i>4</i>
<i>TABLE 3 – EXAMPLE PV SOLAR PANEL ELECTRICAL .....</i>	<i>6</i>
<i>TABLE 4 – TYPICAL WATER USE REQUIREMENTS .....</i>	<i>14</i>

## LIST OF EQUATIONS

---

<i>EQUATION 1.....</i>	<i>2</i>
<i>EQUATION 2.....</i>	<i>2</i>
<i>EQUATION 3.....</i>	<i>18</i>

## 1. INTRODUCTION

Photovoltaic (PV) panels are often used for agricultural operations, especially in remote areas or where the use of an alternative energy source is desired. In particular, they have been demonstrated time and time again to reliably produce sufficient electricity directly from solar radiation (sunlight) to power livestock and irrigation watering systems.

A benefit of using solar energy to power agricultural water pump systems is that increased water requirements for livestock and irrigation tend to coincide with the seasonal increase of incoming solar energy. When properly designed, these PV systems can also result in significant long-term cost savings and a smaller environmental footprint compared to conventional power systems.

The volume of water pumped by a solar-powered system in a given interval depends on the total amount of solar energy available in that time period. Specifically, the flow rate of the water pumped is determined by both the intensity of the solar energy available and the size of the PV array used to convert that solar energy into direct current (DC) electricity.

The principle components in a solar-powered water pump system (shown in Figure 1, right) include:

- The PV array and its support structure,
- An electrical controller, and
- An electric-powered pump.

It is important that the components be designed as part of an integrated system to ensure that all the equipment is compatible and that the system operates as intended. It is therefore recommended that all components be obtained from a single supplier to ensure their compatibility.

The following information is required to design a PV-powered pump:

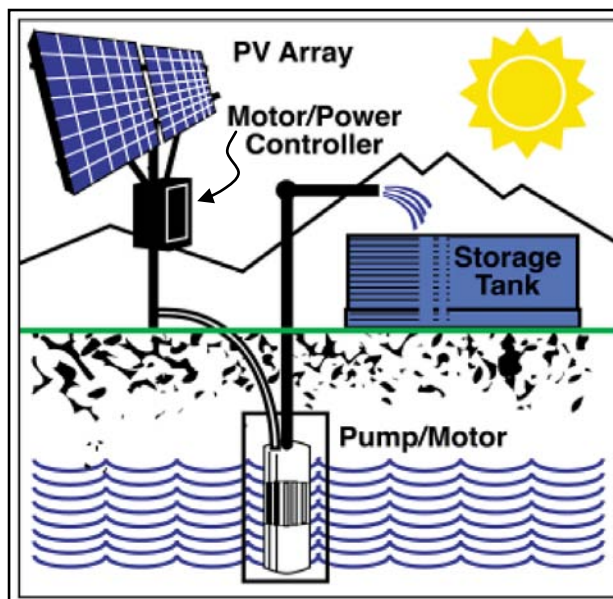

**Figure 1** – A typical solar-powered water pump system, which includes a solar array, controller, pump, and storage tank. (Source: “The Montana Agsolar Project – Expanding the Agricultural Uses of Solar Energy in Montana.”)

- The site-specific solar energy available (referred to as “solar insolation”).
- The volume of water required in a given period of time for livestock or irrigation purposes, as well as for storage. (A storage volume equal to a three-day water requirement is normally recommended for livestock operations as a backup for the system’s safety features and cloudy days.)
- The total dynamic head (TDH) for the pump.
- The quantity and quality of available water.
- The system’s proposed layout and hydraulic criteria.

The following sections will first provide an introduction to the basic concepts involved in solar-powered pump systems, then descriptions of and design considerations for the previously mentioned, individual system components. (See Appendix K: Glossary of Solar-Powered Water Pump Terms for definitions of the technical terms and abbreviations used.)



### 1.0 Electricity Basics

It is important to be familiar with fundamental electrical concepts, such as energy, voltage, amperage, and resistance, before you begin to design a solar-powered water pump system.

Voltage is the electrical potential (i.e. the pressure) in the solar-powered system. It is measured in units of Volts (V).

Amperage refers to the movement or flow of electrons (i.e. the electrical current) through the system. It is measured in units of Amps (A).

Voltage multiplied by amperage is the power produced. It is measured in units of watts (Pw), as shown in Equation 1:

$Watts = Volts \times Amps$
-----------------------------

**Equation 1**

Electrical energy is the amount of power generated over a period of time. Energy is typically measured in kilowatt-hours (kWh).

Lastly, resistance is a measure of a material's resistance to the flow of electrons across it. It is measured in Ohms ( $\Omega$ ).

A good analogy to help describe the flow of electrons in a wire is the flow of water through a pressurized line. In order to illustrate this analogy, Table 1 (right) compares the flow of electricity through a circuit with the flow of water through a pipe.

As with water flowing through a pipe, resistance (friction, in the case of water) in the electrical line results in an energy loss in the system. It is influenced by the length, size, and type of wire conductor. Specifically, resistance is proportional to the length of the wire and inversely proportional to the cross-sectional area of the wire. In other words, the longer the wire, the greater the loss and the larger the wire diameter, the less the loss. The energy

<b>Table 1 – Electricity for Non-Electrical Engineers</b>	
<b>Electricity in a Wire</b>	<b>Water in a Pipe</b>
Amp (flow of electrons)	Q (flow rate of water)
Volts (energy potential)	Pressure (energy potential)
Watts (power) = Amps x Volts	Hydraulic/Water Power = Q x Pressure
Resistance	Friction + Minor Losses
High Voltage, Small Wire = High Amps, High Resistive losses, Heat and Fires	High Pressure, Small Pipe = High Velocity, High Friction Losses, Blown Pipe

loss is also influenced by the wire material: a good conductor, such as copper, has a low resistance and will result in less energy loss.

Another effective way to reduce electrical losses in a system is to decrease the current flow. Power losses in an electrical circuit are proportional to the square of the current, as shown in Equation 2:

$Power\ Loss = Current^2 \times Resistance$
---

**Equation 2**

Consequently, as indicated in Equations 1 and 2, increasing the voltage while reducing the current will result in the same power transmission, but with less power loss. Therefore, higher voltage pumps tend to be more efficient than lower voltage pumps, assuming all other properties are similar.

### 1.1 The Photoelectric Effect

PV systems harness the sun's energy by converting it into electricity via the **photoelectric effect**. This occurs when incoming photons interact with a conductive surface, such as a silicon cell or metal film, and electrons in the material become excited and jump from one conductive layer to the other, as shown in Figure 2, on the following page.

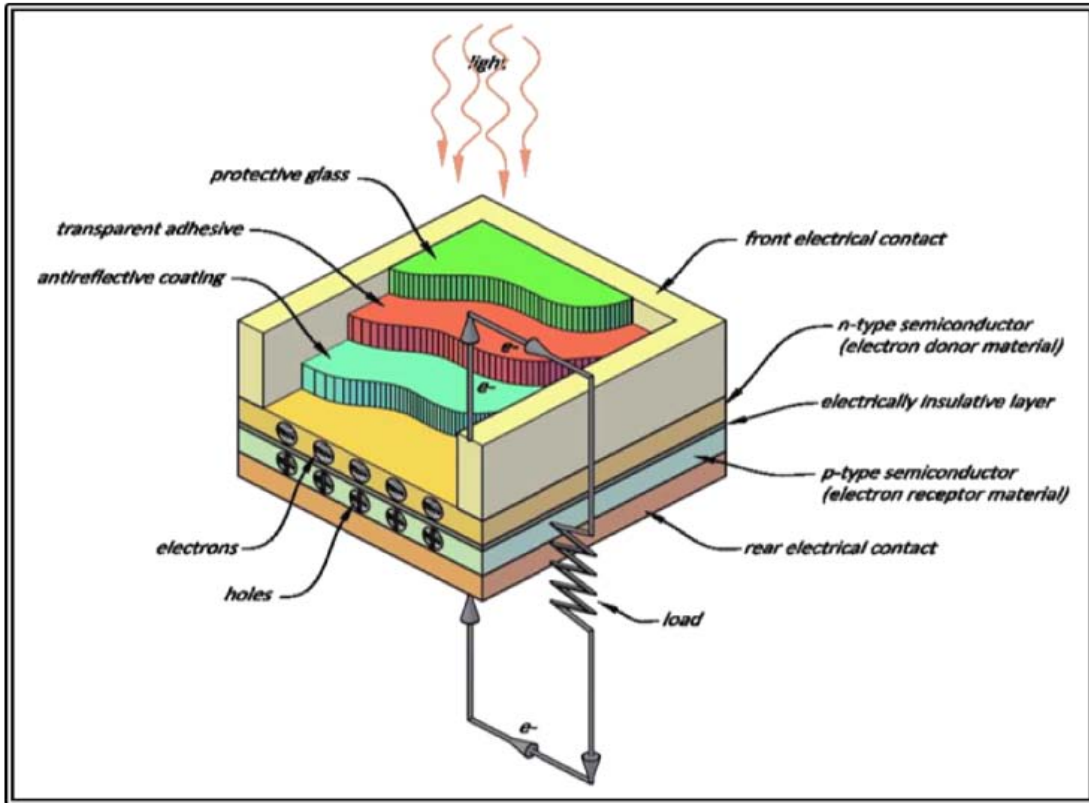

**Figure 2** – The photoelectric effect and subsequent electron motion. (Image inspired by Merriam-Webster, 2006.)

In this figure, the excitation of electrons and their movement from the p-layer to the n-layer results in a voltage differential across the electrical circuit, causing electrons to flow through the rest of the circuit to maintain a charge balance. The system is designed so that there is an electrical load in the external circuit, permitting the current flow to perform a useful function. In other words, the behavior of electrons in the solar cell creates a voltage that can be utilized to, for example, operate a water pump system.

## 2. SOLAR RADIATION, SOLAR IRRADIANCE, AND SOLAR INSOLATION

To design a solar-powered water pump system, you will need to quantify the available solar energy. It is therefore important for you to be familiar with the definitions and distinctions between the three related terms “solar

radiation,” “solar irradiance,” and “solar insolation.”

**Solar radiation** is the energy from the sun that reaches the earth. It is commonly expressed in units of kilowatts per square meter ( $\text{kW}/\text{m}^2$ ). The earth receives a nearly constant  $1.36 \text{ kW}/\text{m}^2$  of solar radiation at its outer atmosphere. However, by the time this energy reaches the earth’s surface, the total amount of solar radiation is reduced to approximately  $1 \text{ kW}/\text{m}^2$ .

The intensity of sunshine (i.e. solar radiation) varies based on geographic location. A good analogy to describe this variation is the different conditions that can be found on the north slope of a mountain versus its south slope.

The intensity of sunlight also varies based on the time of day because the sun’s energy must

pass through different amounts of the earth's atmosphere as the incident angle of the sun changes. Solar intensity is greatest when the sun is straight overhead (also known as solar noon) and light is passing through the least amount of atmosphere. Conversely, solar intensity is least during the early morning and late afternoon hours when the sunlight passes through the greatest amount of atmosphere. In most areas, the most productive hours of sunlight (when solar radiation levels approach 1 kW/m<sup>2</sup>) are from 9:00 a.m. to 3:00 p.m. Outside of this time range, solar power might still be produced, but at much lower levels.

**Solar irradiance**, on the other hand, is the amount of solar energy received by or projected onto a specific surface. Solar irradiance is also expressed in units of kW/m<sup>2</sup> and is measured at the surface of the material. In the case of a PV-powered system, this surface is the solar panel.

Finally, **solar insolation** is the amount of solar irradiance measured over a given period of time. It is typically quantified in peak sun hours, which are the equivalent number of hours per day when solar irradiance averages 1 kW/m<sup>2</sup>. It is important to note that although the sun may be above the horizon for 14 hours in a given day, it may only generate energy equivalent to 6 peak sun hours.

Figure 3, right, demonstrates how peak sun hours are determined for any particular day. The entire amount of solar irradiance (indicated by the blue arc) is divided by 1 kW/m<sup>2</sup>, which equals the total number of peak sun hours for that day (indicated by the white rectangle).

Another term that is synonymous with peak sun hours (solar insolation) is "equivalent full sun

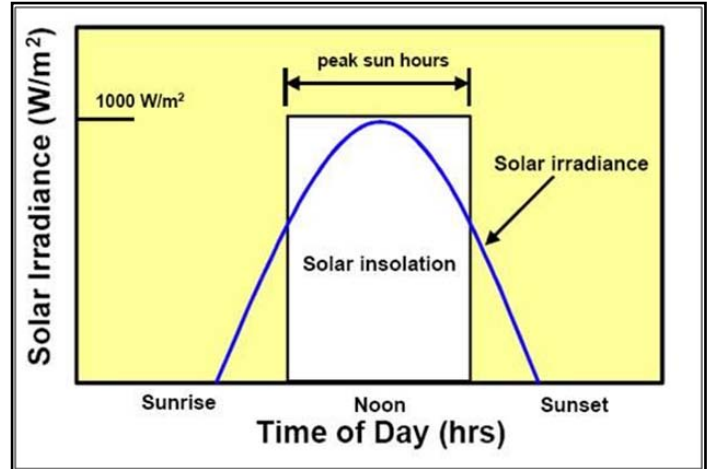

Figure 3 – Solar irradiance and peak sun hours. (Source: "Renewable Energy Primer-Solar.")

hours." Occasionally, the term "solar radiation" can also be used to describe equivalent full sun hours (in addition to the definition above), as in Appendix D.

Two important considerations when determining solar insolation values are the latitude of the project site and the proposed tilt angle of the PV array. (The tilt angle, which is discussed in Section 3.1, is the angle of the panel relative to horizontal where 0° is horizontal and 90° is vertical. Latitude is discussed in Section 2.0). An example of monthly solar insolation values for North Bend, Oregon (latitude 43 degrees) for a fixed tilt angle is shown in Table 2, below. Additional solar insolation (solar radiation) values are provided in Appendix D for nine locations in Oregon. (Data for Boise, Idaho, are also included in Appendix D due to its proximity to eastern Oregon.)

An approach for determining solar insolation values for locations not listed in these solar

North Bend, OR Latitude - 15° = 43 - 15 = 28°	Jan	Feb	Mar	Apr	May	Jun	Jul	Aug	Sep	Oct	Nov	Dec	Year
	2.4	3.0	4.1	5.1	6.8	6.1	6.5	6.5	6.0	5.4	4.0	2.6	4.4

tables has been developed by researchers at the U.S. Department of Energy’s National Renewable Energy Lab (DOE-NREL). NREL has developed two software packages (PVWATTS v. 1 and PVWATTS v. 2) that can determine solar insolation values, as well as cost estimates for different types of solar-powered systems. A simple introduction to how to use PVWATTS v.2 (Beta) FlexViewer is provided in Appendix E.

**2.0 Seasonal and Latitude Variation**

In addition to the variation of sunlight intensity on any given day, the seasonal variation of intensity must also be considered when planning for a solar-powered system. In the northern hemisphere, the least amount of sunlight occurs in the winter because the days are shorter and the sun is lower in the sky, as shown in Figure 4, below. In Oregon specifically, there is also typically increased cloud cover in many regions during the winter months (which is discussed further in the following section). Therefore, sunlight intensity is least during December and greatest during mid-summer in the June – July period.

Adjusting the tilt angle of the PV array to account for seasonal variations in the sun’s elevation can result in increased electrical power output from the array. Additional information on adjusting for tilt angle is provided in Section 3.1.

**2.1 Cloud Cover**

Clouds, fog, and overcast skies are common weather events that occur throughout the year across Oregon, but particularly in the western part of the state during the winter months. Their effects are reflected in the solar insolation data shown in Appendix D. The tables include maximum, minimum, and average values with a ±9 percent uncertainty. Reduction or adjustment of the solar insolation values (equivalent full sun hours) is not needed as the effects of cloud cover are already accounted for. Instead, it is recommended that the designer use the average values included in these tables unless local conditions (such as for sites located under heavy vegetation or in unusual geological features) warrant otherwise.

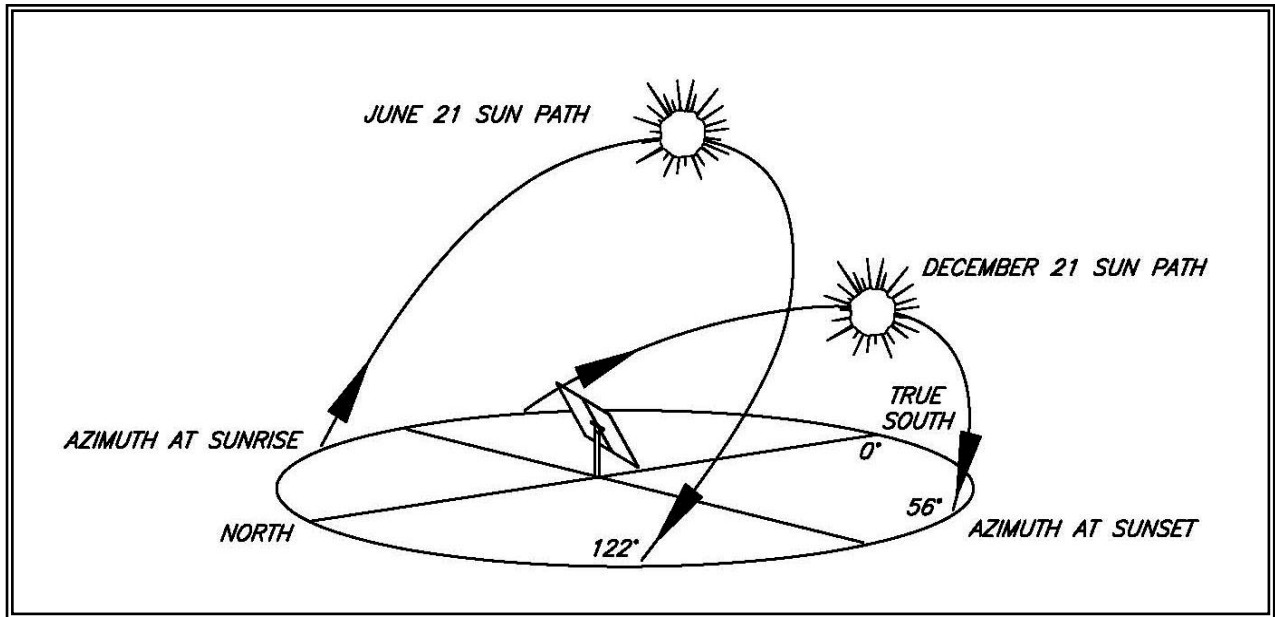

Figure 4 – Example summer and winter sun elevation and angle. (Source: “Renewable Energy Primer-Solar.”)

### 3. PHOTOVOLTAIC (PV) PANELS

PV panels are made up of a series of solar cells, as shown in Figure 5, below. Each solar cell has two or more specially prepared layers of semiconductor material that produce DC electricity when exposed to sunlight. A single, typical solar cell can generate approximately 3 watts of energy in full sunlight.

The semiconductor layers can be either crystalline or thin film. Crystalline solar cells are generally constructed out of silicon and have an efficiency of approximately 15%. Solar cells that are constructed out of thin films, which can consist of a variety of different metals, have efficiencies of approximately 8% to 11%. They are not as durable as silicon solar cells, but they are lighter and considerably less expensive.

PV panels may be arranged in arrays and connected by electrical wiring to deliver power to a pump (see Section 3.0 for more details).

PV panels must meet all NRCS required specifications, both for power production and structural integrity (including resistance to hail), as described in the following sections.

### 3.0 PV Panel Electrical Characteristics

PV panels are rated according to their output, which is based on an incoming solar irradiance of 1 kW/m<sup>2</sup> at a specified temperature. Panel output data include peak power (Watts [Pw]), voltage (Volts [V]), and current (Amps [A]). Under conditions of reduced solar radiation, the current produced is decreased accordingly, but the voltage is reduced only slightly. Example electrical characteristics for a solar panel are shown in Table 3.

**Table 3 – Example PV Solar Panel Electrical Characteristics**

Characteristic	Value	Units
Peak Power	117	Watt [Pw]
Power Tolerance	±5	%
Max Power Voltage	35.5	Volts [V]
Max Power Current	3.3	Amps [A]
Open Circuit Voltage	40.0	Volts [V]
Short Circuit Current	3.5	Amps [A]

Multiple panel arrays should be wired in a series and/or parallel so that the resulting voltage and current are compatible with the controller and pump motor requirements.

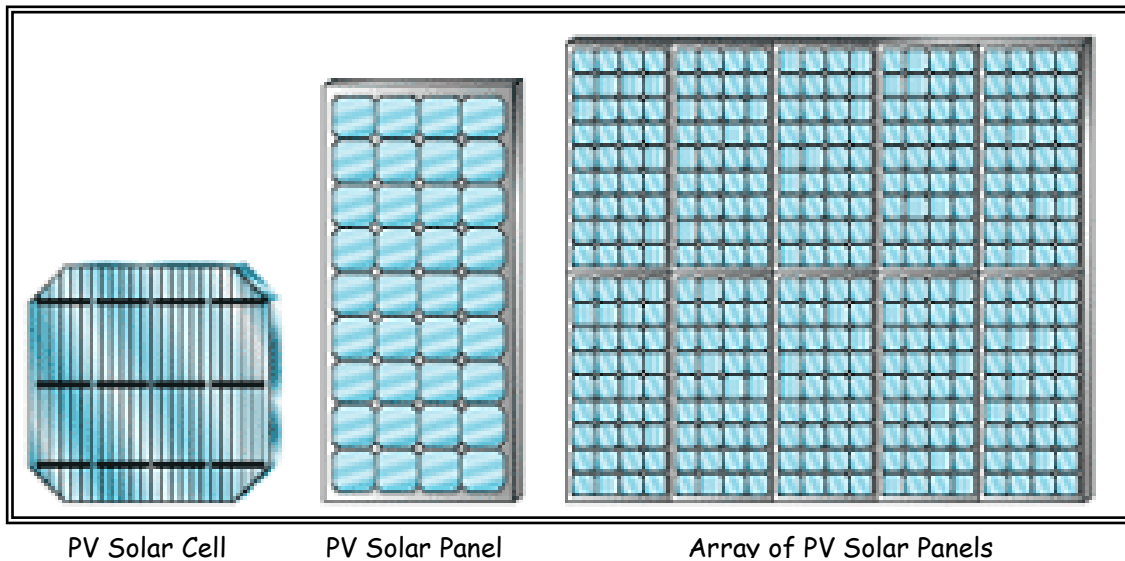

**Figure 5 – Solar cell, PV solar panel, and PV panel array.** (Source: “Guide to Solar Powered Water Pumping Systems in New York State.”)

When multiple panels are wired in a series, the total output voltage is the sum of the individual panel output voltages; the total current stays the same. Conversely, when panels are wired in parallel, the voltage stays the same while the resultant total current is the sum of the individual panel current inputs. The total power output from a PV panel array is determined by multiplying the total output voltage by the total output current. (Basic PV panel wiring diagrams are shown in Appendix J.)

The power output from a PV panel can vary slightly from the panel's rated power, as noted by the "Power Tolerance" value in Table 3. Power output will also decline at about one percent per year due to environmental wear on the system. Oregon Construction Specification 68: Photovoltaic (PV) Power Supply for Pump specifies that the panel output shall be warranted against a degradation of power output in excess of 10 percent in a 10-year period following installation.

### 3.1 PV Panel Orientation and Tracking

To be most effective, PV panels need to continuously and directly face incoming sunlight, which requires the use of one or two tracking mechanisms. A single-axis tracking mechanism will rotate a PV panel about its vertical axis to follow the sun throughout the day. A double-axis mechanism will also control the panel tilt angle (the angle of the panel relative to horizontal where 0° is horizontal and 90° is vertical) to adjust for the elevation of the sun in the sky throughout the year.

Single-axis tracking can be very effective for increasing energy production throughout the year, by up to 50% during some months. Passive single trackers, which require no energy input, can be used. They use the heat from the sun to cause freon or a substitute refrigerant to move between cylinders in the tracker assembly, which causes the panels to shift so that they maintain a constant 90-degree angle to the sun throughout the day. Single-axis

trackers tend to be more appropriate for sites between +/- 30 degrees latitude. Also, their benefits at higher altitudes tend to be less during the winter months when the sun is low on the horizon.

In general, though, due to the complexity of tracking mechanisms and their associated controls, most installations for water pumps are stationary and oriented due south to take advantage of the maximum sunlight available in the middle of the day.

The default tilt angle for a PV panel is equal to the latitude of the location. For a fixed array, this default angle will maximize annual energy production.

A tilt angle of +/- 15 degrees from latitude will increase energy production for the winter or summer months, respectively. Most solar panels that are used for water pumping are set to collect the maximum amount of energy in the summer, when water demands are greatest. However, to maximize energy for both summer and winter pumping, it is recommended that the tilt angle be adjusted at the spring and autumn equinoxes (March 21<sup>st</sup> and September 21<sup>st</sup>). In other words, the panel array tilt angle should be adjusted as follows:

- Summer tilt angle = latitude – 15° (when the sun is higher in the sky).
- Winter tilt angle = latitude + 15° (when the sun is lower in the sky).

For example, latitudes in Oregon range from 42° to 46° north, so summer tilt angles are expected to range from 27° to 31° while winter tilt angles should range from 57° to 61°. (The PV arrays in Figure 6, on the following page, show the different tilt angles for both summer and winter.)

Note that if the array's tilt angle is adjusted seasonally, the site's solar insolation data that is used in the design of the solar-powered water pump system should reflect this.





**Figure 6** – Solar panel tilt angles: winter tilt with more angle from horizontal [left] and summer tilt with less angle from horizontal [right]. (Source: “Renewable Energy Primer-Solar.”)

**3.2 Environmental Factors**

PV panels and all associated components (the mounting structure, power controller, and electrical connections) are subject to a host of environmental stresses, such as high temperatures; dust; significant wind, snow, ice, or hail loading; etc. To withstand such stresses, NRCS requires all components associated with powering a water pump to meet or exceed all current industry standards as specified in Oregon Construction Specification 68.

**4.0 STRUCTURE AND FOUNDATION CONSIDERATIONS**

**4.0 Structural Supports for PV Panels**

The structural supports used to attach the PV panels to their mounting posts are typically provided by the solar panel manufacturer. The supports must be installed per the manufacturer’s specifications to avoid any unintended stresses or eccentric loading to the panels, structural supports, and/or mounting posts. These unintended stresses and/or eccentricities can overstress the connection of the panel to the post, even under normal loading, and damage the system.

Any structural support used to mount the PV panels to the post that has not been provided by a certified solar panel manufacturer needs to

meet all expected load cases as defined in the Oregon Construction Specification 68.

**4.1 Mounting Posts**

A solar panel array mounted to a post behaves essentially in the same way as a sign or billboard and is therefore subject to the same types of ice and wind loading. A properly mounted solar panel array will result in a downward (axial) and lateral point load at the top of the mounting post while minimizing any eccentric loading. Correctly analyzing these loads is essential for determining the correct foundation design and mounting post size.

NRCS has developed three sets of standard drawings for solar-powered water pump systems. Copies of these drawings are located in Appendix F. The first sheet of each set of drawings provides a mounting post selection table. This table provides minimum pipe sizes, embedment depths, and concrete volumes based on the post height and panel array size for a proposed system. The values listed in these tables are based on a wind speed of 95 mph, a 1-inch ice load, and a panel self-weight of 40 lb per panel. Soil properties for the foundation design were presumed to have an allowable bearing pressure of 1,500 psf and a lateral pressure per unit depth of 100 psf/ft .

***The use of this table for site conditions that exceed these design parameters is NOT***

**acceptable.** For a site whose conditions do exceed these design parameters, the required mounting post size and embedment depth will need to be determined by a qualified engineer.

Care should be taken before mounting a solar panel array to an existing structure, such as a barn or shed. The self-weight of the panels can be significant, particularly with larger arrays. Furthermore, the addition of a solar panel array to a roof can change wind loading patterns on that roof. An older structure or a structure not designed to carry these larger loads could potentially be overwhelmed by the addition of a solar panel array and fail.

Any questions regarding the suitability of an existing structure for use in mounting a solar panel array should be directed to a qualified engineer.

#### **4.2 Embedment Considerations for Mounting Posts**

An inadequate embedment depth for the mounting post can cause the panels to tilt or tip over during normal wind and/or ice loading and can lead to significant damage to the PV system. Tilting of the panels will also occur when loading on the panels results in localized failure of the soil column immediately around the post, which will then be able to move freely in the ground. Additional loading may lead to progressive failure of the foundation and/or reduced energy production as the panels will no longer be positioned to receive maximum solar insolation.

To reduce the potential for the panels to tip or tilt, the foundation must be designed to carry the expected wind and ice loads, as determined using the American Society of Civil Engineers (ASCE) 07 Minimum Design Loads for Buildings and Other Structures.

The standard solar-powered water pump system drawings provided in Appendix F call for all post holes to be backfilled with concrete. In

order to ensure adequate foundation strength, the concrete should be properly batched above ground prior to placement in the post hole. It is NOT acceptable to place dry ready mix concrete in the post hole and then backfill the hole with water. This method provides no way to ensure that the concrete has been adequately mixed and the required concrete strength achieved. Instead, the foundation is more likely to fail over time, resulting in a tilting panel and a potential reduction in power generation.

#### **4.3 Corrosion Protection**

Corrosion is a potentially serious issue that can be easily avoided by taking a few simple, protective steps.

For corrosion to occur, the following four elements need to be present:

- 1) Anode – a corroding metal surface
- 2) Cathode – a non-corroding metal surface
- 3) Electrolyte (solution) – a pathway for ionic energy transfer
- 4) Metal Conductor – a pathway for energy transfer

When dissimilar metals (the anode and the cathode) come into contact under wet conditions (the electrolyte), a galvanic potential is created between the anode and the cathode, leading to the subsequent corrosion of the anode. For example, the use of plain carbon steel bolts, nuts, and washers to attach an aluminum mounting structure to the mounting post will begin to corrode the aluminum when the contact area between the bolts, nuts, and washers and the aluminum mounting structure is wet. The aluminum will act as the sacrificial material (anode) since it has a lower galvanic potential than the plain carbon steel.

However, if one of these issues is eliminated, the corrosion will cease. For example, the moisture may be removed or the contact between the mounting panel and bolts, nuts, and washers may be lost. The latter will most



likely occur when the corrosion becomes severe enough to cause the bolted connection to fail. This can result in significant and costly damage to the panel array. In terms of the former solution, since PV-powered systems are continually exposed to the elements, the presence of moisture around the mounting structure connection is simply unavoidable. Selecting hardware that is made of a similar material (i.e. that has a similar galvanic potential) is therefore the best and cheapest defense against corrosion. Overlooking this seemingly minor and inexpensive detail can result in costly damage to the array.

Any questions regarding the appropriate type of fasteners to use should be directed to the manufacturer, installer, and/or a qualified engineer.

## 5.0 ELECTRICAL CONTROLLERS

Electrical controllers and safety devices are incorporated into PV-powered water pump systems to control the electric power input to the pump and to provide necessary electrical protection and switching.

The controller normally includes a main switch to provide an electrical disconnect of the PV array from all other system components. Since the amount of power produced by the array depends on the intensity of incoming solar radiation, the controller can cause the pump to be switched off until sufficient power is available to meet the pump's specified minimum operating power input range. Likewise, when the PV panels produce too much power, the controller can limit the power output to the pump to prevent it from running faster than its maximum rated speed. The performance of the electrical controller will vary depending on the type of controller selected. However, an important safety device that should be included in most systems is a switch for low water dry run protection.

The pump's operation can also be controlled by the use of a float switch in the storage tank, which responds automatically when a preset water level is reached in the tank. Alternatively, the pump's operation can be controlled by a pressure switch, which responds when a designated water pressure is attained in the system.

A PV system may incorporate storage batteries that can be charged when incoming solar energy exceeds the pumping power requirement. The batteries can then be used to power the pump when the pumping requirement exceeds the solar power input. The battery charge and discharge will be regulated by the control unit. The use of batteries, however, does require a more complex control system and can significantly increase the cost and maintenance of the PV-powered system. **Remember, the first goal of a solar-powered water pump system is to store water, not electricity.** The use of batteries should therefore be discouraged unless absolutely necessary since the added expense and complexity usually outweighs any advantages.

A more effective and less expensive means of utilizing excess incoming solar energy would be to incorporate a water storage tank into the system (see Figure 7, on the following page). A storage tank can help meet the operation's water needs when the demand exceeds the pump output or during non-peak solar insolation hours when only minimal solar energy is generated.

For the safety of the equipment and everyone who may come into contact with the pump system, it is important to properly ground all electrical components and solar panel structures to reduce the possibility of damage from lightning strikes.



**Figure 7** – PV solar array with storage tank and stock.  
(Source: “Renewable Energy Primer-Solar.”)

## 6.0 SOLAR-POWERED PUMPS

Pumps that use PV systems are normally powered by DC motors. These motors use the DC output from the PV panels directly. Alternating current (AC) motors are sometimes used, but they require more complex control systems. They also result in less total energy availability due to the electrical losses caused when an inverter is used to convert the DC to AC electricity. Because DC motors do not require an inverter, utilize a less complex control system, and result in more total energy availability, they are most commonly paired with solar-powered pumps.

The type of pump configuration and mounting can be either submersible, surface mount, or floating, depending on the water source.

Solar-powered pumps are characterized as either positive displacement pumps (e.g., diaphragm, piston, or helical rotor) or centrifugal pumps. Positive displacement pumps are typically used when the TDH is **high** and the flow rate (measured in gpm) required is **low**. Conversely, centrifugal pumps are typically used for **low** TDH and **high** flow rates. The TDH and flow rate characteristics for a

given pump can be found in the pump manufacturer’s specifications.

Another important consideration when selecting the appropriate pump is the pump’s minimum voltage. Pump manufacturers may provide pumps with similar operating characteristics but different voltages. As noted in Section 1.2, a higher operating voltage tends to be more efficient since there is less energy loss from the reduced current required to deliver the same power (wattage). This is important when considering the placement of the panels and controller relative to the location of the pump. A general rule of thumb is that if the array consists of four or more panels and is located more than 50 feet away from the pump, the use of a higher voltage pump should be considered.

### 6.0 Pump Selection and System Design

Factors affecting the selection of a solar-powered pump include the following:

- TDH (in feet).
- The water source (surface vs. well).
- The available electrical power (peak power) and energy (total energy, i.e. power x time) produced by the PV panel array.
- The water requirement (flow rate and/or total volume in a given time period, including the storage requirement).

The water quality (including the amount of sediment, organic content, sand, and total dissolved solids [TDS]) may also be a required consideration for selecting a pump, as per the manufacturer’s specifications.

The pertinent parameters needed for the pump system design for typical surface and well installations are shown in Figures 8 and 9, respectively, on the following page.

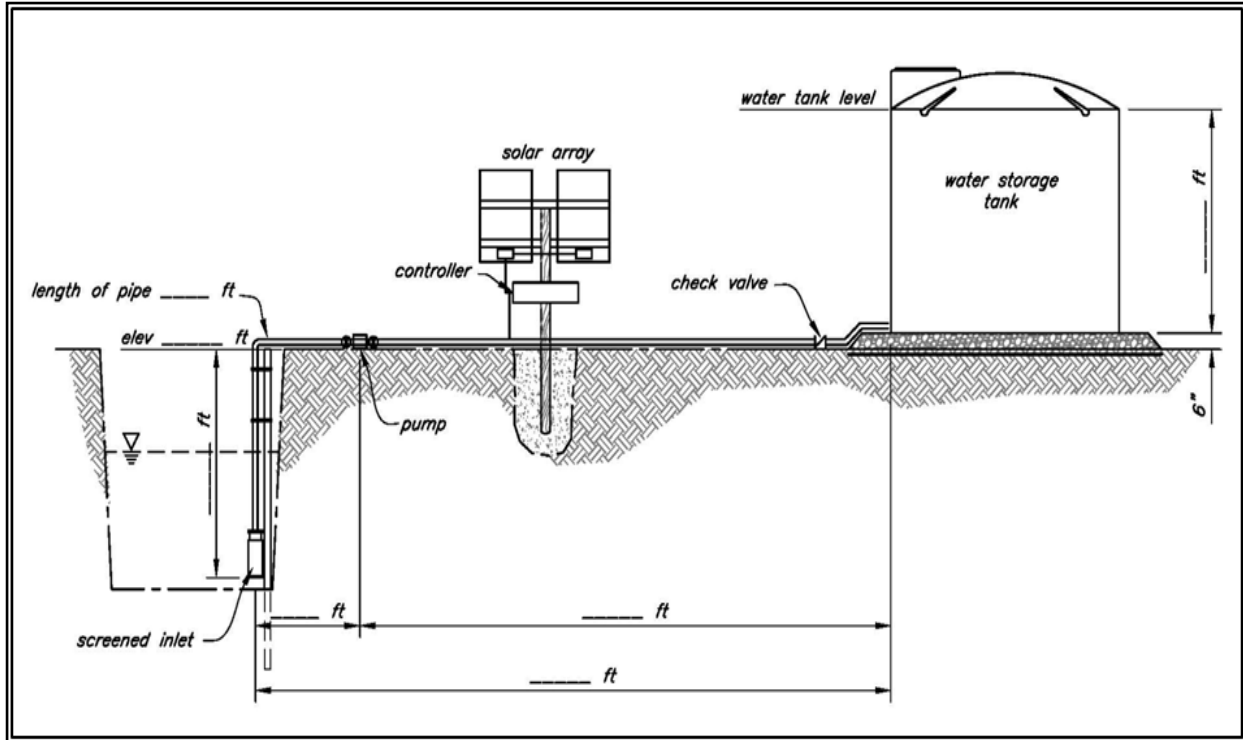

Figure 8 – Typical surface installation with pertinent parameters.

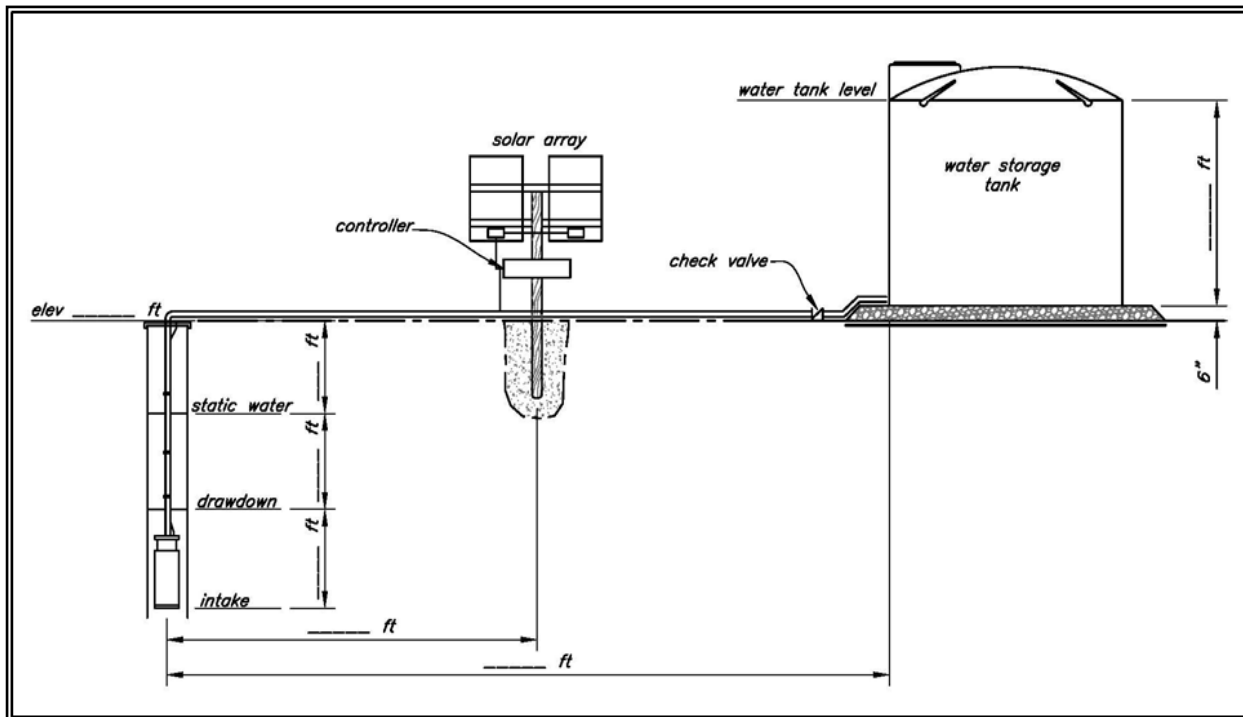

Figure 9 – Typical well installation with pertinent parameters.

### 6.1 Solar-Powered Pump Characteristics

A water pump can be selected using pump performance curves that show the operating characteristics for the solar-powered pump, such as those in Figures 10 and 11, below. The curves in Figure 10 are for positive displacement pumps, and those in Figure 11 are for centrifugal pumps. An explanation of how

to use pump curves is provided in the design examples located in Appendix C.

Alternatively, some suppliers have computer programs and web-based utilities for selecting and sizing pumps for specified values of available solar radiation, pump flow rate, and pumping head.

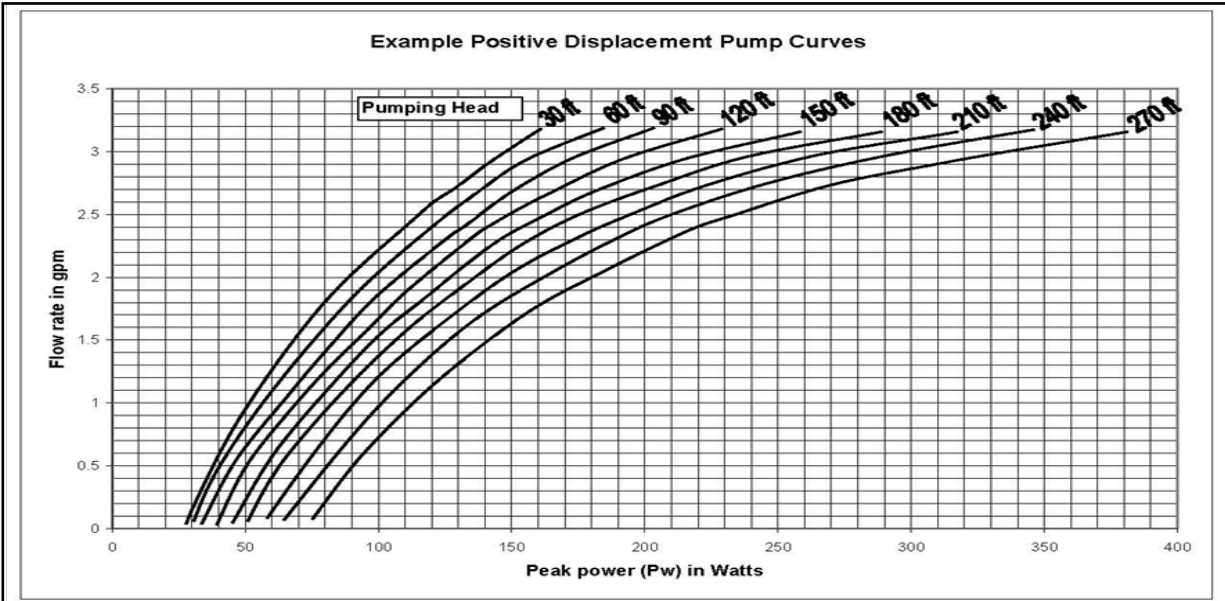

Figure 10 – Example solar-powered pump performance curves for a positive displacement pump.

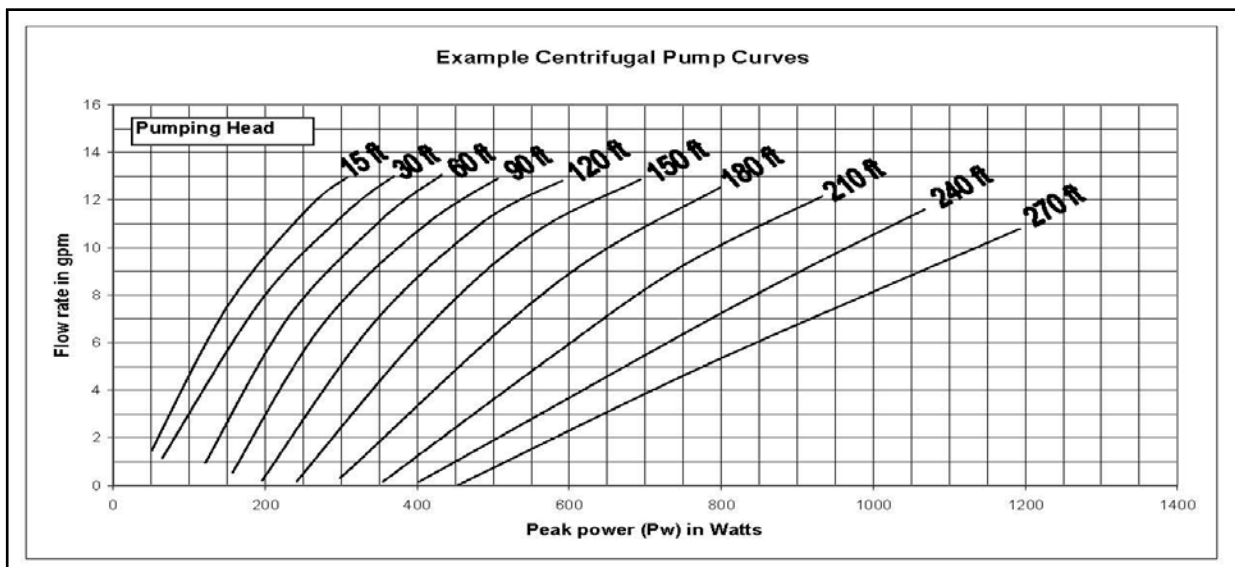

Figure 11 – Example solar-powered pump performance curves for a centrifugal pump.

**7. DESIGN PROCESS**

The following twelve steps can be used in the design process for a PV-powered water pump system. These steps will help you ensure that the system functions properly and that water is supplied for the operation in the amounts and at the locations required.

**7.0 Step 1 – Water Requirement**

The first step in designing a solar-powered water pump system is to determine the overall water requirement for the operation. This can be done in part by using the average water requirement values for various crops and livestock that are listed in Table 4, below.

**Table 4 – Typical Water Use Requirements**

Animal or Crop	Approximate Water Usage (gal/day) <sup>1</sup>	
	Western Oregon	Eastern Oregon
Milking Cow	20-25	20-25
Dry Cow	10-15	15-20
Calf	6-10	10-15
Cow-Calf Pair	15-20	20-25
Beef Cattle	8-12	20-25
Sheep or Goat	3-5	5-8
Horse	12	20-25
Swine, Finishing	3-5	3-5
Swine, Nursery	1	1
Swine, Sow and Litter	8	8
Swine, Gestating Sow	6	6
Elk	4	7
Deer	2-3	3
100 Chickens	9	9
100 Turkeys	15	15
Irrigated Crops	Use local crop consumptive use data.	
Young Trees (in dry weather)	15	15

<sup>1</sup> General values adapted from “Midwest Plan Service Structures and Environment Handbook,” adjusted upward for drier eastern Oregon climate.

Local conditions should be taken into consideration. Also note that the operation’s water requirement will vary throughout the year. (Examples of how to calculate the water requirement for a solar-powered water pump system are given in Design Examples 1 and 2 in Appendix C.)

**7.1 Step 2 – Water Source**

The configuration of the water system will be defined primarily by the type of water source used, as well as by the local topography and the location(s) of the delivery point(s). The water source may be either subsurface (a well) or surface (a pond, stream, or spring).

If the water source is a well, the following items will need to be determined:

- The static water level,
- The pumping rate and associated drawdown (along with any seasonal variation), and
- The water quality.

Information on water levels and well production can be obtained from the well log. (A sample well log is provided in Appendix H and is used in Design Example 2 in Appendix C.)

The drawdown value obtained from the well log should be used to determine the production potential of the well to ensure that the well will be able to supply the operation’s estimated water needs. If the well log indicates an excessive drawdown during the given testing time, the well may not have the capacity to meet the water demands of the project. If the capacity of the well is in question, a complete well test should be performed and the drawdown levels measured for different flow rates.

In addition, the drawdown level should be used when determining the pumping lift and TDH during pumping.

If a new well is to be drilled for the project, information from well logs of existing, nearby wells can provide valuable information about the subsurface hydrology in the area and the potential yield of the proposed well. Records of well logs are available online from the Oregon Water Resources Department (WRD).

The expected pumping levels should be determined in areas where water table fluctuations occur throughout the year. In such areas, a well may even run dry at certain times of the year. An alternate water source should be located if there is a potential for an existing well to run dry during critical watering times.

For most wells, water quality is not an issue if the water is not used for human consumption. However, it is a good practice to obtain a water quality test if there is a potential for fecal coliform contamination, high nitrates or salinity, organic contaminants, and/or the presence of heavy metals, which may be the case for wells located in unique geological features, such as volcanic terrain.

Questions or comments regarding well drilling and/or water quality testing should be directed to the NRCS State Geologist.

For surface water sources, such as a stream, pond, or spring, the following need to be determined, taking seasonal variations into account:

- The water availability,
- The pumping levels, and
- The water quality, including the presence of silt and organic debris.

With a surface source, the water availability and water level can vary seasonally. In particular, the amount and quality of the water may be low during the summer, when it is needed most.

Additionally, when a surface water source is used, proper screening of the pump intake is necessary to ensure that debris and sediment from the surface water body are not pumped into the system. If the water source contains anadromous salmonid species of fish, proper screening of the pump intake is required to meet Oregon Department of Fish and Wildlife (ODFW) fish screen criteria. (A copy of the general criteria is located in Appendix I. Contact the ODFW representative for your area for local screening requirements.)

## 7.2 Step 3 – System Layout

The third step in the system development process is to determine the layout of the entire system, including the **locations** and **elevations** of the following components:

- Water source
- Pump
- PV panels
- Storage tanks
- Points of use (i.e. water troughs)
- Pipeline routes

An example of a proposed system layout is provided in Figures 12 and 13, below.

**It is also important to consider potential vandalism and theft when locating PV panels and pump systems.** Unfortunately, since most solar panel systems are located in remote areas on open landscapes, the risk of vandalism and/or theft can be significant. If possible, panels, tanks, and controllers should be located away from roads and public access, as well as where features in the landscape (rolling hills, escarpments, wind blocks, etc.) can provide a maximum of shielding from public view. The use of trees, bushes, or other types of vegetation for shielding is acceptable. However, care should be taken to situate the panels far enough to the south and west of tall trees and other types of vegetation to reduce the potential for their obstruction by shadows during peak solar insolation hours.

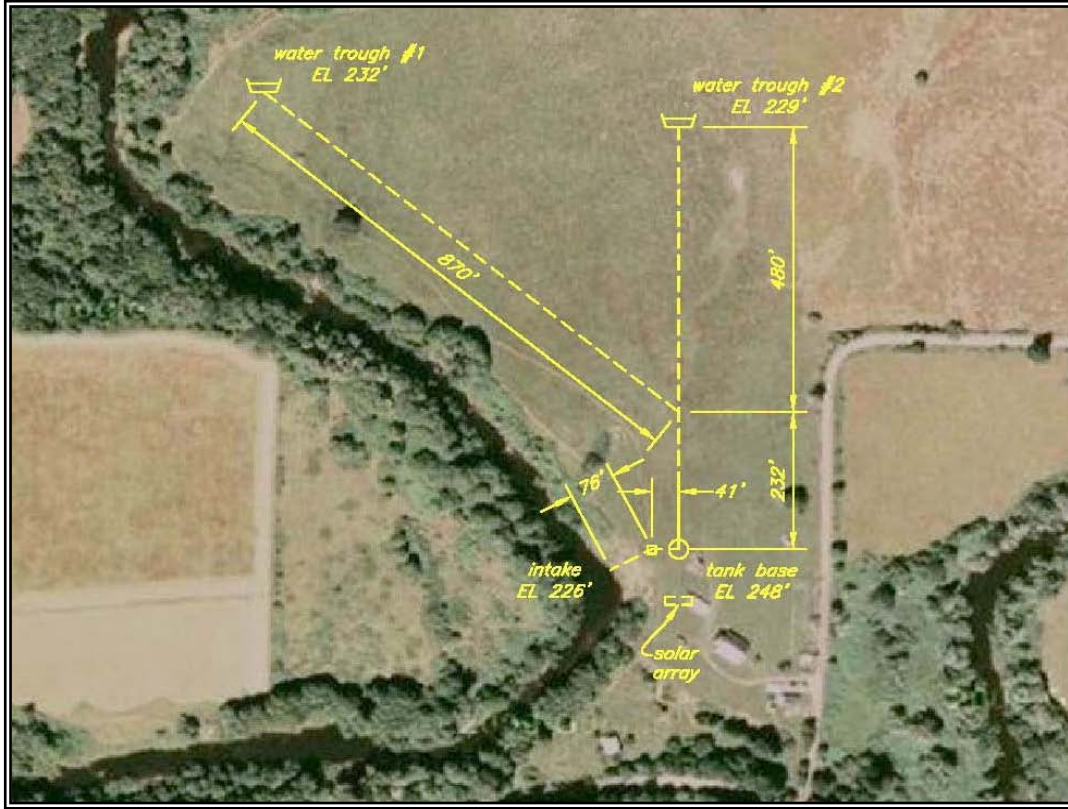

Figure 12 – A plan of an example watering system with a storage tank and PV array.

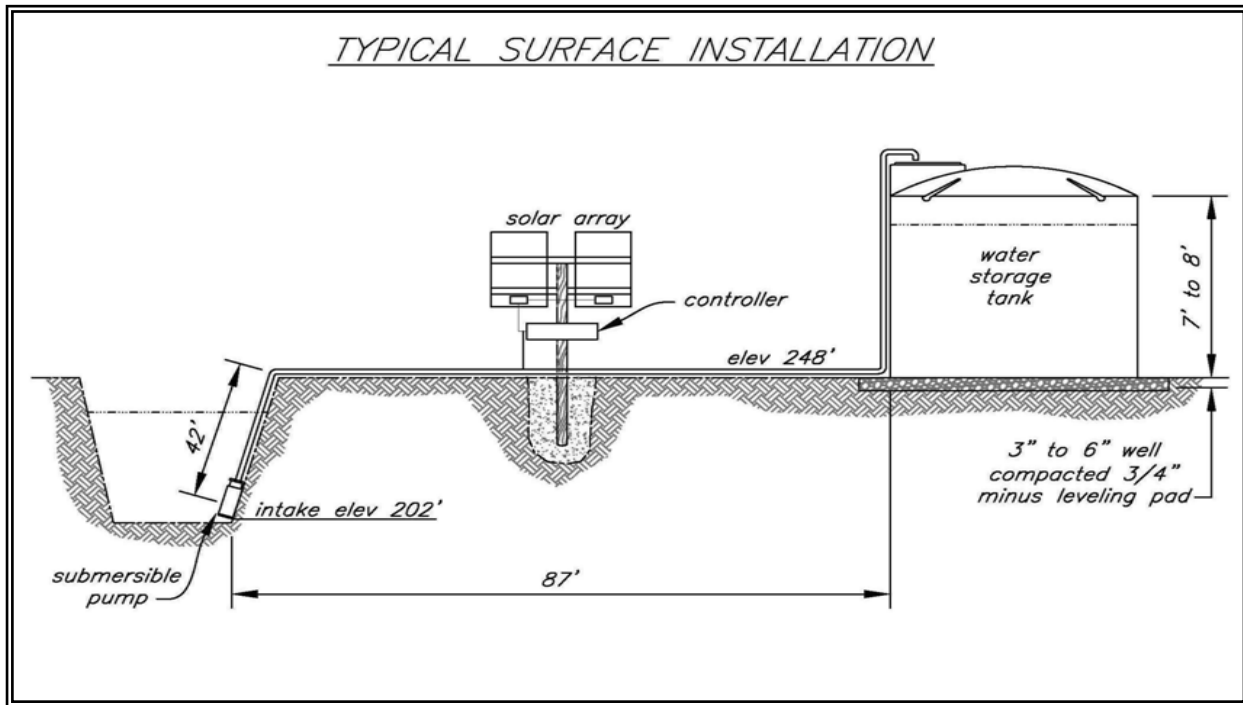

Figure 13 – Elements of a typical installation supplied by a surface water source.



In addition, secure fencing is essential to protect a PV-powered system. Secure fencing provides added protection against vandalism and theft, as well as against inadvertent damage from wandering wildlife or livestock.

### **7.3 Step 4 – Water Storage**

A water storage tank is normally an essential element in an economically viable solar-powered water pump system. A tank can be used to store enough water during peak energy production to meet water needs in the event of cloudy weather or maintenance issues with the power system. Ideally, the tank should be sized to store at least a three-day water supply. Multiple tanks may be required if a very large volume of water is to be stored.

The area where the tank is to be placed must be stripped of all organic material, debris, roots, and sharp objects, such as rocks. The ground should then be leveled. Six inches of well-compacted  $\frac{3}{4}$ -inch leveling rock underlain by a geotextile fabric should be provided as a base for the water tank. If an elevated platform or stand is required to provide adequate gravity-induced pressure for the water delivery system to operate, the platform or stand will need to be evaluated by a qualified engineer.

An above-ground tank should be constructed out of structurally sound, UV-resistant material to maximize its lifespan. If it will be used in areas where freezing temperatures are encountered, care should be taken to frost-proof the entire water delivery system. Tanks and pipes should be drained prior to the first freeze, and pipes should be buried below the frost line for added protection.

A buried tank is naturally shielded from UV light, and it provides protection from frost and vandalism. When using a buried tank, however, adequate drainage must be provided around the tank. In addition, its design must be analyzed for floatation to ensure that the tank will not become buoyant.

### **7.4 Step 5 – Solar Insolation and PV Panel Location**

Appropriate data should be used to determine the amount of solar insolation (peak sun hours) available at the site. Appropriate data on solar insolation values for different locations in Oregon may be obtained from the tables in Appendix D or from a solar insolation program, such as the PVWATTS Beta Viewer that was developed by the NREL. (A brief introduction to the PVWATTS Beta Viewer is provided in Appendix E.)

An on-site investigation is recommended for sites where solar insolation data are lacking or questionable. The investigation should be conducted by a qualified specialist and include data verifying the actual solar insolation at the site.

In order to maximize the solar-powered system's energy production, the panels should be south facing with no significant shading in their vicinity in order to achieve full sun exposure. However, partial shading (e.g., shadows from tall trees) in the distance during the early morning or late afternoon may be unavoidable. The effects of any shading present should be considered when determining the amount of available solar energy. Also consider the potential effects that the slope and aspect of future shading due to continued tree growth may have.

The solar array should be placed as close to the pump as possible to minimize the electric wire length (and thus any energy loss), as well as installation costs.

### **7.5 Step 6 – Design Flow Rate for the Pump**

The design flow rate for the pump is calculated by dividing the daily water needs of the operation by the number of peak sun hours per day (determined in Step 5). For example, for a daily water requirement of 1,310 gallons/day



and a solar insolation value of 7.2 kWh/m<sup>2</sup>/day, or 7.2 hr/day:

$$\begin{aligned} \text{Flow} &= \frac{1,310 \text{ gal/day}}{7.2 \text{ hr/day}} \\ &= 181 \text{ gal/hr} \\ &\sim 3 \text{ gal/min} \end{aligned}$$

*Equation 3*

**7.6 Step 7 – Total Dynamic Head (TDH) for the Pump**

As described in Appendix K, the TDH for a pump is the sum of the vertical lift, pressure head, and friction loss. Friction losses apply only to the piping and appurtenances between the point of intake (inlet) and the point of storage (i.e. the storage tank or pressure tank). Flow from the storage tank to the point of use (i.e. the trough) is typically gravity fed. Therefore, friction losses between the storage tank and the point of use are independent from the pump and do not need to be accounted for when sizing the pump.

**7.7 Step 8 – Pump Selection and Associated Power Requirement**

The pump should be selected using pump performance curves, such as those shown in Figures 10 and 11 (page 13), to ensure that the pump can deliver the required flow (Step 6) against the known TDH (Step 7). The peak power requirement for the pump can be determined from these curves for a given flow rate and TDH (pumping head) to help make the appropriate pump selection, as well as the appropriate PV panel selection (Step 9).

The system designer may need to research the different solar-powered pumps available on the market at the time of the system development as solar-powered pumps are a dynamic and growing field that changes rapidly. The

manufacturer’s specification sheet contains the necessary information to select the correct pump. Note, however, that the type of information provided may be subject to change as solar technology improves and evolves.

Sources for additional information regarding solar products can be found in Appendix B: Additional Resources.

**7.8 Step 9 – PV Panel Selection and Array Layout**

Once the peak power requirement (Step 8) for the selected pump is known, this value can be used to select the solar panel or array of panels required to supply that power.

When multiple panels are required, they must be wired in series, parallel, or a combination of series-parallel to meet both the voltage and amperage requirements of the pump. (See Appendix J for examples of wiring panels in series, parallel, and a combination of series-parallel.) The power output of the individual panels can be added together to determine the total power they produce.

**7.9 Step 10 – PV Array Mounting and Foundation Requirements**

Standard details for a PV panel embedded post mount that meets the design criteria listed in Section 4.1 are provided in Appendix F. Designs that exceed the criteria listed in Section 4.1 must be constructed by a qualified engineer.

Hardware for mounting panels to a post is normally provided by the supplier. If no supplier mount is provided, contact a qualified engineer for design details. Also note that all panel mount hardware must meet Oregon Construction Specification 68 requirements.

As noted in Section 4, panel mount posts other than the standard posts and associated embedment shown in Appendix F require a documented engineering design.

If a panel or array of panels is to be mounted on an existing structure, that structure must first be analyzed to ensure that it has the structural integrity necessary to withstand all local wind, snow, and ice conditions once the panel(s) are mounted.

#### **7.10 Step 11 – Water Flow Rates and Delivery Point Pressure**

The entire system, including the PV panels, pump, pipe, and any storage tanks, must be analyzed to ensure that the design flow rates can be delivered to the delivery point(s) at the required pressure(s) in order to properly operate the valves (e.g., a float valve).

#### **7.11 Step 12 – Summary Description of the System**

The designer should provide a descriptive summary of the completed system to the landowner/contractor that includes the following information:

- All system components and their specifications.
- System operating characteristics, such as required voltages, amperages, wattages, etc.

- Special considerations required in the system design, including environmental factors.

### **8. ADDITIONAL CONSIDERATIONS**

This technical note has reviewed the many different elements that should be considered in the design of a solar-powered water pump system. Design examples are provided in Appendix C, which will walk the designer through two typical design scenarios. In addition, three sets of standard drawings are provided in Appendix F to assist the designer in the development of a design package. However, since each system will have its own unique set of design constraints, this technical note is not intended as a standalone document. Rather, its intent is to provide a starting point for the design process.

In addition to using this technical note, the designer is encouraged to perform research using the recommended references located in Appendix B: Additional Resources to collect further information on solar-powered water pump systems.

## APPENDIX A: References

---

- Brian D. Vick and R. Nolan Clark. Determining the Optimum Solar Water Pumping System for Domestic Use, Livestock Watering or Irrigation. 2009. Proceedings of ASES National Solar Conference. Buffalo, NY.
- Lance Brown. B.C. Livestock Watering Handbook. 2006. British Columbia Ministry of Agriculture and Lands. Abbotsford, B.C.
- Christopher W. Sinton, Roy Butler, and Richard Winnett. Guide to Solar Powered Water Pumping Systems in New York State. New York State Energy Research and Development Authority. Albany, NY.
- Michael J. Buschermohle and Robert T. Burns. Solar-Powered Livestock Watering Systems. PB 1640. Agricultural Extension Service, University of Tennessee. <http://utextension.tennessee.edu/publications/Documents/pb1640/pdf>.
- Midwest Plan Service Structures and Environment Handbook. 1987. Iowa State University. Ames, Iowa.
- Solar Radiation Basics. 2002. University of Oregon Solar Radiation Monitoring Lab. [www.solardat.uoregon.edu](http://www.solardat.uoregon.edu).
- Renewable Energy Primer-Solar. 2003. USDA-NRCS West National Technical Center. Portland, Oregon.
- Notes from Corrosion Control Seminar. 2005. U.S.Army Corps of Engineer Professional Development Support Center. Huntsville, AL.
- Mike Morris and Vicki Lynne. Solar-powered Livestock Watering Systems. 2002. Appropriate Technology Transfer for Rural Areas. [www.attra.ncat.org](http://www.attra.ncat.org).
- Montana Stockwater Pipeline Manual. 1992 (revised 2004). USDA NRCS, Bozeman Montana. [ftp://ftp-fc.sc.egov.usda.gov/MT/www/eng/engineering\\_documents/engineering\\_manuals/MSPM.pdf](ftp://ftp-fc.sc.egov.usda.gov/MT/www/eng/engineering_documents/engineering_manuals/MSPM.pdf).
- The Montana Agsolar Project – Expanding the Agricultural Uses of Solar Energy in Montana. December 2000. National Center for Appropriate Technology. Butte, Montana.

## APPENDIX B: Additional Resources

---

Additional information on solar-powered water pump systems can be found by doing an internet search for the following:

- National Renewable Energy Laboratory
- US Department of Energy, Energy Efficiency & Renewable Energy
- USDA NRCS Energy Self Assessment
- National Sustainable Agriculture Information Service
- Energy Trust of Oregon
- Database of State Incentives for Renewables and Efficiency
- Renewable Energy Site for Do-It-Yourselfers
- American Solar Energy Society – Directory/Tools/Costs
- Homepower Magazine – Dealers/Installers
- Real Good Solar Products
- Solar System Rating and Certification

## APPENDIX C: Design Examples

This appendix contains two examples that demonstrate how to design a solar-powered water pump system. The first scenario utilizes a surface water source (a stream) while the second utilizes a subsurface water source (a well).

The intent of these two typical design scenarios is to walk you through the basic design process. These examples are not meant to address all the elements needed for the design and implementation of all solar-powered water pump system but merely to demonstrate the basic concepts. Each system will have its own unique set of design considerations and constraints, which will need to be addressed accordingly.

### DESIGN EXAMPLE 1: Solar-Powered Water Pump System Using Surface Water (a Stream) as a Water Source

**Determine:**

To design a solar-powered water pump system for this design example, which consists of a mid-size organic sheep operation in Cottage Grove, Oregon, it is necessary to determine the size of the system needed, including the pump, PV panels, appropriate mounting structure, pipes, tank size, etc.

**Given:**

- The landowner runs 216 sheep on 40 acres of pasture land.
- The landowner intends to draw water from a nearby stream from May through September, when the animals are let out to pasture.

- The landowner has documented water rights to the stream.
- The stream is fish bearing.
- The intake line is located 42 ft below the base of the tank and several feet below average for capturing water during low flow conditions in the summer months. (Note that when lifting water higher than 12 to 15 ft, the use of a submersible pump instead of a surface-mount pump is recommended to avoid potential suction lift problems.)
- The landowner lives nearby and is on the site daily for routine maintenance but would like a tank sized for a minimum of three days worth of water storage in the event of extended cloudy weather or maintenance issues that prevent the pump from operating.
- The landowner intends to gravity feed two watering troughs located 1,118 ft and 712 ft from the proposed storage tank. Two 500-gallon troughs are to be used. Each trough will be equipped with a float valve that requires 2 psi to operate properly.

**Analysis:**

***Step 1. Water Requirement***

To determine the operation's water needs, use Table 4 (page 14) to calculate the total water requirement for the sheep, as shown below:

$216 \text{ sheep} \times 5 \text{ gallons/day/animal} = 1,080 \text{ gallons/day}$
---

***Equation C1***

**Step 2. Water Source**

The water source for the planned system is a small stream with steep banks. The stream flows year round with sufficient flow to supply the planned system, and the water quality is suitable for livestock. However, adequate screening must be provided per ODFW requirements for the pump intake since the stream is known to contain anadromous salmonid fish species during certain periods of the year.

**Step 3. System Layout**

The next step is to determine the layout of the proposed system. You will need to identify all necessary distances and elevations for the intake point, pump, PV panels, water tank, and water troughs, as shown in Figure C1, below. For this example, based on the site-specific data provided in this aerial view, the site has good

south-facing exposure and appears well suited for solar power. Flow from the tank to the water troughs will be gravity fed. Based on the given elevations, the natural layout of the site appears to provide an adequate elevation difference between the tank and the water troughs to operate the tank float valves in the water troughs. (See the calculations provided in Step 11 confirming this fact.) In addition, the tank, pump, and PV panels can all be located in close proximity to one other in order to minimize electric power and pipeline friction losses.

Figure C2, on the following page, is a profile of the proposed layout showing all the pertinent information needed to design the pump and PV panels. (Since the landowner intends to gravity feed the water troughs from the tank, the locations and elevations of the troughs do not factor into the design of the pump and panels.)

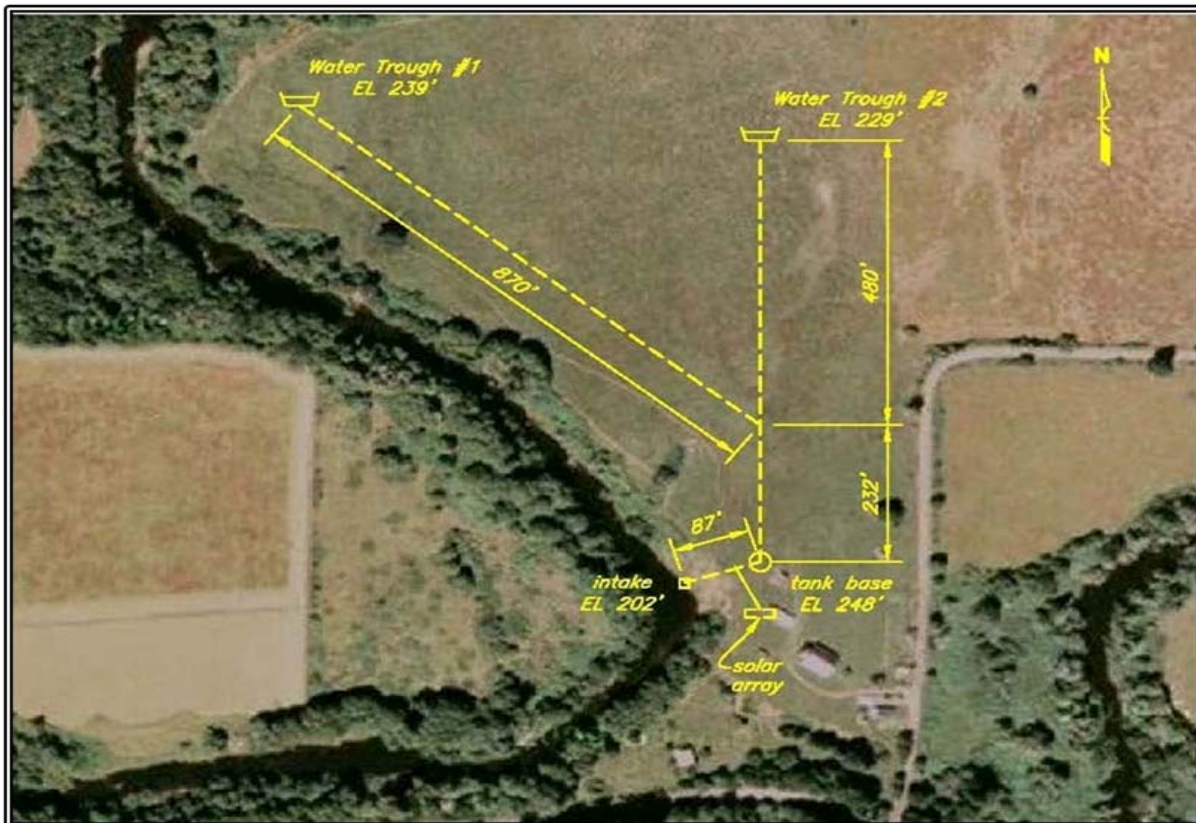

**Figure C1** - Layout of a proposed stock water system for Design Example 1.

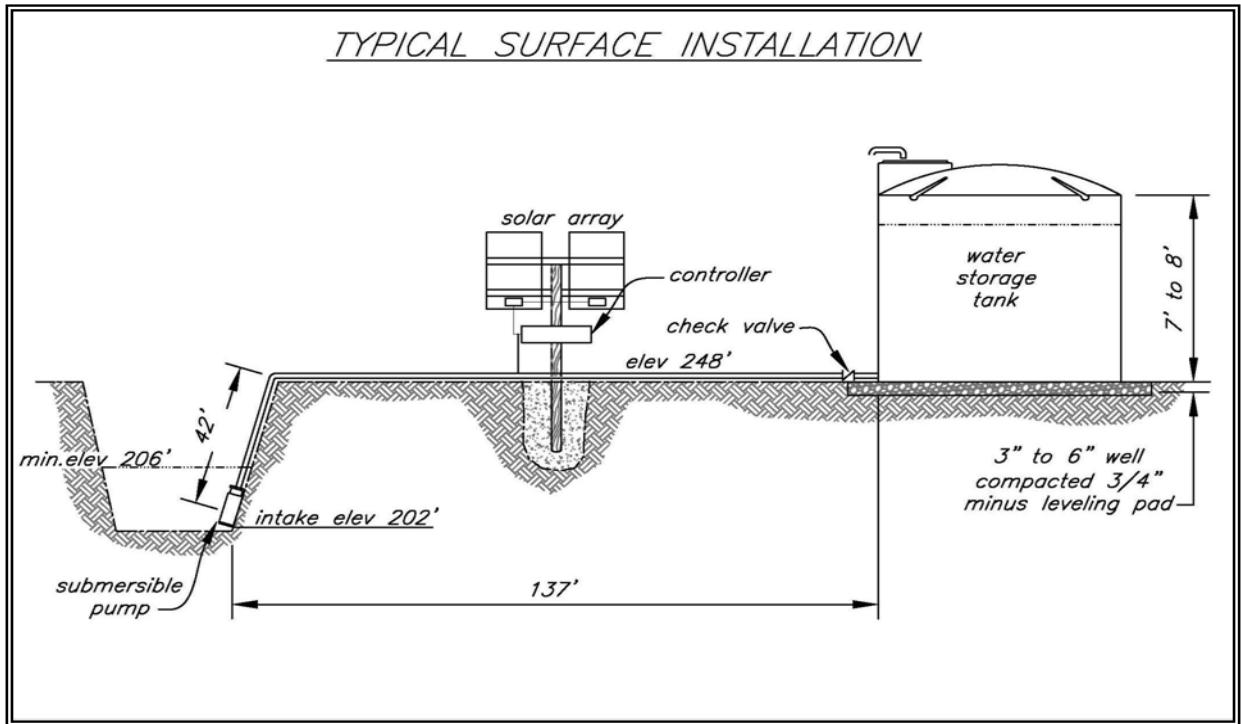

**Step 4. Water Storage**

The system’s total water storage capacity should be sufficient for a minimum of three days water use. This minimum storage capacity is calculated below using the water requirement derived in Step 1.

$1,080 \text{ gallons/day} \times 3 \text{ days} = 3,240 \text{ gallons}$
---

Equation A 2

Two 500-gallon water troughs are included in the system, providing a total storage capacity of 1,000 gallons (2 x 500 = 1,000). Therefore, the storage tank must be sized to hold a minimum of 2,240 gallons (3,240 – 1,000 = 2,240). Based on information from different distributors, a 2,500-gallon water tank is a readily available size. The tank is 92 inches in diameter and 95 inches tall. As a safety precaution, it is recommended that the tank and troughs be filled prior to use to ensure that the system has adequate water storage.

In order to provide adequate drainage, a firm foundation that can support the 20,785 lb weight of the completely full tank (2,500 gallons x 8.314 lb/gallon = 20,785 lb) is required. In addition, to minimize the potential for settlement, the use of a minimum 3-inch thick leveling pad of well compacted ¾-inch drain rock underlain by geotextile fabric is recommended for the foundation. The 3-inch thick leveling pad should extend approximately 1 ft beyond the footprint of the tank.

**Step 5. Solar Insolation and PV Panel Location**

The closest solar insolation values to those for Cottage Grove, Oregon, that are contained in Appendix D are for Eugene, Oregon, based on the proximity of the two locations. Therefore, the tabulated solar insolation values for Eugene will be used for this design. The average solar hours for flat-plate collectors facing south at a fixed tilt of 29° (44° – 15° = 29° degrees from horizontal) during the summer months in Eugene are listed in Table C1, below.

Eugene, OR 29° Tilt	Average kWh/m <sup>2</sup> /day or peak sun hours per day	May	Jun	Jul	Aug	Sep
		5.6	6.0	6.7	6.3	5.4

Using the tabulated values above, there are several different ways to assess the number of peak sun hours to use when designing the system. The designer may elect to use the peak sun hours for the month that generates the most as that month would most likely correlate with the month in which the operation's water need is greatest. Or the designer may elect to use the peak sun hours for the month that generates the least number of peak sun hours for added insurance. For the purposes of this example, the average of all five months will be used since the values are relatively similar over the May through September period. This amount can be calculated as follows:

$$\frac{(5.6 + 6.0 + 6.7 + 6.3 + 5.4)}{5} = 6.0 \text{ hours}$$

**Equation C3**

The decision of which approach to use to determine the peak sun hours to base the system design on is up to the discretion of the designer and should be based on good engineering judgment.

**Step 6. Design Flow Rate for the Pump**

The pump's design flow rate is based on the operation's estimated daily water needs (Step 1) divided by the number of peak sun hours per day (Step 5), as shown below.

$$\frac{1,080 \text{ gallons}}{(6.0 \text{ peak sun hours} \times 60 \text{ minutes/hour})} = 3.0 \text{ gpm}$$

**Equation C4**

**Step 7. Total Dynamic Head (TDH) for the Pump**

To determine the pump's TDH, use the following equation:

$$TDH = \text{Vertical Lift} + \text{Pressure Head} + \text{Friction Losses}$$

**Equation C5**

**Vertical lift** is the vertical distance between the water surface at the intake point (the stream's water surface) and the water surface at the delivery point (the tank's water surface). In this example:

$$\text{Vertical Lift} = 248 \text{ ft} + 8 \text{ ft} - 206 \text{ ft} = 50 \text{ ft}$$

**Equation C6**

**Pressure head** is the pressure at the delivery point in the tank. For this example, there is no pressure at the delivery point (the water surface in the tank), so:

$$\text{Pressure Head} = 0 \text{ ft}$$

**Equation C7**

**Friction loss** is the loss of pressure due to the friction of the water as it flows through the pipe. Friction loss is determined by four factors: the pipe size (inside diameter), the flow rate, the length of the pipe, and the pipe's roughness. Appendix G contains a list of calculated friction losses for different pipe sizes and flow rates for Schedule 40 PVC pipe.

Due to the relatively close proximity of the intake point and the storage tank in the given



system layout, the total friction losses in the pipeline are minimal. As such, a less expensive, smaller diameter pipe is selected.

Approximately 137 ft of ¾-inch diameter PVC pipe will be used to convey water from the source to the tank. From Appendix G, the friction loss for ¾-inch pipe conveying 3.0 gpm (Step 6) is approximately 2.17 feet of head loss per 100 ft of pipe. Therefore, the total estimated friction loss for 137 ft of pipe is 2.97 ft (137 ft ÷ 100 ft of pipe x 2.17 ft of head loss/100 ft = 2.97 ft). Minor losses through elbows and valves are estimated to be 1.8 ft, for a total friction loss of 4.77 ft (2.97 + 1.8 = 4.77). (More details on hydraulic analysis are contained in the NRCS National Engineering Handbook, Part 634.)

Therefore, the TDH for the proposed system is calculated as shown below.

$$\begin{aligned}
 TDH &= 50 \text{ ft} + 0 \text{ ft} + 4.77 \text{ ft} \\
 &= 54.77 \text{ ft} \rightarrow \text{use } 55 \text{ ft}
 \end{aligned}$$

Equation C8

**Step 8. Pump Selection and Associated Power Requirement**

The pump can be selected by comparing the design flow rate and TDH calculated in Steps 6 and 7 with the information from the manufacturer’s pump curves. The pump curves in Figure C3 (duplicated from Figure 10), below, are used for this scenario.

The first step for this example is to locate the design flow rate of 3.0 gpm on the y-axis of the pump curve diagram and draw a horizontal line across the chart through this point, as shown. Next, locate where this line intersects the curve representing a TDH of 55 ft (60 ft being the closest curve in the case of Figure C3). From this point of intersection, draw a vertical line to the bottom of the graph. The point where the vertical line crosses the x-axis shows the peak power requirement for the pump. As shown, based on a calculated flow rate of 3.0 gpm and a TDH of 55 ft (rounded up to 60 ft), a minimum input of 160 Watts of peak power is required.

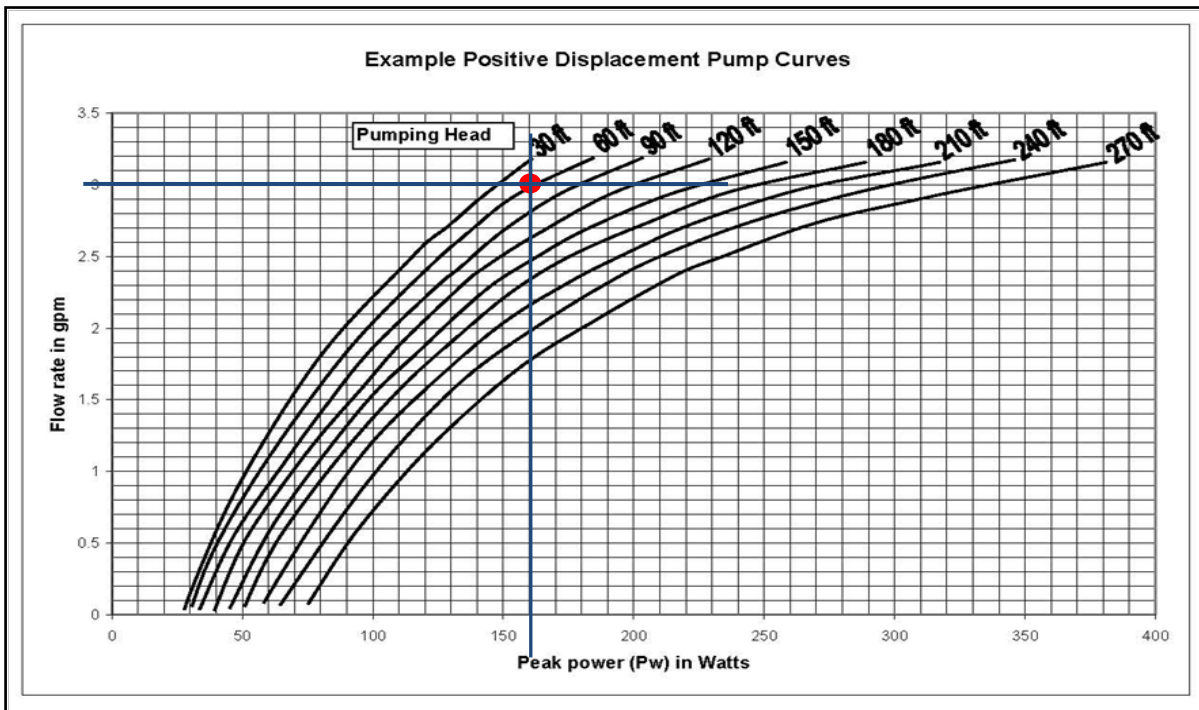

Figure C3 – Pump curves used for Design Example 1.

(The minimum operating voltage for the pump to run efficiently is specified as 60 volts by the manufacturer.)

**Step 9. PV Panel Selection and Array Layout**

The PV panels selected for this system must be able to provide the minimum energy requirement to run the pump. As determined in Step 8, the minimum power needed is 160 Watts. However, the panels must also have additional capacity to account for any potential reduction in power due high heat, dust, age, etc. Many PV manufacturers recommend increasing the minimum peak power value by 25% to account for these environmental factors. Therefore, the PV panels will be sized to provide a minimum output of 200 Watts (1.25 x 160 = 200 W).

A PV panel is selected that has the electrical characteristics shown in Table 3 (page 6): a peak power output of 117 W at 35.5 V and 3.3 A. Therefore, two panels are required to meet the pump’s power requirement. They will be wired in series to provide the necessary voltage for the pump. (See Appendix J for panel wiring information.)

**Step 10. PV Array Mounting and Foundation Requirements**

Since site conditions permit (i.e. the depth of embedment is not limited by shallow bedrock) and the site is located in an area where the recommended design wind speed tolerance is 85 mph or less, the standard details for mounting structure embedded posts listed in Appendix F may be used. (If the panels were going to be located in a high wind area, a more detailed analysis of the mounting structure would be needed.)

**Step 11. Water Flow Rates and Delivery Point Pressure**

As noted in the given information for this example, the float valve used for each trough

requires a minimum of 2 psi (equal to 4.6 ft of head) to be activated. To ensure there is adequate pressure to operate the float valve in each water trough, determine the pressure head available at the trough for a flow rate of 1.0 gpm in the pipe (which is sufficient to supply the daily water requirement for the trough), as shown in the following equation.

Water Trough #1

$$\begin{aligned} & (Elev + Pressure Head)_{Tank} \\ &= (Elev + Pressure Head)_{Trough} + Friction Loss \\ & \qquad (248 \text{ ft} + 0.5 \text{ ft})_{Tank} \\ &= (239 \text{ ft} + Pressure Head)_{Trough} + Friction Loss \\ & \text{Tank Pressure Head} = 0.5 \text{ ft to conservatively} \\ & \qquad \text{assume the tank is near empty.} \\ & \text{Friction Loss (for } \frac{3}{4}\text{-inch pipe @ 1 gpm)} \\ &= \frac{0.28 \text{ ft}}{100 \text{ ft of pipe}} \times \text{length of } \frac{3}{4}\text{-inch pipe} \\ &= \frac{0.28 \text{ ft}}{100 \text{ ft of pipe}} \times \frac{870 \text{ ft} + 232 \text{ ft}}{100 \text{ ft}} \\ &= 3.86 \text{ ft} \\ & \text{Pressure Head}_{Trough} \\ &= 248 \text{ ft} + 0.5 \text{ ft} - 239 \text{ ft} - 3.86 \text{ ft} \\ &= 5.64 \text{ ft} \\ & \text{5.64 ft is greater than the minimum} \\ & \qquad \text{requirement of 4.6 ft.} \end{aligned}$$

**Equation C9**

Since the pressure at the trough is greater than the required pressure needed to operate the float valve, the delivery system to this trough is acceptable. If additional pressure were needed, however, increasing the delivery pipe size to a 1-inch or 1½-inch diameter pipe would significantly reduce friction losses, thereby increasing the pressure available at the trough. (Additional information on flow rates and pipe

sizing can be obtained from the Montana Stockwater Pipeline Manual.)

Water Trough #2

The pressure at Water Trough #2 can be determined through observation. Since it is lower in elevation and closer to the water tank than Water Trough #1, thereby resulting in less friction loss, its pressure is acceptable.

**Step 12. Summary Description of the System**

Since the water source is a fish-bearing stream, the intake pipe will need to be screened, as per ODFW’s fish screen criteria. (A copy of the state criteria for Oregon is located in Appendix I. Contact ODFW representatives in your area for local screening requirements.)

The system information can be recorded as follows (per Step 9):

Power Required  
(Performance Curve): 160 Watts

Solar Panel Rating: 234 Watts  
71 Volts  
3.3 Amps

The panel information for the system can be described as:

Number of Panels: 2 wired in series

Panel Dimensions: Length = 60 inches  
Width = 26 inches

Recommended Safety Switches: 1. Run-dry switch so the pump does not run dry.  
2. Tank float switch to stop the pump when the storage tank is full.

This information can be summarized on a copy of the drawings located in Appendix F, which can be provided as part of the design package.

**DESIGN EXAMPLE 2: Solar-Powered Water Pump System Using Subsurface Water (a Well) as a Water Source**

Determine:

To design a solar-powered water pump system for this design example, which consists of a beef operation in Crane, Oregon, it is necessary to determine the size of the system needed, including the pump, PV panels, appropriate mounting structure, pipes, tank, etc.

Given:

- A beef operation in Harney County near Crane, Oregon, where the landowner runs 250 head of beef on 1,500 acres. He rotates the herd every two to three weeks between three 500-acre pastures.
- A herd of elk (approximately 30) routinely take up residence in the pastures.
- A water supply is needed during the summer grazing season.
- The landowner is requesting a minimum of three days worth of water storage using either one large or two smaller water tanks.
- The landowner intends to gravity feed three water troughs. The troughs hold 700 gallons each. They are equipped with float valves that require a minimum pressure of 2 psi to operate properly.
- A well log (Appendix H) has been obtained from a recently constructed well located a half mile away. It contains the following pertinent information:
  - Static water level = 106 ft
  - Yield = 30 gal/min
  - Drawdown = 9 ft after 2 hours of testing
  - Total well depth = 269 ft
  - Depth of pump below ground = 181 ft

**Analysis:**

**Step 1. Water Requirement**

The daily water requirement for the animals present on the property is determined as follows using the quantities listed in Table 4 (page 14):

$250 \text{ beef cattle} \times 15 \text{ gallons/animal/day}$ $= 3,750 \text{ gallons/day}$ $30 \text{ elk} \times 7 \text{ gallons/animal/day}$ $= 210 \text{ gallons/day}$ $\text{Total daily water requirement:}$ $= 3,750 + 210 \text{ gallons}$ $= 3,960 \text{ gallons}$
---

**Equation C10**

**Step 2. Water Source**

The water source will be a new well that will be drilled. It is anticipated that the well will have characteristics similar to those given for the nearby, existing well referenced previously.

**Step 3. System Layout**

Based on the site-specific data collected, the site has good south-facing exposure and appears well suited for solar power, as shown in Figure C4, on the following page. In addition, based on the given elevations, the natural layout of the site appears to provide an adequate elevation difference between the tank and water troughs to operate the tank float valves in the water troughs. (See the calculations provided in Step 11 confirming this fact.)

Figure C5, on the following page, is a profile of the proposed layout showing all the pertinent information needed to design the system. As

shown, the pump and PV panels are located 3,575 ft from the main storage tank. The troughs are located at varying distances from the tank. (Since the landowner intends to gravity feed the water troughs from the tank, the locations and elevations of the troughs do not factor into the design of the pump and panels.)

**Step 4. Water Storage**

The anticipated volume of water storage that the operation will need, which should be sufficient for a minimum of three days of water use, can be calculated as follows using the water requirement derived in Step 1:

$3,960 \text{ gallons/day} \times 3 \text{ days}$ $= 11,880 \text{ gallons}$
--

**Equation C11**

Three 700-gallon water troughs are included in the system, providing a total storage capacity of 2,100 gallons (3 x 700 gallons = 2,100 gallons). Therefore, a tank sized to hold a minimum of 9,780 gallons is needed (11,880 – 2,100 = 9,780). A standard tank size that is commercially available is 10,000 gallons. The tank is 141 inches in diameter and 160 inches tall. As a safety precaution, it is recommended that the tank and troughs be filled prior to use to ensure that the system has adequate water storage.

Due to the relatively large footprint of the tank and its 83,140 lb weight when full (10,000 gallons x 8.314 lb/gallon = 83,140 lb), it is recommended that a minimum 3-inch thick leveling pad of well compacted ¾-inch drain rock be provided for the foundation. The leveling pad should extend approximately 1 ft past the footprint of the tank.

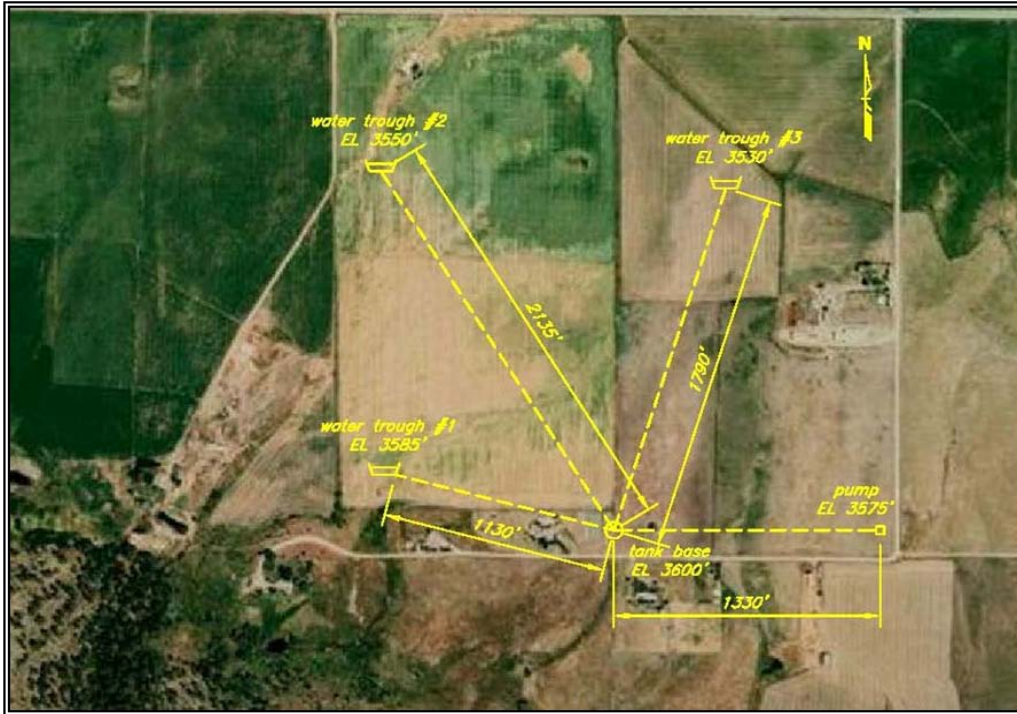

Figure C4 - Layout of proposed stock water system for Design Example #2.

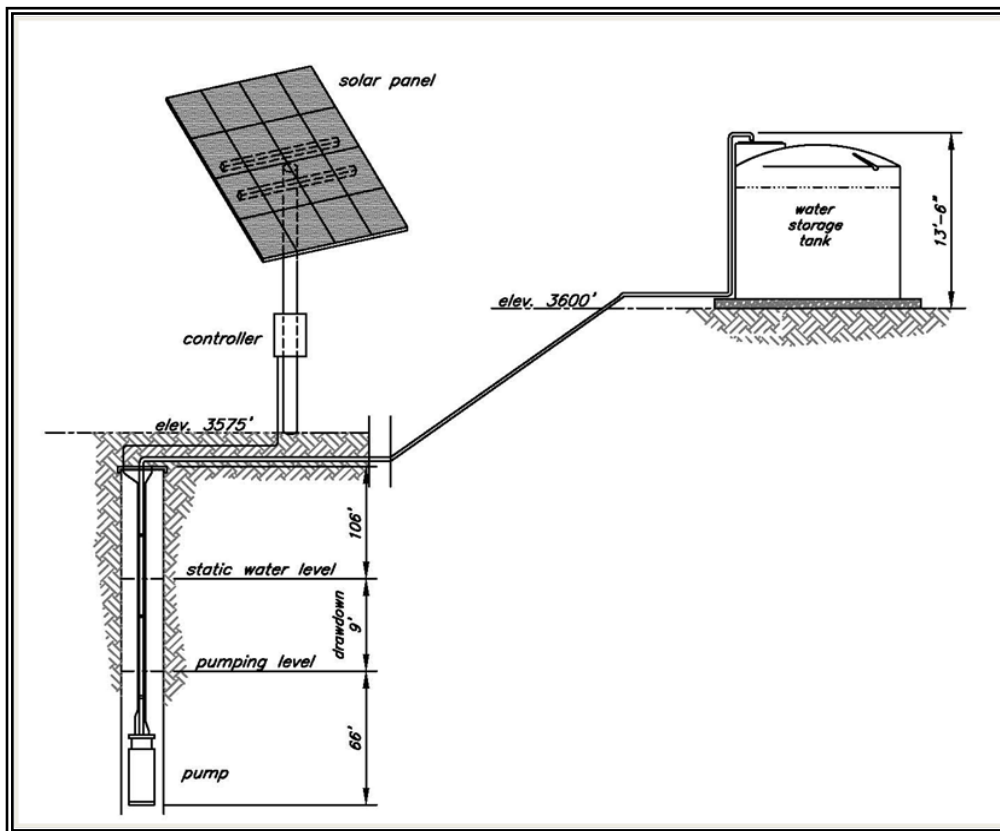

Figure C5 - Pump pipeline profile for Design Example #2.

Burns, OR 29° Tilt	Average kWh/m <sup>2</sup> /day or peak sun hours per day	May	Jun	Jul	Aug	Sep
		6.5	6.9	7.5	7.3	6.3

**Step 5. Solar Insolation and PV Panel Location**

The closest solar insolation values to those for Crane, Oregon, that are contained in Appendix D are for Burns, Oregon, based on the proximity of the two locations. Therefore, the solar insolation values for Burns for flat-plate collectors facing south at a fixed tilt of 29° (44° latitude – 15° = 29°) during the summer months will be used for this example. These values are shown in Table C2, above.

Using the tabulated values above, the average peak sun hours for the five months that the system will be operating can be calculated as follows:

$$\frac{(6.5 + 6.9 + 7.5 + 7.3 + 6.3)}{5 \text{ months}} = 6.9 \text{ hours}$$

**Equation C12**

**Step 6. Design Flow Rate for the Pump**

The pump’s design flow rate is based on the operation’s estimated daily water needs (Step 1) divided by the number of peak sun hours per day (Step 5), calculated as shown below:

$$\frac{3,960 \text{ gallons}}{(6.9 \text{ peak sun hours} \times 60 \text{ minutes/hour})} = 9.6 \text{ gpm}$$

**Equation C13**

**Step 7. Total Dynamic Head (TDH) for the Pump**

To determine the pump’s TDH, use the following equation:

$$TDH = \text{Vertical Lift} + \text{Pressure Head.} + \text{Friction Losses}$$

**Equation C14**

**Vertical lift** is the vertical distance between the water surface at the intake point (the well’s water surface) and the water surface at the delivery point (the tank’s water surface). In this example:

$$\text{Vertical Lift} = 106 \text{ ft} + 9 \text{ ft} + 25 \text{ ft} + 13 \text{ ft}, 8 \text{ in} \approx 154 \text{ ft}$$

**Equation C15**

**Pressure head** is the pressure at the delivery point in the tank. For this example, there is no pressure at the delivery point (the tank’s water surface), so:

$$\text{Pressure Head} = 0 \text{ ft}$$

**Equation C16**

**Friction loss** is the loss of pressure due to the friction of the water as it flows through the pipe. Friction loss is determined by four factors: the pipe size (inside diameter), the flow rate, the length of the pipe, and the pipe’s roughness. Appendix G contains a list of calculated friction losses for different pipe sizes and flow rates for Schedule 40 PVC pipe.

For the given system layout, approximately 1,330 inches of 1½-inch diameter PVC pipe is needed to pipe water from the well to the storage tank. From Appendix G, the friction loss for 9.6 gpm flowing in a 1½-inch pipe is approximately 0.67 feet of head loss per 100 ft of pipe. Therefore, the total estimated friction loss for 1,330 ft of pipe is 8.9 ft (1,330 ft ÷ 100 ft of pipe x 0.67 ft/100 ft head loss = 8.9 ft). In addition, a head loss of 1.2 ft for the 181 ft of pipe in the well must be added, as well as 1.4 ft of minor losses, for a total friction loss of 11.5 ft (8.9 ft + 1.2 ft + 1.4 ft = 11.5 ft). (More details on hydraulic analysis are contained in the NRCS National Engineering Handbook, Part 634.) Therefore, the total dynamic head for the proposed pump can be calculated as follows:

$$\begin{aligned}
 TDH &= 154 \text{ ft} + 0 \text{ ft} + 11.5 \text{ ft} \\
 &= 166 \text{ ft} \rightarrow 170 \text{ ft}
 \end{aligned}$$

Equation C17

**Step 8. Pump Selection and Associated Power Requirement**

The pump can be selected by comparing the design flow rate and TDH calculated in Steps 6 and 7 with the manufacturer’s pump curves. The pump curves in Figure C6 (duplicated from Figure 11), below, are used for this scenario.

The first step for this example is to locate the flow rate of 9.6 gpm on the y-axis of the pump curve diagram. Draw a horizontal line across the chart through this point, as shown. Next, locate where this line intersects the curve representing a TDH of 170 ft. From this point of intersection, draw a vertical line to the bottom of the graph. The point where the vertical line crosses the x-axis shows the peak power requirement for the pump. As shown below, based on a calculated flow rate of 9.6 gpm and a TDH of 170 ft, a minimum input of 560 Watts of peak power is required. (The minimum operating voltage for the pump to run

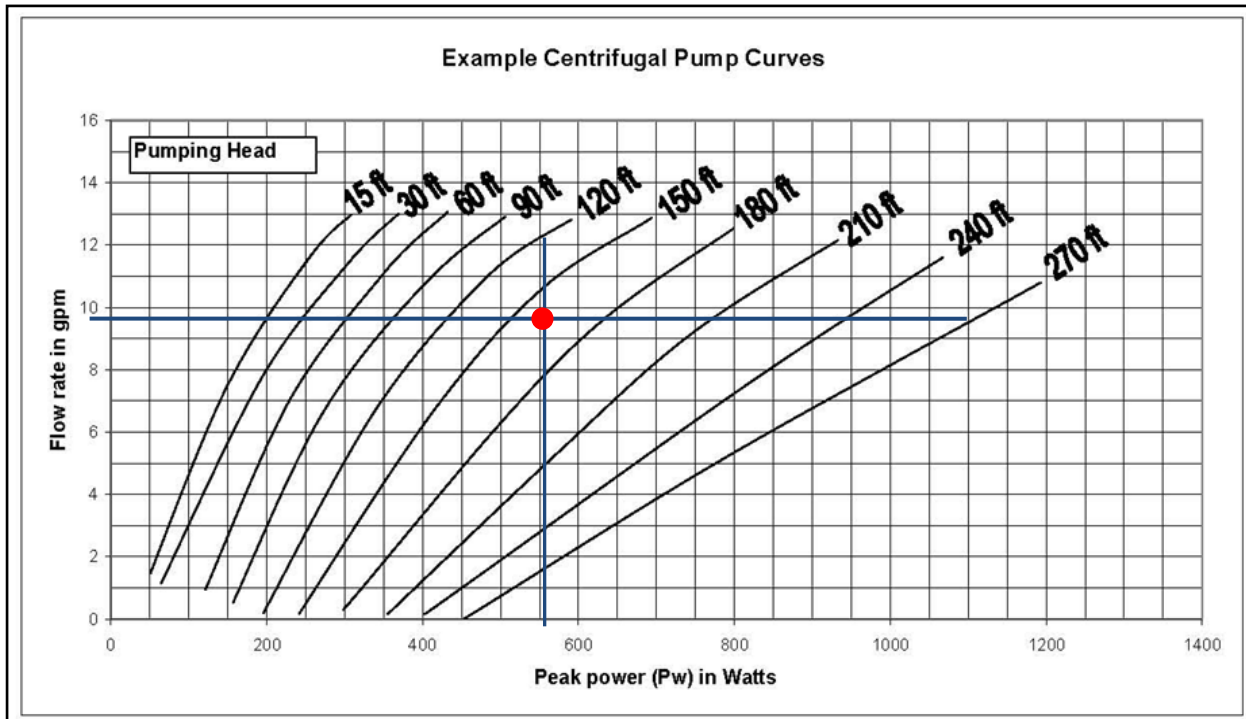

Figure C6 – Pump curves used for Design Example #2.



efficiently is specified as 100 volts by the manufacturer.)

**Step 9. PV Panel Selection and Array Layout**

The PV panels selected for this system must be able to provide the minimum energy requirement to run the pump. As determined in Step 8, the minimum power needed is 560 Watts. However, the panels must also have additional capacity to account for any potential reduction in power due high heat, dust, age, etc. Many PV panel manufacturers recommend increasing the minimum peak power value by 25% to account for these environmental factors. Therefore, the PV panels will be sized to provide a minimum output of 700 Watts (1.25 X 560 = 700 W).

A PV panel is selected that has the electrical characteristics shown in Table 3 (page 6): a peak power output of 117 W at 35.5 V and 3.3 A. Therefore, six panels are required to meet the pump’s power requirement. They will be wired in a combination of series and parallel (two groups of three panels wired in series with the groups wired in parallel) to provide the necessary voltage for the pump.

The total output voltage and current for six PV panels, as calculated below, proves they will be able to meet the pump’s needs. The output voltage for three panels wired in series is the sum of their individual voltages:

$$\begin{aligned} \text{Output voltage} &= 35.5 \text{ V} + 35.5 \text{ V} + 35.5 \text{ V} \\ &= 107.5 \text{ V} \end{aligned}$$

**Equation C18**

The output current for two groups of three panels wired in series is the sum of the current for each group:

$$\begin{aligned} \text{Output current} &= 3.3 \text{ A} + 3.3 \text{ A} \\ &= 6.6 \text{ A} \\ \\ \text{Total output power in Watts} &= \text{Volts} \times \text{Amps} \\ &= 107.5 \text{ V} \times 6.6 \text{ A} \\ &= 709.5 \text{ W} \end{aligned}$$

**Equation C19**

The array will therefore generate slightly more than the pump’s power requirement of 700 W.

**Step 10. PV Array Mounting and Foundation Requirements**

Since site conditions permit (i.e. the depth of embedment is not limited by shallow bedrock) and the site is located in an area where the recommended design wind speed tolerance is 85 mph or less, the standard details for mounting structure embedded posts listed in Appendix F may be used. (If the panels were going to be located in a high wind area, a more detailed analysis of the mounting structure would be needed.)

**Step 11. Water Flow Rates and Delivery Point Pressure**

The flow from the storage tank to the troughs is gravity fed. As noted in the given information for this example, a minimum of 2 psi (equal to 4.6 ft of head) is needed to activate the float valves in the water troughs. To ensure there is adequate pressure, determine the pressure head available at the water troughs for a modest flow rate of 4 gpm in the pipe, which would be sufficient to supply the daily water requirement for the troughs.

Water Trough #1

Water Trough #1 is at an elevation of 3,585 ft. It is 1,130 ft from the tank. Therefore:



$$\begin{aligned}
 & (Elev + Pressure Head)_{Tank} \\
 &= (Elev + Pressure Head)_{Trough} + Friction Loss \\
 & \\
 & (3,600 \text{ ft} + 0.5 \text{ ft})_{Tank} \\
 &= (3,585 \text{ ft} + Pressure Head)_{Trough} + Friction Loss \\
 & \\
 & \text{Tank Pressure Head} = 0.5 \text{ ft to conservatively} \\
 & \quad \text{assume the tank is near empty.} \\
 & \\
 & \text{Friction Loss (for } 1\frac{1}{2} \text{-inch pipe @ 4 gpm)} \\
 & \\
 &= \frac{0.13 \text{ ft}}{100 \text{ ft of pipe}} \times \text{length of } 1\frac{1}{2}\text{-inch pipe} \\
 & \\
 &= \frac{0.13 \text{ ft}}{100 \text{ ft of pipe}} \times \frac{1,130 \text{ ft}}{100 \text{ ft}} \\
 & \\
 &= 1.5 \text{ ft} \\
 & \\
 & \text{Pressure Head}_{Trough} \\
 &= 3,600 \text{ ft} + 0.5 \text{ ft} - 3,585 \text{ ft} - 1.5 \text{ ft} \\
 &= 14.0 \text{ ft} \\
 & \\
 & 14.0 \text{ ft is greater than the minimum} \\
 & \quad \text{requirement of 4.6 ft.}
 \end{aligned}$$

**Equation C20**

Since the pressure at the trough is greater than the required pressure needed to operate the float valve, the delivery system to this trough is acceptable. However, if additional pressure were needed, increasing the deliver pipe size would significantly reduce friction losses, thereby increasing the pressure available at the trough.

Water Trough #2

Water Trough #2 is at an elevation of 3,550 ft. It is 2,135 ft from the tank. Therefore, see Equation C21 (right).

$$\begin{aligned}
 & (Elev + Pressure Head)_{Tank} \\
 &= (Elev + Pressure Head)_{Trough} + Friction Loss \\
 & \\
 & (3,600 \text{ ft} + 0.5 \text{ ft})_{Tank} \\
 &= (3,550 \text{ ft} + Pressure Head)_{Trough} + Friction Loss \\
 & \\
 & \text{Tank Pressure Head} = 0.5 \text{ ft to conservatively} \\
 & \quad \text{assume the tank is near empty.} \\
 & \\
 & \text{Friction Loss (for } 1\frac{1}{2} \text{-inch pipe @ 4 gpm)} \\
 & \\
 &= \frac{0.13 \text{ ft}}{100 \text{ ft of pipe}} \times \text{length of } 1\frac{1}{2}\text{-inch pipe} \\
 & \\
 &= \frac{0.13 \text{ ft}}{100 \text{ ft of pipe}} \times \frac{2,135 \text{ ft}}{100 \text{ ft}} \\
 & \\
 &= 2.8 \text{ ft} \\
 & \\
 & \text{Pressure Head}_{Trough} \\
 &= 3,600 \text{ ft} + 0.5 \text{ ft} - 3,550 \text{ ft} - 2.8 \text{ ft} \\
 &= 47.7 \text{ ft} \\
 & \\
 & 47.7 \text{ ft is greater than the minimum} \\
 & \quad \text{requirement of 4.6 ft.}
 \end{aligned}$$

**Equation C21**

Since the pressure at this trough is greater than the required pressure needed to operate the float valve, the delivery system to this trough is also acceptable.

For additional information on flow rates and pipe sizing, see the Montana Stockwater Pipeline Manual.

**Step 12. Summary Description of the System**

The landowner must install a fence around the wellhead, the solar panel array, and the electronic controllers to provide protection against damage from the operation's livestock, as well as from the elk that are frequently

present. In addition, the PV array will be placed in a remote location away from roads and public lands. Therefore, damage from vandalism is not anticipated.

The system information can be recorded as follows:

Amps:	6.6 A
Volts:	106.5 V
Power Required (Performance Curve):	560 Watts
Solar Panel Rating:	234 Watts 107.5 Volts 6.6 Amps

The panel information for the system can be described as:

Number of Panels:	6
Panel Dimensions:	Length = 60 inches, Width = 26 inches
Recommended Safety Switches:	1. Run-dry switch so the pump does not run dry. 2. Tank float switch to stop the pump when the storage tank is full.

This information can be summarized on a copy of the drawings located in Appendix F, which can be provided as part of the design package.

# APPENDIX D: Solar Insolation Values for Oregon <sup>2</sup>

## Astoria, OR

WBAN NO. 94224

LATITUDE: 46.15° N  
 LONGITUDE: 123.88° W  
 ELEVATION: 7 meters  
 MEAN PRESSURE: 1017 millibars

STATION TYPE: Secondary

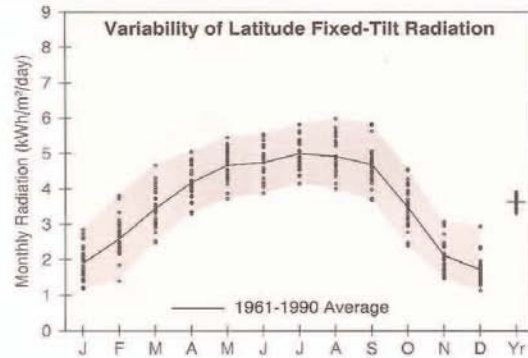

Solar Radiation for Flat-Plate Collectors Facing South at a Fixed Tilt (kWh/m<sup>2</sup>/day), Uncertainty ±9%

Tilt (°)		Jan	Feb	Mar	Apr	May	June	July	Aug	Sept	Oct	Nov	Dec	Year
0	Average	1.1	1.8	2.8	3.9	4.9	5.3	5.4	4.8	3.8	2.4	1.3	1.0	3.2
	Min/Max	0.9/1.4	1.3/2.3	2.3/3.4	3.3/4.5	4.0/5.6	4.4/6.1	4.6/6.2	4.0/5.6	3.3/4.5	1.9/2.9	1.1/1.6	0.9/1.3	3.0/3.4
Latitude -15	Average	1.7	2.4	3.4	4.3	5.0	5.2	5.4	5.1	4.7	3.3	2.0	1.5	3.7
	Min/Max	1.1/2.5	1.4/3.5	2.5/4.5	3.4/5.2	4.0/5.8	4.2/6.0	4.5/6.3	4.2/6.2	3.7/5.7	2.3/4.3	1.4/2.8	1.1/2.5	3.3/3.9
Latitude	Average	1.9	2.6	3.4	4.2	4.7	4.7	5.0	4.9	4.7	3.5	2.1	1.7	3.6
	Min/Max	1.2/2.8	1.4/3.8	2.5/4.7	3.3/5.0	3.7/5.4	3.9/5.5	4.1/5.8	4.0/6.0	3.7/5.8	2.4/4.6	1.5/3.1	1.1/2.9	3.3/3.9
Latitude +15	Average	2.0	2.6	3.3	3.8	4.1	4.1	4.4	4.4	4.5	3.5	2.2	1.8	3.4
	Min/Max	1.2/3.0	1.3/3.9	2.3/4.6	3.0/4.7	3.3/4.8	3.4/4.8	3.6/5.1	3.6/5.4	3.5/5.6	2.3/4.6	1.5/3.2	1.1/3.2	3.1/3.7
90	Average	1.8	2.2	2.6	2.7	2.7	2.5	2.7	3.0	3.4	2.9	1.9	1.6	2.5
	Min/Max	1.0/2.8	1.1/3.5	1.8/3.7	2.2/3.3	2.2/3.0	2.2/2.9	2.3/3.1	2.5/3.7	2.6/4.2	1.9/3.9	1.3/3.0	1.0/3.1	2.3/2.8

Solar Radiation for 1-Axis Tracking Flat-Plate Collectors with a North-South Axis (kWh/m<sup>2</sup>/day), Uncertainty ±9%

Axis Tilt (°)		Jan	Feb	Mar	Apr	May	June	July	Aug	Sept	Oct	Nov	Dec	Year
0	Average	1.5	2.3	3.5	4.9	6.1	6.4	6.7	6.1	5.2	3.3	1.7	1.3	4.1
	Min/Max	0.9/2.1	1.3/3.4	2.6/4.7	3.8/6.0	4.4/7.3	5.1/7.9	5.4/8.3	4.6/7.6	4.0/6.8	2.3/4.3	1.2/2.4	0.9/2.0	3.7/4.4
Latitude -15	Average	1.9	2.8	4.0	5.3	6.2	6.4	6.8	6.4	5.9	4.0	2.2	1.7	4.5
	Min/Max	1.2/3.0	1.4/4.3	2.8/5.5	3.9/6.6	4.5/7.6	5.1/8.0	5.4/8.4	4.8/8.1	4.4/7.8	2.6/5.3	1.5/3.2	1.1/3.0	4.0/4.9
Latitude	Average	2.1	2.9	4.1	5.2	6.0	6.1	6.6	6.3	5.9	4.1	2.3	1.8	4.5
	Min/Max	1.2/3.2	1.4/4.5	2.8/5.7	3.8/6.5	4.3/7.3	4.9/7.7	5.2/8.1	4.7/8.0	4.4/7.8	2.7/5.6	1.6/3.5	1.1/3.2	4.0/4.8
Latitude +15	Average	2.2	2.9	4.0	4.9	5.6	5.7	6.1	6.0	5.8	4.1	2.4	1.9	4.3
	Min/Max	1.2/3.4	1.4/4.6	2.7/5.6	3.6/6.2	4.0/6.9	4.5/7.2	4.8/7.6	4.4/7.6	4.2/7.7	2.6/5.6	1.6/3.6	1.2/3.5	3.9/4.7

Solar Radiation for 2-Axis Tracking Flat-Plate Collectors (kWh/m<sup>2</sup>/day), Uncertainty ±9%

Tracker		Jan	Feb	Mar	Apr	May	June	July	Aug	Sept	Oct	Nov	Dec	Year
2-Axis	Average	2.2	3.0	4.1	5.3	6.3	6.6	7.0	6.5	6.0	4.2	2.4	1.9	4.6
	Min/Max	1.2/3.4	1.4/4.6	2.8/5.7	4.0/6.6	4.5/7.7	5.3/8.2	5.6/8.6	4.9/8.2	4.4/7.9	2.7/5.6	1.6/3.6	1.2/3.6	4.2/5.0

Direct Beam Solar Radiation for Concentrating Collectors (kWh/m<sup>2</sup>/day), Uncertainty ±8%

Tracker		Jan	Feb	Mar	Apr	May	June	July	Aug	Sept	Oct	Nov	Dec	Year
1-Axis, E-W Horiz Axis	Average	1.1	1.4	1.7	2.1	2.5	2.7	3.1	2.9	2.9	2.1	1.2	1.0	2.1
	Min/Max	0.5/2.1	0.3/2.8	0.9/2.9	1.2/3.0	1.2/3.6	1.5/3.9	1.9/4.4	1.7/4.2	1.6/4.4	0.9/3.3	0.6/2.2	0.4/2.4	1.8/2.4
1-Axis, N-S Horiz Axis	Average	0.7	1.2	1.8	2.5	3.3	3.4	3.9	3.6	3.3	1.9	0.8	0.6	2.3
	Min/Max	0.3/1.4	0.3/2.3	0.9/2.9	1.5/3.7	1.5/4.7	2.0/5.0	2.5/5.7	2.0/5.3	1.8/5.2	0.8/3.0	0.4/1.5	0.2/1.4	1.9/2.6
1-Axis, N-S Tilt=Latitude	Average	1.2	1.7	2.3	2.8	3.3	3.3	3.8	3.8	3.9	2.6	1.3	1.1	2.6
	Min/Max	0.5/2.3	0.4/3.3	1.2/3.8	1.6/4.1	1.6/4.7	1.9/4.8	2.4/5.5	2.1/5.6	2.2/6.1	1.1/4.1	0.6/2.4	0.4/2.5	2.3/3.0
2-Axis	Average	1.3	1.7	2.3	2.8	3.5	3.6	4.1	4.0	3.9	2.7	1.4	1.1	2.7
	Min/Max	0.5/2.5	0.4/3.4	1.2/3.8	1.6/4.1	1.6/4.9	2.0/5.3	2.6/5.9	2.2/5.7	2.2/6.1	1.1/4.1	0.7/2.6	0.4/2.7	2.3/3.1

Average Climatic Conditions

Element	Jan	Feb	Mar	Apr	May	June	July	Aug	Sept	Oct	Nov	Dec	Year
Temperature (°C)	5.5	6.8	7.6	9.0	11.4	13.8	15.6	15.9	14.7	11.4	8.3	5.8	10.5
Daily Minimum Temp	2.2	2.9	3.4	4.6	7.1	9.7	11.3	11.4	9.4	6.7	4.6	2.6	6.3
Daily Maximum Temp	8.8	10.6	11.8	13.3	15.6	17.8	19.7	20.4	19.9	16.2	11.9	9.0	14.6
Record Minimum Temp	-11.7	-12.8	-5.6	-1.7	-1.1	2.8	3.9	3.9	0.6	-3.3	-9.4	-14.4	-14.4
Record Maximum Temp	19.4	22.2	22.8	28.3	30.6	33.9	37.8	35.6	35.0	29.4	21.7	17.8	37.8
HDD, Base 18.3°C	398	323	332	280	216	135	87	78	112	213	302	389	2866
CDD, Base 18.3°C	0	0	0	0	0	0	0	4	0	0	0	0	4
Relative Humidity (%)	83	82	81	79	79	80	80	82	81	83	83	84	81
Wind Speed (m/s)	4.3	4.2	4.1	4.1	3.9	4.1	4.0	3.8	3.5	3.5	4.1	4.1	4.0

<sup>2</sup> Source: <http://redc.nrel.gov/solar/pubs/redbook/PDFs/OR.PDF> (September, 2010)



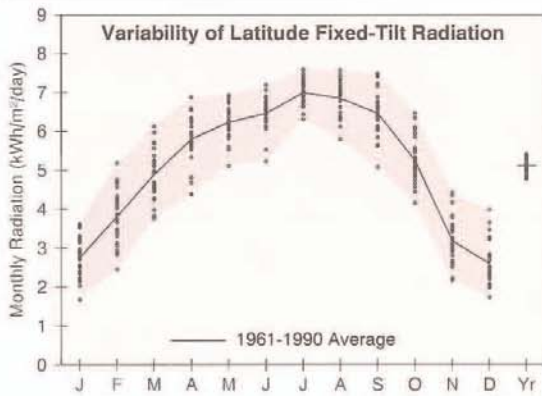

**Boise, ID**  
**WBAN NO. 24131**

LATITUDE: 43.57° N  
 LONGITUDE: 116.22° W  
 ELEVATION: 874 meters  
 MEAN PRESSURE: 916 millibars  
 STATION TYPE: Primary

Solar Radiation for Flat-Plate Collectors Facing South at a Fixed Tilt (kWh/m<sup>2</sup>/day), Uncertainty ±9%

Tilt (°)		Jan	Feb	Mar	Apr	May	June	July	Aug	Sept	Oct	Nov	Dec	Year
0	Average	1.6	2.5	3.8	5.3	6.5	7.2	7.6	6.6	5.1	3.4	1.9	1.4	4.4
	Min/Max	1.3/2.0	1.9/3.0	3.1/4.4	4.2/6.1	5.5/7.2	5.9/8.0	6.9/8.3	5.6/7.2	4.3/5.8	2.9/3.9	1.4/2.3	1.2/1.8	4.2/4.6
Latitude -15	Average	2.5	3.5	4.7	5.9	6.7	7.1	7.6	7.1	6.3	4.9	2.9	2.3	5.1
	Min/Max	1.6/3.2	2.3/4.7	3.7/5.8	4.5/7.0	5.5/7.4	5.7/7.9	6.8/8.2	6.0/7.9	5.0/7.3	3.9/5.9	2.0/3.9	1.6/3.4	4.8/5.4
Latitude	Average	2.8	3.8	4.9	5.8	6.2	6.5	7.0	6.8	6.5	5.2	3.2	2.6	5.1
	Min/Max	1.7/3.6	2.5/5.2	3.8/6.1	4.4/6.9	5.1/6.9	5.2/7.2	6.3/7.6	5.8/7.6	5.1/7.5	4.2/6.5	2.2/4.4	1.7/4.0	4.8/5.4
Latitude +15	Average	2.9	3.9	4.8	5.4	5.5	5.5	6.0	6.2	6.2	5.3	3.3	2.8	4.8
	Min/Max	1.7/3.9	2.5/5.4	3.6/6.1	4.0/6.4	4.5/6.1	4.5/6.2	5.5/6.5	5.3/6.8	4.8/7.2	4.2/6.6	2.2/4.7	1.8/4.3	4.5/5.1
90	Average	2.7	3.4	3.7	3.6	3.2	3.0	3.3	3.8	4.6	4.5	3.0	2.6	3.5
	Min/Max	1.5/3.8	2.1/4.9	2.8/4.8	2.8/4.3	2.7/3.5	2.6/3.2	3.0/3.5	3.3/4.2	3.5/5.3	3.5/5.6	1.9/4.3	1.7/4.2	3.2/3.8

Solar Radiation for 1-Axis Tracking Flat-Plate Collectors with a North-South Axis (kWh/m<sup>2</sup>/day), Uncertainty ±9%

Axis Tilt (°)		Jan	Feb	Mar	Apr	May	June	July	Aug	Sept	Oct	Nov	Dec	Year
0	Average	2.2	3.5	5.4	7.4	9.0	10.0	10.9	9.5	7.8	5.2	2.7	2.0	6.3
	Min/Max	1.5/2.9	2.3/4.8	3.9/6.7	5.3/8.8	7.1/10.3	7.6/11.4	9.5/12.2	7.6/10.9	6.0/9.3	4.1/6.3	1.8/3.6	1.4/2.9	5.8/6.7
Latitude -15	Average	2.9	4.3	6.1	7.9	9.2	10.0	11.0	10.1	8.7	6.3	3.4	2.7	6.9
	Min/Max	1.7/3.8	2.7/6.0	4.4/7.7	5.5/9.6	7.3/10.6	7.6/11.4	9.6/12.4	8.0/11.6	6.6/10.5	4.8/7.8	2.3/4.8	1.7/4.1	6.3/7.3
Latitude	Average	3.1	4.5	6.2	7.8	9.0	9.6	10.7	9.9	8.8	6.6	3.7	2.9	6.9
	Min/Max	1.8/4.2	2.8/6.4	4.4/8.0	5.4/9.5	7.0/10.3	7.3/11.0	9.3/12.0	7.9/11.4	6.7/10.6	5.0/8.3	2.4/5.2	1.8/4.6	6.3/7.4
Latitude +15	Average	3.2	4.6	6.1	7.5	8.5	9.0	10.0	9.5	8.6	6.7	3.8	3.1	6.7
	Min/Max	1.8/4.4	2.8/6.6	4.3/7.9	5.2/9.2	6.6/9.8	6.8/10.3	8.7/11.3	7.5/10.9	6.5/10.4	5.0/8.4	2.4/5.5	1.9/4.9	6.1/7.2

Solar Radiation for 2-Axis Tracking Flat-Plate Collectors (kWh/m<sup>2</sup>/day), Uncertainty ±9%

Tracker		Jan	Feb	Mar	Apr	May	June	July	Aug	Sept	Oct	Nov	Dec	Year
2-Axis	Average	3.3	4.6	6.2	7.9	9.4	10.3	11.3	10.1	8.8	6.7	3.8	3.1	7.1
	Min/Max	1.8/4.4	2.8/6.6	4.4/8.0	5.6/9.6	7.4/10.8	7.8/11.8	9.8/12.7	8.1/11.6	6.7/10.6	5.1/8.4	2.4/5.5	1.9/5.0	6.5/7.6

Direct Beam Solar Radiation for Concentrating Collectors (kWh/m<sup>2</sup>/day), Uncertainty ±8%

Tracker		Jan	Feb	Mar	Apr	May	June	July	Aug	Sept	Oct	Nov	Dec	Year
1-Axis, E-W Horiz Axis	Average	1.7	2.4	3.0	3.8	4.7	5.5	6.4	5.6	5.0	4.0	2.2	1.7	3.8
	Min/Max	0.4/2.8	1.0/3.9	1.8/4.5	1.8/5.2	3.1/5.9	3.4/6.9	5.1/7.6	3.9/7.0	3.3/6.4	2.6/5.7	0.9/3.6	0.6/3.4	3.3/4.3
1-Axis, N-S Horiz Axis	Average	1.1	2.1	3.4	4.9	6.3	7.3	8.7	7.5	6.1	3.9	1.6	1.1	4.5
	Min/Max	0.3/1.9	0.9/3.4	1.9/5.1	2.4/6.7	4.2/8.0	4.5/9.2	6.8/10.4	5.1/9.4	4.0/7.9	2.5/5.4	0.7/2.6	0.4/2.1	3.8/5.0
1-Axis, N-S Tilt=Latitude	Average	1.8	2.9	4.1	5.3	6.3	7.0	8.4	7.7	6.9	5.0	2.5	1.8	5.0
	Min/Max	0.5/3.0	1.2/4.7	2.4/6.1	2.6/7.2	4.1/7.9	4.3/8.8	6.6/10.0	5.3/9.7	4.6/9.1	3.3/7.2	1.1/4.0	0.6/3.6	4.2/5.6
2-Axis	Average	1.9	3.0	4.1	5.4	6.6	7.6	9.0	8.0	7.0	5.1	2.6	2.0	5.2
	Min/Max	0.5/3.2	1.3/4.8	2.4/6.1	2.6/7.3	4.4/8.3	4.7/9.5	7.1/10.7	5.5/10.0	4.6/9.1	3.3/7.3	1.1/4.3	0.7/3.9	4.4/5.8

Average Climatic Conditions

Element	Jan	Feb	Mar	Apr	May	June	July	Aug	Sept	Oct	Nov	Dec	Year
Temperature (°C)	-1.7	2.2	5.8	9.5	14.2	19.2	23.3	22.5	17.0	11.0	4.4	-1.1	10.5
Daily Minimum Temp	-5.8	-2.5	-0.1	2.6	6.6	11.2	14.3	13.8	9.0	3.9	-0.5	-5.3	3.9
Daily Maximum Temp	2.4	6.8	11.6	16.3	21.7	27.2	32.3	31.2	25.0	18.1	9.3	3.2	17.1
Record Minimum Temp	-27.2	-26.1	-14.4	-7.2	-5.6	-0.6	1.7	2.8	-5.0	-11.7	-19.4	-31.7	-31.7
Record Maximum Temp	17.2	21.1	27.2	33.3	36.7	42.8	43.9	43.3	38.9	32.8	23.3	18.3	43.9
HDD, Base 18.3°C	620	453	389	265	134	42	3	11	89	230	418	601	3256
CDD, Base 18.3°C	0	0	0	0	5	67	158	140	49	0	0	0	419
Relative Humidity (%)	75	70	59	52	49	45	36	37	45	54	69	75	55
Wind Speed (m/s)	3.2	3.8	4.2	4.3	4.2	3.9	3.6	3.5	3.5	3.4	3.6	3.3	3.7

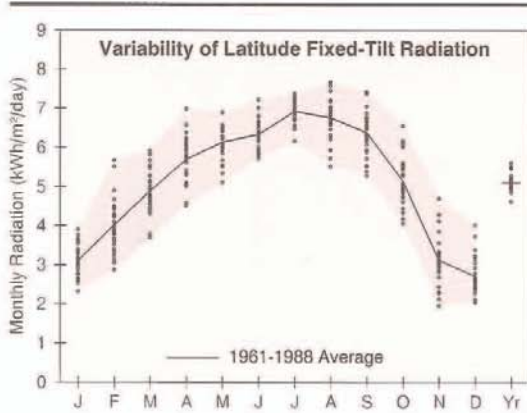

**Burns, OR**  
**WBAN NO. 94185**

LATITUDE: 43.58° N  
 LONGITUDE: 119.05° W  
 ELEVATION: 1271 meters  
 MEAN PRESSURE: 874 millibars  
 STATION TYPE: Primary

Solar Radiation for Flat-Plate Collectors Facing South at a Fixed Tilt (kWh/m<sup>2</sup>/day). Uncertainty ±9%

Tilt (°)		Jan	Feb	Mar	Apr	May	June	July	Aug	Sept	Oct	Nov	Dec	Year
0	Average	1.8	2.6	3.8	5.2	6.4	7.1	7.5	6.5	5.1	3.4	1.9	1.5	4.4
	Min/Max	1.5/2.0	2.2/3.3	3.1/4.5	4.4/6.2	5.5/7.2	6.4/8.1	6.8/8.1	5.4/7.3	4.3/5.7	2.8/4.0	1.4/2.4	1.1/1.8	4.1/4.7
Latitude -15	Average	2.8	3.7	4.7	5.8	6.5	6.9	7.5	7.0	6.3	4.8	2.8	2.4	5.1
	Min/Max	2.1/3.4	2.7/5.1	3.7/5.7	4.7/7.1	5.5/7.3	6.2/7.9	6.7/8.0	5.8/8.0	5.3/7.2	3.8/6.0	1.9/4.1	1.9/3.4	4.7/5.6
Latitude	Average	3.1	4.0	4.9	5.7	6.1	6.3	6.9	6.8	6.4	5.2	3.1	2.7	5.1
	Min/Max	2.3/3.9	2.9/5.7	3.7/5.9	4.5/7.0	5.1/6.9	5.7/7.2	6.2/7.4	5.5/7.7	5.3/7.4	4.1/6.6	2.0/4.7	2.0/4.0	4.6/5.6
Latitude +15	Average	3.3	4.1	4.8	5.3	5.4	5.4	6.0	6.1	6.1	5.2	3.3	2.9	4.8
	Min/Max	2.4/4.2	2.8/5.9	3.5/5.8	4.2/6.5	4.5/6.1	4.9/6.2	5.3/6.3	5.0/6.9	5.0/7.2	4.1/6.7	2.0/5.0	2.1/4.3	4.3/5.3
90	Average	3.2	3.7	3.8	3.6	3.2	3.0	3.3	3.8	4.5	4.4	2.9	2.8	3.5
	Min/Max	2.3/3.9	2.4/5.4	2.8/4.6	2.9/4.4	2.7/3.5	2.8/3.3	2.9/3.4	3.2/4.3	3.6/5.3	3.3/5.7	1.7/4.6	2.0/4.2	3.1/3.9

Solar Radiation for 1-Axis Tracking Flat-Plate Collectors with a North-South Axis (kWh/m<sup>2</sup>/day). Uncertainty ±9%

Axis Tilt (°)		Jan	Feb	Mar	Apr	May	June	July	Aug	Sept	Oct	Nov	Dec	Year
0	Average	2.5	3.7	5.3	7.2	8.8	9.7	10.7	9.4	7.6	5.1	2.6	2.1	6.3
	Min/Max	2.0/3.1	2.7/5.2	3.8/6.4	5.6/8.9	7.0/10.1	8.4/11.4	9.6/11.8	7.2/11.1	6.3/9.1	4.0/6.6	1.8/3.9	1.6/3.0	5.6/6.8
Latitude -15	Average	3.3	4.5	6.0	7.7	9.0	9.8	10.9	10.0	8.6	6.2	3.4	2.8	6.8
	Min/Max	2.4/4.2	3.1/6.6	4.3/7.4	5.8/9.7	7.1/10.4	8.4/11.5	9.8/12.0	7.6/11.8	7.0/10.2	4.7/8.0	2.0/5.1	2.0/4.2	6.1/7.5
Latitude	Average	3.5	4.8	6.1	7.6	8.7	9.4	10.5	9.8	8.7	6.5	3.6	3.1	6.9
	Min/Max	2.6/4.6	3.2/7.0	4.3/7.6	5.8/9.6	6.9/10.1	8.0/11.1	9.4/11.6	7.4/11.6	7.0/10.4	4.9/8.4	2.1/5.6	2.2/4.7	6.1/7.6
Latitude +15	Average	3.7	4.8	6.1	7.3	8.2	8.8	9.9	9.3	8.5	6.5	3.7	3.2	6.7
	Min/Max	2.7/4.8	3.2/7.2	4.2/7.5	5.5/9.3	6.5/9.6	7.5/10.4	8.9/10.9	7.0/11.1	6.8/10.2	4.9/8.5	2.1/5.8	2.3/4.9	5.9/7.4

Solar Radiation for 2-Axis Tracking Flat-Plate Collectors (kWh/m<sup>2</sup>/day). Uncertainty ±9%

Tracker		Jan	Feb	Mar	Apr	May	June	July	Aug	Sept	Oct	Nov	Dec	Year
2-Axis	Average	3.7	4.9	6.2	7.7	9.1	10.0	11.1	10.0	8.7	6.5	3.7	3.3	7.1
	Min/Max	2.7/4.8	3.3/7.2	4.3/7.6	5.9/9.7	7.2/10.6	8.6/11.8	10.0/12.2	7.6/11.8	7.0/10.4	4.9/8.5	2.2/5.9	2.3/5.0	6.3/7.8

Direct Beam Solar Radiation for Concentrating Collectors (kWh/m<sup>2</sup>/day). Uncertainty ±8%

Tracker		Jan	Feb	Mar	Apr	May	June	July	Aug	Sept	Oct	Nov	Dec	Year
1-Axis, E-W Horiz Axis	Average	1.9	2.4	2.9	3.5	4.4	5.1	6.2	5.5	4.8	3.8	2.0	1.8	3.7
	Min/Max	0.9/3.1	0.8/4.4	1.6/4.0	1.9/5.2	2.7/5.5	3.8/6.6	5.3/7.1	3.3/6.9	3.5/6.1	2.3/5.5	0.6/3.9	0.9/3.4	3.2/4.3
1-Axis, N-S Horiz Axis	Average	1.3	2.1	3.2	4.6	5.9	6.9	8.3	7.3	5.9	3.7	1.5	1.1	4.3
	Min/Max	0.6/2.1	0.6/3.8	1.7/4.4	2.6/6.6	3.7/7.4	5.1/8.9	7.2/9.6	4.4/9.4	4.3/7.6	2.3/5.3	0.5/2.9	0.5/2.2	3.7/5.0
1-Axis, N-S Tilt=Latitude	Average	2.1	2.9	3.9	4.9	5.8	6.5	8.1	7.5	6.7	4.9	2.3	1.9	4.8
	Min/Max	1.0/3.4	0.9/5.3	2.1/5.4	2.8/7.2	3.6/7.3	4.8/8.4	7.0/9.3	4.6/9.7	4.9/8.7	2.9/7.0	0.7/4.4	0.9/3.6	4.0/5.6
2-Axis	Average	2.2	3.0	3.9	5.0	6.1	7.1	8.7	7.8	6.8	4.9	2.4	2.0	5.0
	Min/Max	1.0/3.7	0.9/5.5	2.1/5.4	2.8/7.3	3.8/7.7	5.2/9.2	7.5/10.0	4.7/10.0	4.9/8.7	3.0/7.1	0.7/4.6	1.0/3.9	4.2/5.8

Average Climatic Conditions

Element	Jan	Feb	Mar	Apr	May	June	July	Aug	Sept	Oct	Nov	Dec	Year
Temperature (°C)	-4.8	-1.4	2.4	6.0	10.4	14.4	19.0	17.9	12.8	7.2	0.9	-3.8	6.7
Daily Minimum Temp	-10.6	-7.1	-3.9	-1.7	2.2	5.3	8.4	7.2	2.4	-2.2	-5.6	-9.4	-1.2
Daily Maximum Temp	0.9	4.2	8.7	13.6	18.7	23.6	29.5	28.5	23.1	16.6	7.3	1.8	14.7
Record Minimum Temp	-32.8	-33.3	-15.6	-8.9	-5.6	-5.0	-3.9	-2.2	-8.3	-19.4	-25.0	-28.9	-33.3
Record Maximum Temp	12.8	17.2	23.3	28.9	33.9	35.0	37.2	38.3	36.1	30.0	22.0	14.4	38.3
HDD, Base 18.3°C	718	554	494	370	244	124	32	57	175	344	523	687	4325
CDD, Base 18.3°C	0	0	0	0	0	8	53	43	8	0	0	0	112
Relative Humidity (%)	78	75	65	55	51	49	38	40	46	57	74	79	59
Wind Speed (m/s)	2.1	2.2	3.0	3.5	3.4	3.0	3.0	2.3	2.5	2.3	2.2	2.4	2.7



**Eugene, OR**  
**WBAN NO. 24221**

LATITUDE: 44.12° N  
 LONGITUDE: 123.22° W  
 ELEVATION: 109 meters  
 MEAN PRESSURE: 1004 millibars  
 STATION TYPE: Primary

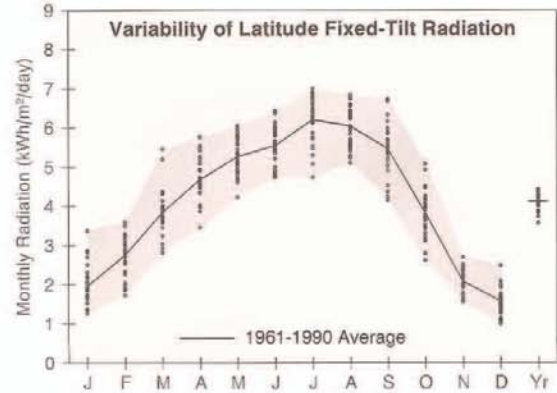

**Solar Radiation for Flat-Plate Collectors Facing South at a Fixed Tilt (kWh/m<sup>2</sup>/day), Uncertainty ±9%**

Tilt (°)		Jan	Feb	Mar	Apr	May	June	July	Aug	Sept	Oct	Nov	Dec	Year
0	Average	1.3	2.0	3.1	4.4	5.5	6.2	6.7	5.8	4.4	2.7	1.4	1.0	3.7
	Min/Max	0.9/1.7	1.4/2.4	2.5/4.0	3.5/5.2	4.6/6.3	5.3/7.2	5.2/7.6	5.0/6.5	3.5/5.2	2.1/3.3	1.1/1.7	0.7/1.3	3.3/4.0
Latitude -15	Average	1.8	2.6	3.8	4.8	5.6	6.0	6.7	6.3	5.4	3.6	1.9	1.4	4.2
	Min/Max	1.2/3.0	1.7/3.3	2.8/5.2	3.6/5.9	4.5/6.4	5.2/7.0	5.1/7.6	5.3/7.1	4.1/6.6	2.6/4.7	1.5/2.5	0.9/2.2	3.7/4.5
Latitude	Average	2.0	2.7	3.8	4.7	5.3	5.5	6.2	6.0	5.5	3.8	2.1	1.6	4.1
	Min/Max	1.3/3.4	1.7/3.6	2.8/5.4	3.5/5.8	4.2/6.1	4.7/6.4	4.7/7.0	5.1/6.8	4.2/6.7	2.6/5.1	1.5/2.7	1.0/2.5	3.6/4.4
Latitude +15	Average	2.0	2.8	3.7	4.3	4.6	4.8	5.4	5.5	5.2	3.8	2.1	1.6	3.8
	Min/Max	1.3/3.6	1.7/3.7	2.7/5.4	3.2/5.3	3.8/5.3	4.1/5.5	4.1/6.1	4.6/6.2	4.0/6.5	2.5/5.1	1.5/2.8	1.0/2.7	3.3/4.1
90	Average	1.8	2.3	2.9	3.0	2.8	2.7	3.1	3.5	3.9	3.2	1.8	1.5	2.7
	Min/Max	1.1/3.3	1.4/3.2	2.0/4.3	2.2/3.7	2.4/3.2	2.4/3.0	2.5/3.3	3.0/3.9	2.9/4.8	2.0/4.3	1.3/2.5	0.9/2.5	2.3/2.9

**Solar Radiation for 1-Axis Tracking Flat-Plate Collectors with a North-South Axis (kWh/m<sup>2</sup>/day), Uncertainty ±9%**

Axis Tilt (°)		Jan	Feb	Mar	Apr	May	June	July	Aug	Sept	Oct	Nov	Dec	Year
0	Average	1.6	2.5	4.0	5.6	7.2	8.1	9.2	8.1	6.3	3.7	1.8	1.2	5.0
	Min/Max	1.0/2.6	1.6/3.4	2.9/5.7	3.9/7.1	5.4/8.6	6.4/9.9	6.4/10.8	6.4/9.4	4.5/7.9	2.6/4.9	1.3/2.3	0.8/1.8	4.2/5.4
Latitude -15	Average	2.0	3.0	4.5	6.0	7.3	8.1	9.4	8.5	7.1	4.4	2.2	1.6	5.3
	Min/Max	1.3/3.5	1.8/4.1	3.1/6.6	4.1/7.6	5.5/8.9	6.4/9.9	6.4/11.0	6.7/10.0	5.0/8.9	2.8/6.0	1.6/2.9	1.0/2.5	4.5/5.8
Latitude	Average	2.1	3.1	4.6	5.9	7.1	7.8	9.1	8.4	7.1	4.6	2.3	1.7	5.3
	Min/Max	1.3/3.9	1.9/4.3	3.1/6.8	4.0/7.6	5.3/8.6	6.1/9.6	6.2/10.7	6.5/9.8	5.0/9.1	2.9/6.3	1.6/3.0	1.0/2.8	4.5/5.8
Latitude +15	Average	2.2	3.1	4.5	5.6	6.7	7.3	8.5	8.0	6.9	4.6	2.3	1.7	5.1
	Min/Max	1.3/4.0	1.8/4.3	3.0/6.7	3.8/7.3	4.9/8.1	5.7/8.9	5.8/10.0	6.2/9.4	4.9/8.9	2.8/6.3	1.6/3.1	1.0/2.9	4.3/5.6

**Solar Radiation for 2-Axis Tracking Flat-Plate Collectors (kWh/m<sup>2</sup>/day), Uncertainty ±9%**

Tracker		Jan	Feb	Mar	Apr	May	June	July	Aug	Sept	Oct	Nov	Dec	Year
2-Axis	Average	2.2	3.2	4.6	6.0	7.4	8.3	9.6	8.6	7.1	4.6	2.3	1.7	5.5
	Min/Max	1.4/4.1	1.9/4.4	3.2/6.8	4.1/7.7	5.5/9.0	6.6/10.2	6.6/11.3	6.7/10.0	5.1/9.1	2.9/6.3	1.7/3.1	1.0/3.0	4.6/6.0

**Direct Beam Solar Radiation for Concentrating Collectors (kWh/m<sup>2</sup>/day), Uncertainty ±8%**

Tracker		Jan	Feb	Mar	Apr	May	June	July	Aug	Sept	Oct	Nov	Dec	Year
1-Axis, E-W Horiz Axis	Average	1.1	1.4	2.0	2.5	3.2	3.9	5.0	4.4	3.8	2.4	1.1	0.8	2.6
	Min/Max	0.4/2.5	0.5/2.3	1.0/3.6	1.2/3.6	1.9/4.4	2.5/5.8	2.7/6.7	2.9/5.7	2.2/5.2	0.8/3.8	0.4/1.8	0.2/2.0	2.0/3.1
1-Axis, N-S Horiz Axis	Average	0.7	1.2	2.1	3.1	4.3	5.2	6.7	5.8	4.4	2.3	0.8	0.5	3.1
	Min/Max	0.3/1.7	0.4/2.0	1.0/3.8	1.5/4.6	2.4/5.8	3.3/7.6	3.5/8.8	3.7/7.6	2.6/6.2	0.8/3.5	0.3/1.3	0.1/1.2	2.3/3.6
1-Axis, N-S Tilt=Latitude	Average	1.1	1.7	2.6	3.4	4.2	4.9	6.5	6.0	5.1	3.0	1.2	0.8	3.4
	Min/Max	0.4/2.7	0.6/2.8	1.3/4.7	1.6/4.9	2.4/5.8	3.1/7.2	3.4/8.5	3.8/7.8	3.0/7.2	1.0/4.7	0.5/2.0	0.2/2.0	2.6/4.0
2-Axis	Average	1.2	1.7	2.6	3.4	4.5	5.4	7.0	6.2	5.1	3.0	1.2	0.9	3.5
	Min/Max	0.5/2.9	0.6/2.8	1.3/4.7	1.6/5.0	2.5/6.1	3.4/7.8	3.7/9.2	4.0/8.1	3.0/7.2	1.1/4.8	0.5/2.1	0.2/2.2	2.7/4.1

**Average Climatic Conditions**

Element	Jan	Feb	Mar	Apr	May	June	July	Aug	Sept	Oct	Nov	Dec	Year
Temperature (°C)	4.9	6.8	8.6	10.3	13.2	16.7	19.6	19.8	17.1	12.3	7.8	5.1	11.8
Daily Minimum Temp	1.8	2.8	3.8	4.8	6.9	9.8	11.6	11.8	9.6	6.4	4.3	2.2	6.3
Daily Maximum Temp	8.0	10.8	13.3	15.8	19.5	23.4	27.6	27.7	24.6	18.1	11.3	7.9	17.3
Record Minimum Temp	-20.0	-19.4	-6.7	-2.8	-2.2	0.0	3.9	3.3	0.0	-7.2	-11.1	-24.4	-24.4
Record Maximum Temp	19.4	21.7	25.0	30.0	33.9	37.8	40.6	42.2	39.4	34.4	24.4	20.0	42.2
HDD, Base 18.3°C	417	323	303	240	158	67	21	17	64	188	315	412	2526
CDD, Base 18.3°C	0	0	0	0	0	17	61	61	28	0	0	0	167
Relative Humidity (%)	87	85	80	76	74	70	64	65	70	81	88	89	77
Wind Speed (m/s)	3.4	3.5	3.7	3.5	3.3	3.4	3.5	3.3	3.3	2.9	3.5	3.4	3.4

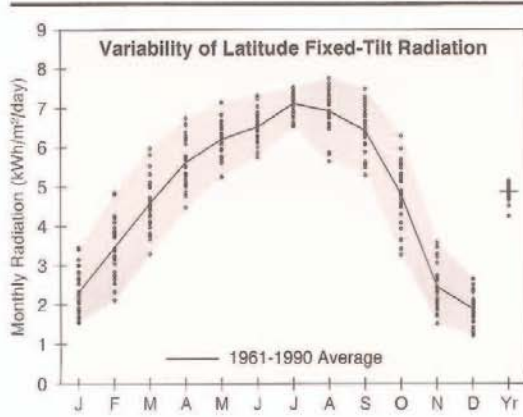

**Medford, OR**

**WBAN NO. 24225**

LATITUDE: 42.37° N  
 LONGITUDE: 122.87° W  
 ELEVATION: 396 meters  
 MEAN PRESSURE: 970 millibars

STATION TYPE: Primary

**Solar Radiation for Flat-Plate Collectors Facing South at a Fixed Tilt (kWh/m²/day), Uncertainty ±9%**

Tilt (°)		Jan	Feb	Mar	Apr	May	June	July	Aug	Sept	Oct	Nov	Dec	Year
0	Average	1.5	2.4	3.7	5.2	6.5	7.3	7.7	6.7	5.2	3.3	1.7	1.2	4.4
	Min/Max	1.1/1.9	1.8/3.0	2.9/4.4	4.3/6.1	5.5/7.4	6.4/8.2	7.1/8.2	5.4/7.4	4.5/5.9	2.6/4.0	1.2/2.1	0.9/1.5	4.0/4.5
Latitude -15	Average	2.1	3.2	4.5	5.7	6.6	7.1	7.7	7.2	6.3	4.5	2.3	1.7	4.9
	Min/Max	1.5/3.0	2.1/4.4	3.3/5.7	4.6/6.8	5.6/7.6	6.3/8.0	7.1/8.2	5.8/8.1	5.3/7.3	3.2/5.8	1.5/3.2	1.1/2.3	4.3/5.1
Latitude	Average	2.3	3.5	4.6	5.6	6.2	6.5	7.1	6.9	6.4	4.8	2.4	1.9	4.9
	Min/Max	1.5/3.5	2.1/4.8	3.3/6.0	4.5/6.7	5.2/7.1	5.8/7.3	6.5/7.5	5.6/7.8	5.3/7.5	3.3/6.3	1.5/3.6	1.2/2.6	4.3/5.1
Latitude +15	Average	2.4	3.5	4.5	5.2	5.5	5.6	6.2	6.3	6.2	4.8	2.5	2.0	4.5
	Min/Max	1.5/3.7	2.1/5.0	3.2/5.9	4.1/6.3	4.6/6.3	5.0/6.3	5.7/6.5	5.1/7.0	5.0/7.2	3.2/6.4	1.5/3.7	1.2/2.8	3.9/4.8
90	Average	2.2	3.0	3.4	3.5	3.1	2.9	3.2	3.8	4.4	4.0	2.2	1.8	3.1
	Min/Max	1.3/3.4	1.7/4.3	2.4/4.6	2.7/4.1	2.7/3.5	2.7/3.2	3.0/3.3	3.2/4.2	3.6/5.2	2.6/5.4	1.3/3.3	1.1/2.6	2.7/3.4

**Solar Radiation for 1-Axis Tracking Flat-Plate Collectors with a North-South Axis (kWh/m²/day), Uncertainty ±9%**

Axis Tilt (°)		Jan	Feb	Mar	Apr	May	June	July	Aug	Sept	Oct	Nov	Dec	Year
0	Average	1.9	3.1	4.9	6.9	8.7	9.8	11.0	9.5	7.6	4.7	2.1	1.5	6.0
	Min/Max	1.3/2.8	2.0/4.5	3.2/6.4	5.2/8.6	6.9/10.4	8.3/11.6	9.4/11.9	7.2/11.3	6.2/9.2	3.2/6.2	1.3/3.0	1.0/2.0	5.1/6.3
Latitude -15	Average	2.4	3.8	5.5	7.4	8.9	9.9	11.1	10.0	8.5	5.6	2.5	1.9	6.5
	Min/Max	1.5/3.7	2.2/5.5	3.6/7.4	5.5/9.3	7.1/10.7	8.3/11.6	9.5/12.1	7.6/11.9	6.8/10.3	3.7/7.5	1.5/3.8	1.2/2.7	5.5/6.8
Latitude	Average	2.6	4.0	5.6	7.3	8.7	9.5	10.7	9.9	8.6	5.9	2.7	2.0	6.5
	Min/Max	1.6/4.0	2.3/5.9	3.6/7.6	5.4/9.2	6.8/10.4	8.0/11.2	9.2/11.7	7.4/11.7	6.9/10.4	3.8/7.9	1.6/4.1	1.3/3.0	5.4/6.9
Latitude +15	Average	2.6	4.0	5.5	7.0	8.1	8.9	10.1	9.4	8.4	5.9	2.8	2.1	6.2
	Min/Max	1.6/4.2	2.2/6.0	3.5/7.5	5.1/8.9	6.4/9.8	7.4/10.5	8.6/11.0	7.1/11.1	6.7/10.2	3.8/8.0	1.6/4.2	1.3/3.1	5.2/6.7

**Solar Radiation for 2-Axis Tracking Flat-Plate Collectors (kWh/m²/day), Uncertainty ±9%**

Tracker		Jan	Feb	Mar	Apr	May	June	July	Aug	Sept	Oct	Nov	Dec	Year
2-Axis	Average	2.7	4.0	5.6	7.4	9.0	10.1	11.3	10.1	8.6	5.9	2.8	2.1	6.7
	Min/Max	1.6/4.2	2.3/6.0	3.6/7.6	5.5/9.3	7.2/10.8	8.5/11.9	9.7/12.4	7.6/11.9	6.9/10.4	3.8/8.0	1.6/4.2	1.3/3.2	5.6/7.1

**Direct Beam Solar Radiation for Concentrating Collectors (kWh/m²/day), Uncertainty ±8%**

Tracker		Jan	Feb	Mar	Apr	May	June	July	Aug	Sept	Oct	Nov	Dec	Year
1-Axis, E-W Horiz Axis	Average	1.3	2.1	2.7	3.5	4.5	5.4	6.5	5.6	4.8	3.4	1.3	1.0	3.5
	Min/Max	0.4/2.7	0.7/3.6	1.2/4.2	2.2/4.9	3.2/5.8	4.0/7.0	4.9/7.4	3.6/7.1	3.5/6.2	1.7/5.0	0.6/2.5	0.3/1.9	2.6/3.9
1-Axis, N-S Horiz Axis	Average	0.9	1.7	2.9	4.4	6.0	7.1	8.7	7.3	5.7	3.2	1.0	0.6	4.2
	Min/Max	0.3/1.9	0.5/3.1	1.2/4.6	2.6/6.3	4.1/7.8	5.1/9.3	6.4/10.0	4.6/9.6	4.1/7.7	1.6/4.8	0.4/1.8	0.2/1.2	3.1/4.5
1-Axis, N-S Tilt=Latitude	Average	1.4	2.4	3.5	4.7	5.9	6.8	8.4	7.6	6.6	4.2	1.5	1.1	4.5
	Min/Max	0.4/2.9	0.8/4.3	1.5/5.6	2.8/6.8	4.0/7.7	4.8/8.8	6.2/9.7	4.8/9.8	4.8/8.7	2.1/6.2	0.6/2.7	0.3/2.0	3.3/5.0
2-Axis	Average	1.5	2.5	3.5	4.8	6.2	7.4	9.0	7.8	6.6	4.2	1.6	1.1	4.7
	Min/Max	0.4/3.1	0.8/4.4	1.5/5.6	2.8/6.9	4.3/8.1	5.2/9.6	6.7/10.4	4.9/10.1	4.8/8.8	2.1/6.3	0.6/2.9	0.4/2.1	3.5/5.2

**Average Climatic Conditions**

Element	Jan	Feb	Mar	Apr	May	June	July	Aug	Sept	Oct	Nov	Dec	Year
Temperature (°C)	3.4	6.0	8.3	10.7	14.6	19.2	22.7	22.5	18.6	12.7	6.7	3.2	12.4
Daily Minimum Temp	-0.9	0.1	1.9	3.3	6.3	10.4	12.9	12.8	9.0	4.7	1.9	-0.4	5.2
Daily Maximum Temp	7.6	11.8	14.7	18.1	22.7	27.8	32.5	32.2	28.2	20.8	11.4	6.8	19.6
Record Minimum Temp	-19.4	-14.4	-8.9	-6.1	-2.2	-0.6	3.3	3.9	-1.7	-7.8	-12.2	-21.1	-21.1
Record Maximum Temp	21.7	25.0	30.0	33.9	39.4	42.8	46.1	45.6	43.3	37.2	23.9	22.2	46.1
HDD, Base 18.3°C	463	346	310	231	122	33	4	6	52	178	348	468	2562
CDD, Base 18.3°C	0	0	0	0	4	58	141	136	60	4	0	0	403
Relative Humidity (%)	84	78	71	65	61	55	48	51	57	70	84	87	67
Wind Speed (m/s)	1.7	2.1	2.4	2.5	2.5	2.7	2.6	2.4	2.1	1.7	1.7	1.6	2.1



# North Bend, OR

WBAN NO. 24284

LATITUDE: 43.42° N  
 LONGITUDE: 124.25° W  
 ELEVATION: 5 meters  
 MEAN PRESSURE: 1018 millibars

STATION TYPE: Secondary

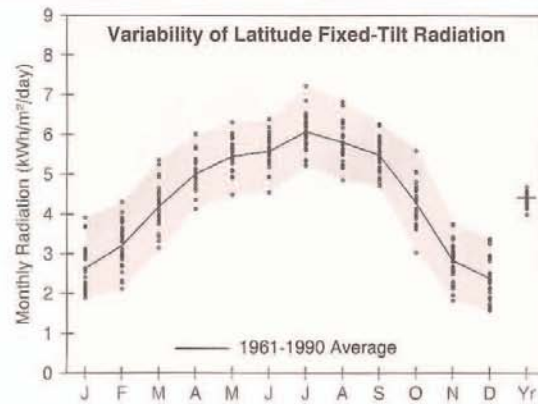

Solar Radiation for Flat-Plate Collectors Facing South at a Fixed Tilt (kWh/m<sup>2</sup>/day), Uncertainty ±9%

Tilt (°)		Jan	Feb	Mar	Apr	May	June	July	Aug	Sept	Oct	Nov	Dec	Year
0	Average	1.5	2.2	3.4	4.7	5.7	6.2	6.5	5.6	4.5	3.0	1.8	1.3	3.9
	Min/Max	1.3/1.9	1.7/2.6	2.8/4.1	4.0/5.4	4.8/6.5	5.1/7.1	5.6/7.7	4.8/6.4	4.0/5.0	2.4/3.6	1.4/2.1	1.0/1.6	3.6/4.0
Latitude -15	Average	2.4	3.0	4.1	5.1	5.8	6.1	6.5	6.0	5.4	4.0	2.6	2.1	4.4
	Min/Max	1.8/3.4	2.0/3.9	3.2/5.2	4.3/6.1	4.8/6.7	4.9/7.0	5.6/7.8	5.1/7.1	4.7/6.1	2.9/5.2	1.8/3.3	1.5/2.9	4.0/4.7
Latitude	Average	2.6	3.2	4.2	5.0	5.5	5.6	6.1	5.8	5.5	4.3	2.8	2.4	4.4
	Min/Max	1.9/3.9	2.1/4.3	3.2/5.4	4.1/6.0	4.5/6.3	4.6/6.4	5.2/7.2	4.8/6.8	4.7/6.3	3.0/5.6	1.8/3.8	1.6/3.4	4.0/4.7
Latitude +15	Average	2.7	3.3	4.1	4.6	4.8	4.8	5.3	5.3	5.2	4.3	2.9	2.5	4.2
	Min/Max	1.9/4.2	2.1/4.4	3.0/5.2	3.8/5.6	4.0/5.6	4.0/5.5	4.6/6.3	4.4/6.2	4.5/6.0	3.0/5.7	1.8/4.0	1.6/3.6	3.7/4.5
90	Average	2.5	2.8	3.1	3.1	2.9	2.7	3.0	3.3	3.8	3.6	2.6	2.3	3.0
	Min/Max	1.7/4.0	1.7/3.9	2.3/4.1	2.6/3.8	2.5/3.3	2.4/3.0	2.7/3.4	2.8/3.9	3.3/4.4	2.4/4.8	1.5/3.6	1.4/3.5	2.6/3.2

Solar Radiation for 1-Axis Tracking Flat-Plate Collectors with a North-South Axis (kWh/m<sup>2</sup>/day), Uncertainty ±9%

Axis Tilt (°)		Jan	Feb	Mar	Apr	May	June	July	Aug	Sept	Oct	Nov	Dec	Year
0	Average	2.1	2.9	4.4	6.0	7.2	7.8	8.4	7.3	6.2	4.1	2.4	1.8	5.1
	Min/Max	1.5/3.1	1.9/4.0	3.2/5.9	4.9/7.4	5.7/8.6	5.5/9.3	6.9/10.4	5.9/8.8	5.1/7.1	2.8/5.5	1.6/3.2	1.3/2.5	4.6/5.4
Latitude -15	Average	2.7	3.5	5.0	6.4	7.4	7.8	8.5	7.7	6.9	4.9	3.0	2.4	5.5
	Min/Max	1.9/4.2	2.2/4.9	3.5/6.7	5.2/8.0	5.8/8.9	5.5/9.4	7.0/10.6	6.2/9.4	5.7/8.0	3.3/6.7	1.9/4.1	1.6/3.5	4.9/5.9
Latitude	Average	3.0	3.7	5.0	6.3	7.2	7.5	8.2	7.6	7.0	5.1	3.2	2.7	5.5
	Min/Max	2.0/4.6	2.2/5.2	3.6/6.9	5.1/7.9	5.6/8.6	5.2/9.0	6.7/10.2	6.0/9.2	5.7/8.1	3.4/7.0	1.9/4.4	1.7/3.9	4.9/5.9
Latitude +15	Average	3.1	3.7	4.9	6.1	6.7	6.9	7.7	7.2	6.8	5.2	3.3	2.8	5.4
	Min/Max	2.0/4.8	2.2/5.3	3.5/6.8	4.8/7.6	5.2/8.1	4.8/8.4	6.2/9.6	5.7/8.8	5.6/7.9	3.3/7.1	1.9/4.6	1.7/4.1	4.7/5.8

Solar Radiation for 2-Axis Tracking Flat-Plate Collectors (kWh/m<sup>2</sup>/day), Uncertainty ±9%

Tracker		Jan	Feb	Mar	Apr	May	June	July	Aug	Sept	Oct	Nov	Dec	Year
2-Axis	Average	3.1	3.8	5.1	6.4	7.5	8.0	8.7	7.8	7.0	5.2	3.3	2.8	5.7
	Min/Max	2.1/4.9	2.3/5.3	3.6/6.9	5.2/8.0	5.8/9.0	5.6/9.6	7.1/10.8	6.2/9.4	5.8/8.1	3.4/7.1	1.9/4.6	1.7/4.2	5.1/6.1

Direct Beam Solar Radiation for Concentrating Collectors (kWh/m<sup>2</sup>/day), Uncertainty ±8%

Tracker		Jan	Feb	Mar	Apr	May	June	July	Aug	Sept	Oct	Nov	Dec	Year
1-Axis, E-W Horiz Axis	Average	1.7	1.9	2.3	2.8	3.4	3.8	4.5	4.0	3.7	2.8	1.8	1.6	2.9
	Min/Max	0.8/3.3	0.8/3.2	1.3/3.7	2.0/4.1	2.1/4.6	1.9/5.2	3.0/6.4	2.7/5.3	2.7/4.5	1.4/4.3	0.6/2.8	0.6/2.8	2.3/3.2
1-Axis, N-S Horiz Axis	Average	1.2	1.6	2.4	3.5	4.4	4.8	5.7	4.9	4.2	2.6	1.3	1.0	3.1
	Min/Max	0.5/2.3	0.6/2.7	1.3/4.1	2.5/5.0	2.7/5.9	2.3/6.7	3.8/8.1	3.3/6.6	3.1/5.2	1.2/4.1	0.4/2.2	0.4/1.8	2.6/3.5
1-Axis, N-S Tilt=Latitude	Average	1.8	2.2	3.0	3.8	4.4	4.6	5.6	5.1	4.9	3.5	2.0	1.7	3.5
	Min/Max	0.9/3.6	0.9/3.8	1.6/4.9	2.7/5.4	2.7/5.8	2.2/6.4	3.7/7.8	3.5/6.8	3.6/6.0	1.6/5.4	0.7/3.2	0.7/2.9	2.9/4.0
2-Axis	Average	2.0	2.3	3.0	3.8	4.6	5.0	6.0	5.3	4.9	3.5	2.1	1.8	3.7
	Min/Max	0.9/3.8	0.9/3.9	1.6/4.9	2.7/5.5	2.8/6.2	2.3/6.9	4.0/8.4	3.6/7.1	3.6/6.1	1.6/5.4	0.7/3.4	0.7/3.2	3.0/4.2

Average Climatic Conditions

Element	Jan	Feb	Mar	Apr	May	June	July	Aug	Sept	Oct	Nov	Dec	Year
Temperature (°C)	7.4	8.5	8.9	9.7	11.9	14.1	15.2	15.6	14.8	12.7	10.1	7.8	11.4
Daily Minimum Temp	3.8	4.7	5.1	5.8	8.1	10.4	11.4	11.7	10.3	8.2	6.2	4.3	7.5
Daily Maximum Temp	11.0	12.2	12.7	13.6	15.7	17.7	19.1	19.5	19.4	17.2	13.8	11.3	15.3
Record Minimum Temp	-7.2	-8.9	-2.8	-1.7	2.2	3.9	5.0	6.7	2.2	-1.7	-4.4	-10.6	-10.6
Record Maximum Temp	20.6	24.4	25.0	30.0	28.3	28.3	29.4	28.9	31.1	29.4	23.3	20.6	31.1
HDD, Base 18.3°C	338	276	293	258	200	128	97	87	108	174	248	326	2532
CDD, Base 18.3°C	0	0	0	0	0	0	0	0	0	0	0	0	0
Relative Humidity (%)	82	82	80	78	78	79	80	81	81	83	84	83	81
Wind Speed (m/s)	3.8	3.9	4.2	4.3	4.5	4.8	5.1	4.4	3.9	3.4	3.9	3.8	4.2



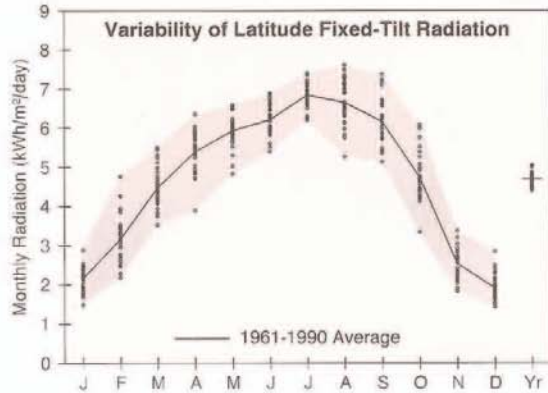

**Pendleton, OR**

**WBAN NO. 24155**

LATITUDE: 45.68° N  
 LONGITUDE: 118.85° W  
 ELEVATION: 456 meters  
 MEAN PRESSURE: 963 millibars

STATION TYPE: Secondary

**Solar Radiation for Flat-Plate Collectors Facing South at a Fixed Tilt (kWh/m<sup>2</sup>/day), Uncertainty ±9%**

Tilt (°)		Jan	Feb	Mar	Apr	May	June	July	Aug	Sept	Oct	Nov	Dec	Year
0	Average	1.4	2.1	3.4	4.9	6.2	6.9	7.4	6.3	4.8	3.0	1.6	1.1	4.1
	Min/Max	1.1/1.5	1.7/2.7	2.9/4.0	3.8/5.6	5.2/6.8	6.0/7.7	6.7/8.0	5.1/7.1	4.2/5.6	2.5/3.6	1.3/1.9	1.0/1.4	3.9/4.3
Latitude -15	Average	2.0	3.0	4.4	5.5	6.3	6.8	7.4	6.9	6.1	4.4	2.3	1.7	4.7
	Min/Max	1.5/2.5	2.1/4.3	3.5/5.3	4.0/6.4	5.2/7.0	5.9/7.5	6.7/8.0	5.5/7.9	5.1/7.2	3.2/5.6	1.7/3.0	1.4/2.5	4.5/5.0
Latitude	Average	2.2	3.2	4.5	5.4	5.9	6.2	6.8	6.7	6.2	4.7	2.5	1.9	4.7
	Min/Max	1.5/2.9	2.2/4.8	3.5/5.5	3.9/6.3	4.8/6.6	5.4/6.9	6.2/7.4	5.3/7.6	5.1/7.4	3.3/6.1	1.8/3.4	1.4/2.8	4.4/5.0
Latitude +15	Average	2.2	3.2	4.3	5.0	5.2	5.3	5.9	6.0	5.9	4.8	2.6	2.0	4.4
	Min/Max	1.5/3.0	2.1/4.9	3.4/5.4	3.6/5.9	4.3/5.8	4.7/5.9	5.4/6.4	4.8/6.9	4.9/7.1	3.3/6.2	1.8/3.5	1.4/3.1	4.1/4.7
90	Average	2.1	2.8	3.5	3.5	3.2	3.1	3.4	3.9	4.5	4.1	2.3	1.9	3.2
	Min/Max	1.3/2.9	1.8/4.4	2.6/4.4	2.5/4.1	2.7/3.5	2.8/3.3	3.2/3.6	3.2/4.4	3.7/5.4	2.8/5.3	1.6/3.3	1.3/3.0	3.0/3.5

**Solar Radiation for 1-Axis Tracking Flat-Plate Collectors with a North-South Axis (kWh/m<sup>2</sup>/day), Uncertainty ±9%**

Axis Tilt (°)		Jan	Feb	Mar	Apr	May	June	July	Aug	Sept	Oct	Nov	Dec	Year
0	Average	1.7	2.9	4.8	6.7	8.4	9.4	10.5	9.2	7.2	4.6	2.1	1.5	5.8
	Min/Max	1.3/2.2	2.0/4.2	3.8/6.0	4.7/8.0	6.7/9.6	7.8/10.9	8.9/11.6	7.0/10.9	5.7/8.9	3.2/5.9	1.5/2.8	1.2/2.1	5.3/6.1
Latitude -15	Average	2.2	3.5	5.5	7.2	8.6	9.5	10.7	9.8	8.2	5.6	2.7	1.9	6.3
	Min/Max	1.5/3.0	2.3/5.4	4.3/7.0	4.9/8.7	6.8/9.9	7.8/11.0	9.1/11.9	7.3/11.6	6.4/10.1	3.8/7.4	1.9/3.6	1.4/2.9	5.8/6.8
Latitude	Average	2.4	3.7	5.6	7.1	8.4	9.1	10.4	9.6	8.3	5.9	2.8	2.1	6.3
	Min/Max	1.5/3.3	2.4/5.8	4.3/7.2	4.8/8.7	6.6/9.6	7.5/10.6	8.8/11.5	7.2/11.5	6.5/10.3	3.9/7.8	2.0/3.9	1.5/3.2	5.8/6.8
Latitude +15	Average	2.4	3.7	5.5	6.9	7.9	8.6	9.8	9.2	8.1	5.9	2.9	2.2	6.1
	Min/Max	1.5/3.4	2.3/5.9	4.2/7.1	4.6/8.4	6.2/9.1	7.0/10.0	8.2/10.9	6.8/11.0	6.3/10.1	3.9/7.8	2.0/4.0	1.5/3.4	5.5/6.6

**Solar Radiation for 2-Axis Tracking Flat-Plate Collectors (kWh/m<sup>2</sup>/day), Uncertainty ±9%**

Tracker		Jan	Feb	Mar	Apr	May	June	July	Aug	Sept	Oct	Nov	Dec	Year
2-Axis	Average	2.5	3.7	5.6	7.3	8.8	9.7	10.9	9.8	8.3	5.9	2.9	2.2	6.5
	Min/Max	1.5/3.5	2.4/5.9	4.3/7.2	4.9/8.8	6.9/10.1	8.0/11.3	9.3/12.2	7.4/11.7	6.5/10.3	3.9/7.8	2.0/4.1	1.5/3.5	5.9/7.0

**Direct Beam Solar Radiation for Concentrating Collectors (kWh/m<sup>2</sup>/day), Uncertainty ±8%**

Tracker		Jan	Feb	Mar	Apr	May	June	July	Aug	Sept	Oct	Nov	Dec	Year
1-Axis, E-W Horiz Axis	Average	1.1	1.7	2.6	3.3	4.2	4.9	6.0	5.3	4.5	3.4	1.4	1.0	3.3
	Min/Max	0.4/2.0	0.6/3.5	1.6/3.8	1.7/4.5	2.8/5.2	3.6/6.4	4.6/7.1	3.3/6.8	3.0/6.1	1.7/5.0	0.6/2.3	0.5/2.0	2.9/3.8
1-Axis, N-S Horiz Axis	Average	0.7	1.5	2.9	4.2	5.6	6.5	8.1	7.0	5.4	3.2	1.0	0.6	3.9
	Min/Max	0.3/1.3	0.5/3.0	1.9/4.3	2.2/5.7	3.8/7.0	4.8/8.5	5.9/9.5	4.3/9.1	3.5/7.4	1.6/4.7	0.4/1.7	0.3/1.2	3.3/4.4
1-Axis, N-S Tilt=Latitude	Average	1.2	2.1	3.5	4.6	5.5	6.3	7.8	7.3	6.3	4.3	1.6	1.1	4.3
	Min/Max	0.4/2.2	0.8/4.2	2.3/5.2	2.4/6.2	3.8/7.0	4.6/8.1	5.8/9.3	4.5/9.5	4.1/8.6	2.2/6.3	0.6/2.6	0.5/2.1	3.7/4.9
2-Axis	Average	1.3	2.1	3.5	4.7	5.8	6.8	8.4	7.5	6.3	4.3	1.7	1.2	4.5
	Min/Max	0.4/2.3	0.8/4.3	2.3/5.2	2.4/6.3	4.0/7.3	5.0/8.9	6.2/9.9	4.7/9.8	4.1/8.6	2.2/6.4	0.7/2.8	0.5/2.3	3.8/5.1

**Average Climatic Conditions**

Element	Jan	Feb	Mar	Apr	May	June	July	Aug	Sept	Oct	Nov	Dec	Year
Temperature (°C)	0.8	4.0	7.1	10.2	14.4	19.0	22.7	22.2	17.3	11.3	5.3	1.3	11.3
Daily Minimum Temp	-2.7	-0.2	1.9	4.1	7.7	11.6	14.4	14.3	9.9	5.0	1.2	-2.3	5.4
Daily Maximum Temp	4.3	8.3	12.3	16.3	21.1	26.4	31.0	30.1	24.6	17.6	9.4	4.7	17.2
Record Minimum Temp	-30.0	-27.8	-12.2	-7.8	-3.9	1.7	5.6	4.4	-1.1	-11.7	-24.4	-28.3	-30.0
Record Maximum Temp	20.0	22.2	26.1	32.8	37.8	42.2	43.3	45.0	38.9	33.3	25.0	19.4	45.0
HDD, Base 18.3°C	543	401	348	245	126	39	8	13	81	217	392	529	2941
CDD, Base 18.3°C	0	0	0	0	3	59	144	133	49	0	0	0	389
Relative Humidity (%)	77	73	63	58	52	46	36	39	47	59	74	78	58
Wind Speed (m/s)	3.3	3.4	3.8	4.1	3.9	3.8	3.7	3.5	3.4	3.1	3.2	3.1	3.5

# Portland, OR

WBAN NO. 24229

LATITUDE: 45.60° N  
 LONGITUDE: 122.60° W  
 ELEVATION: 12 meters  
 MEAN PRESSURE: 1017 millibars

STATION TYPE: Primary

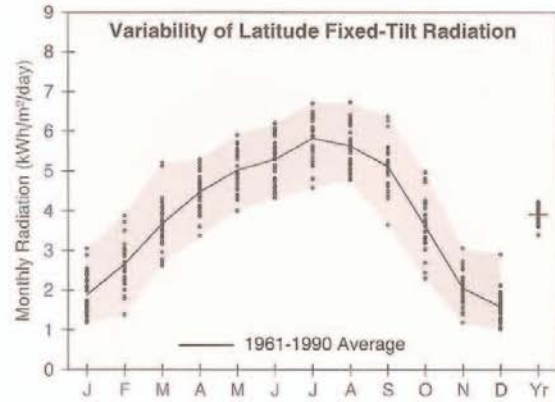

Solar Radiation for Flat-Plate Collectors Facing South at a Fixed Tilt (kWh/m<sup>2</sup>/day), Uncertainty ±9%

Tilt (°)		Jan	Feb	Mar	Apr	May	June	July	Aug	Sept	Oct	Nov	Dec	Year
0	Average	1.2	1.9	3.0	4.2	5.3	5.9	6.3	5.4	4.1	2.5	1.4	1.0	3.5
	Min/Max	0.9/1.5	1.4/2.4	2.4/3.8	3.4/4.8	4.3/6.2	4.8/6.9	5.0/7.2	4.6/6.3	3.2/4.9	1.8/3.2	0.9/1.7	0.7/1.3	3.1/3.8
Latitude -15	Average	1.7	2.5	3.6	4.6	5.4	5.8	6.3	5.9	5.1	3.4	1.9	1.4	4.0
	Min/Max	1.1/2.7	1.4/3.6	2.7/5.0	3.5/5.4	4.3/6.3	4.7/6.8	4.9/7.2	5.0/7.0	3.7/6.2	2.3/4.6	1.1/2.8	1.0/2.5	3.5/4.3
Latitude	Average	1.9	2.6	3.7	4.5	5.0	5.3	5.8	5.6	5.1	3.6	2.1	1.6	3.9
	Min/Max	1.2/3.0	1.4/3.9	2.6/5.2	3.4/5.3	4.0/5.9	4.3/6.2	4.6/6.7	4.8/6.7	3.6/6.4	2.3/5.0	1.2/3.1	1.0/2.9	3.4/4.2
Latitude +15	Average	1.9	2.7	3.5	4.1	4.4	4.6	5.1	5.1	4.9	3.6	2.1	1.6	3.6
	Min/Max	1.2/3.2	1.3/4.0	2.5/5.1	3.1/4.9	3.5/5.2	3.8/5.3	4.0/5.8	4.3/6.1	3.4/6.1	2.2/5.0	1.2/3.2	1.0/3.1	3.2/3.9
90	Average	1.8	2.3	2.8	2.9	2.8	2.7	3.1	3.4	3.7	3.0	1.9	1.5	2.6
	Min/Max	1.0/3.1	1.0/3.5	1.9/4.1	2.2/3.5	2.3/3.3	2.3/3.1	2.5/3.4	2.9/4.0	2.6/4.7	1.8/4.3	1.0/2.9	0.9/3.0	2.3/2.9

Solar Radiation for 1-Axis Tracking Flat-Plate Collectors with a North-South Axis (kWh/m<sup>2</sup>/day), Uncertainty ±9%

Axis Tilt (°)		Jan	Feb	Mar	Apr	May	June	July	Aug	Sept	Oct	Nov	Dec	Year
0	Average	1.5	2.4	3.8	5.2	6.6	7.4	8.3	7.3	5.7	3.4	1.7	1.2	4.5
	Min/Max	0.9/2.3	1.3/3.4	2.7/5.4	3.7/6.4	4.8/8.0	5.8/9.2	6.1/9.9	5.7/9.0	3.8/7.2	2.2/4.7	1.0/2.4	0.8/2.0	3.9/5.0
Latitude -15	Average	1.9	2.9	4.3	5.6	6.8	7.5	8.4	7.7	6.4	4.1	2.1	1.6	4.9
	Min/Max	1.1/3.2	1.4/4.3	2.9/6.3	3.9/6.9	4.9/8.3	5.8/9.3	6.1/10.1	6.1/9.6	4.2/8.2	2.5/5.8	1.2/3.2	1.0/2.9	4.2/5.4
Latitude	Average	2.0	3.0	4.3	5.5	6.5	7.2	8.1	7.5	6.5	4.3	2.2	1.7	4.9
	Min/Max	1.2/3.5	1.4/4.6	2.9/6.4	3.8/6.8	4.7/8.0	5.6/8.9	5.8/9.8	5.9/9.5	4.2/8.4	2.5/6.1	1.2/3.5	1.0/3.3	4.2/5.4
Latitude +15	Average	2.1	3.0	4.2	5.3	6.1	6.7	7.6	7.2	6.3	4.2	2.3	1.7	4.7
	Min/Max	1.2/3.6	1.3/4.6	2.8/6.3	3.6/6.5	4.4/7.5	5.2/8.3	5.5/9.2	5.6/9.0	4.0/8.2	2.5/6.1	1.2/3.6	1.0/3.4	4.0/5.2

Solar Radiation for 2-Axis Tracking Flat-Plate Collectors (kWh/m<sup>2</sup>/day), Uncertainty ±9%

Tracker		Jan	Feb	Mar	Apr	May	June	July	Aug	Sept	Oct	Nov	Dec	Year
2-Axis	Average	2.1	3.0	4.4	5.6	6.9	7.7	8.6	7.7	6.5	4.3	2.3	1.8	5.1
	Min/Max	1.2/3.7	1.4/4.7	2.9/6.4	3.9/6.9	5.0/8.4	6.0/9.5	6.2/10.3	6.1/9.7	4.2/8.4	2.5/6.1	1.3/3.6	1.0/3.5	4.3/5.6

Direct Beam Solar Radiation for Concentrating Collectors (kWh/m<sup>2</sup>/day), Uncertainty ±8%

Tracker		Jan	Feb	Mar	Apr	May	June	July	Aug	Sept	Oct	Nov	Dec	Year
1-Axis, E-W Horiz Axis	Average	1.0	1.4	1.9	2.2	2.8	3.4	4.2	3.8	3.3	2.2	1.1	0.8	2.3
	Min/Max	0.2/2.4	0.2/2.7	0.9/3.4	1.1/3.1	1.4/3.9	2.2/4.8	2.2/6.0	2.5/5.2	1.5/4.7	0.9/3.6	0.4/2.2	0.2/2.2	1.9/2.9
1-Axis, N-S Horiz Axis	Average	0.6	1.1	1.9	2.7	3.6	4.4	5.4	4.8	3.7	2.0	0.7	0.5	2.6
	Min/Max	0.2/1.5	0.2/2.2	0.9/3.7	1.3/3.8	1.8/5.1	2.9/6.3	2.9/8.1	3.1/6.7	1.6/5.3	0.8/3.3	0.3/1.4	0.1/1.3	2.1/3.2
1-Axis, N-S Tilt=Latitude	Average	1.1	1.6	2.4	3.0	3.6	4.2	5.3	5.0	4.4	2.7	1.2	0.9	3.0
	Min/Max	0.3/2.6	0.2/3.2	1.1/4.5	1.4/4.2	1.8/5.1	2.7/6.1	2.8/7.8	3.3/7.0	1.9/6.3	1.1/4.4	0.5/2.3	0.2/2.3	2.3/3.6
2-Axis	Average	1.2	1.7	2.4	3.0	3.8	4.5	5.7	5.2	4.4	2.7	1.3	0.9	3.1
	Min/Max	0.3/2.7	0.2/3.2	1.1/4.5	1.4/4.3	1.9/5.4	3.0/6.6	3.0/8.4	3.4/7.3	2.0/6.3	1.1/4.5	0.5/2.5	0.2/2.5	2.4/3.8

Average Climatic Conditions

Element	Jan	Feb	Mar	Apr	May	June	July	Aug	Sept	Oct	Nov	Dec	Year
Temperature (°C)	4.2	6.4	8.5	10.6	13.9	17.5	20.1	20.3	17.4	12.5	7.8	4.6	12.0
Daily Minimum Temp	0.9	2.3	3.7	5.2	8.3	11.6	13.6	13.8	11.1	7.2	4.2	1.6	6.9
Daily Maximum Temp	7.4	10.6	13.3	15.9	19.5	23.3	26.6	26.8	23.7	17.8	11.4	7.6	17.0
Record Minimum Temp	-18.9	-19.4	-7.2	-1.7	-1.7	3.9	6.1	6.7	1.1	-3.3	-10.6	-14.4	-19.4
Record Maximum Temp	17.2	21.7	26.7	30.6	37.8	37.8	41.7	41.7	40.6	33.3	22.8	17.8	41.7
HDD, Base 18.3°C	437	333	305	233	138	51	16	19	57	181	315	427	2512
CDD, Base 18.3°C	0	0	0	0	0	26	71	82	28	0	0	0	206
Relative Humidity (%)	81	78	75	72	69	66	63	65	69	78	82	83	73
Wind Speed (m/s)	4.4	4.2	3.8	3.4	3.4	3.4	3.5	3.3	3.1	3.0	4.0	4.2	3.6



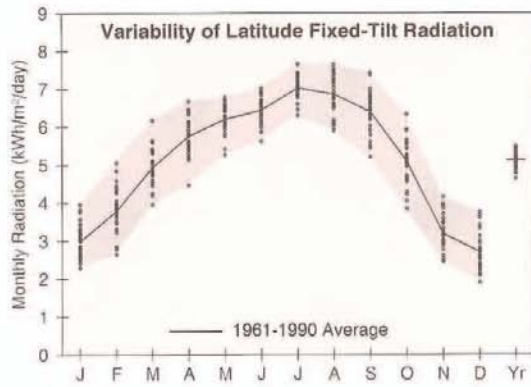

**Redmond, OR**

**WBAN NO. 24230**

LATITUDE: 44.27° N  
 LONGITUDE: 121.15° W  
 ELEVATION: 940 meters  
 MEAN PRESSURE: 909 millibars

STATION TYPE: Primary

**Solar Radiation for Flat-Plate Collectors Facing South at a Fixed Tilt (kWh/m²/day), Uncertainty ±9%**

Tilt (°)		Jan	Feb	Mar	Apr	May	June	July	Aug	Sept	Oct	Nov	Dec	Year
0	Average	1.7	2.5	3.8	5.3	6.5	7.2	7.6	6.6	5.1	3.3	1.9	1.4	4.4
	Min/Max	1.4/1.9	1.9/3.0	3.2/4.4	4.3/5.9	5.6/7.1	6.3/7.8	6.8/8.4	5.6/7.2	4.4/5.7	2.8/3.9	1.6/2.2	1.2/1.7	4.1/4.6
Latitude -15	Average	2.6	3.5	4.8	5.9	6.6	7.0	7.6	7.1	6.3	4.7	2.9	2.4	5.1
	Min/Max	2.1/3.4	2.5/4.6	3.9/5.9	4.6/6.8	5.6/7.2	6.1/7.7	6.8/8.3	6.1/7.9	5.2/7.3	3.7/5.8	2.3/3.7	1.7/3.2	4.7/5.5
Latitude	Average	3.0	3.8	4.9	5.7	6.2	6.4	7.0	6.9	6.4	5.1	3.2	2.7	5.1
	Min/Max	2.3/4.0	2.7/5.1	4.0/6.2	4.5/6.7	5.3/6.8	5.6/7.0	6.3/7.7	5.9/7.6	5.2/7.4	3.8/6.3	2.4/4.2	1.9/3.8	4.6/5.5
Latitude +15	Average	3.1	3.9	4.8	5.3	5.5	5.5	6.1	6.2	6.1	5.1	3.3	2.9	4.8
	Min/Max	2.4/4.2	2.7/5.2	3.8/6.1	4.1/6.2	4.6/5.9	4.8/6.0	5.5/6.6	5.4/6.9	4.9/7.2	3.8/6.5	2.5/4.4	2.0/4.1	4.3/5.2
90	Average	2.9	3.4	3.8	3.7	3.3	3.1	3.4	3.9	4.5	4.3	3.0	2.7	3.5
	Min/Max	2.2/4.0	2.3/4.6	3.0/4.9	2.8/4.2	2.9/3.5	2.8/3.3	3.1/3.6	3.5/4.3	3.6/5.3	3.2/5.5	2.2/4.0	1.9/3.9	3.1/3.8

**Solar Radiation for 1-Axis Tracking Flat-Plate Collectors with a North-South Axis (kWh/m²/day), Uncertainty ±9%**

Axis Tilt (°)		Jan	Feb	Mar	Apr	May	June	July	Aug	Sept	Oct	Nov	Dec	Year
0	Average	2.4	3.4	5.3	7.2	8.8	9.9	10.8	9.5	7.6	5.0	2.6	2.0	6.2
	Min/Max	1.9/3.1	2.4/4.6	4.1/6.5	5.5/8.5	7.2/10.0	8.2/11.1	9.0/12.5	7.7/10.9	6.1/9.0	3.7/6.2	2.0/3.4	1.5/2.7	5.5/6.7
Latitude -15	Average	3.1	4.2	6.0	7.7	9.1	9.9	11.0	10.1	8.5	6.1	3.4	2.7	6.8
	Min/Max	2.4/4.2	2.8/5.8	4.6/7.6	5.8/9.2	7.3/10.3	8.2/11.2	9.2/12.7	8.1/11.6	6.8/10.2	4.4/7.7	2.5/4.5	1.9/3.9	6.0/7.4
Latitude	Average	3.4	4.4	6.2	7.7	8.8	9.5	10.6	9.9	8.6	6.3	3.6	3.0	6.9
	Min/Max	2.5/4.7	3.0/6.2	4.7/7.9	5.7/9.2	7.1/10.0	7.9/10.8	8.9/12.3	8.0/11.4	6.8/10.4	4.5/8.1	2.7/4.9	2.0/4.3	6.0/7.5
Latitude +15	Average	3.5	4.5	6.1	7.4	8.3	8.9	10.0	9.5	8.4	6.4	3.7	3.2	6.7
	Min/Max	2.6/4.9	3.0/6.3	4.6/7.8	5.4/8.8	6.7/9.4	7.4/10.1	8.3/11.6	7.6/10.9	6.6/10.2	4.5/8.2	2.8/5.1	2.1/4.6	5.8/7.3

**Solar Radiation for 2-Axis Tracking Flat-Plate Collectors (kWh/m²/day), Uncertainty ±9%**

Tracker		Jan	Feb	Mar	Apr	May	June	July	Aug	Sept	Oct	Nov	Dec	Year
2-Axis	Average	3.6	4.5	6.2	7.8	9.2	10.2	11.2	10.1	8.6	6.4	3.8	3.2	7.1
	Min/Max	2.6/4.9	3.0/6.3	4.7/7.9	5.8/9.3	7.4/10.4	8.4/11.5	9.3/13.0	8.2/11.7	6.8/10.4	4.6/8.2	2.8/5.1	2.1/4.7	6.2/7.7

**Direct Beam Solar Radiation for Concentrating Collectors (kWh/m²/day), Uncertainty ±8%**

Tracker		Jan	Feb	Mar	Apr	May	June	July	Aug	Sept	Oct	Nov	Dec	Year
1-Axis, E-W Horiz Axis	Average	1.9	2.3	2.9	3.5	4.4	5.2	6.2	5.4	4.7	3.6	2.0	1.8	3.7
	Min/Max	1.3/3.3	1.1/3.8	1.9/4.5	2.1/4.8	2.7/5.4	3.7/6.4	4.6/7.7	3.8/6.8	3.1/6.1	2.1/5.2	1.2/3.3	0.8/3.2	3.0/4.2
1-Axis, N-S Horiz Axis	Average	1.3	1.9	3.2	4.5	5.9	6.9	8.3	7.2	5.6	3.5	1.5	1.1	4.3
	Min/Max	0.8/2.2	0.9/3.2	2.0/4.7	2.8/6.1	3.7/7.2	4.9/8.6	5.9/10.5	5.0/9.1	3.8/7.5	1.9/4.9	0.9/2.4	0.5/2.0	3.4/4.8
1-Axis, N-S Tilt=Latitude	Average	2.1	2.8	3.9	4.9	5.8	6.6	8.0	7.5	6.5	4.6	2.3	1.9	4.7
	Min/Max	1.4/3.6	1.3/4.6	2.4/5.9	3.0/6.6	3.7/7.2	4.7/8.2	5.7/10.2	5.2/9.4	4.4/8.6	2.6/6.5	1.4/3.7	0.9/3.3	3.8/5.4
2-Axis	Average	2.3	2.8	3.9	5.0	6.1	7.1	8.6	7.7	6.5	4.7	2.4	2.1	4.9
	Min/Max	1.5/3.8	1.3/4.7	2.4/5.9	3.0/6.7	3.9/7.6	5.1/8.9	6.2/11.0	5.4/9.7	4.4/8.6	2.6/6.6	1.4/3.9	0.9/3.6	4.0/5.6

**Average Climatic Conditions**

Element	Jan	Feb	Mar	Apr	May	June	July	Aug	Sept	Oct	Nov	Dec	Year
Temperature (°C)	-0.3	2.2	4.2	6.7	10.6	15.2	18.8	18.4	13.9	9.1	3.4	-0.1	8.5
Daily Minimum Temp	-5.9	-3.9	-3.2	-1.7	1.5	5.6	8.0	7.9	3.7	0.1	-2.6	-5.7	0.3
Daily Maximum Temp	5.1	8.4	11.5	15.1	19.6	24.8	29.6	28.8	24.1	17.9	9.4	5.4	16.7
Record Minimum Temp	-31.7	-27.8	-16.7	-11.1	-10.0	-3.3	-0.6	-0.6	-7.2	-15.0	-20.6	-31.7	-31.7
Record Maximum Temp	18.3	21.7	26.1	30.0	36.7	38.0	38.9	40.6	36.7	32.8	23.9	18.9	40.6
HDD, Base 18.3°C	579	451	439	348	241	107	44	53	146	288	447	572	3716
CDD, Base 18.3°C	0	0	0	0	0	14	60	55	13	0	0	0	142
Relative Humidity (%)	72	68	61	57	54	51	45	48	52	59	71	73	59
Wind Speed (m/s)	3.3	3.5	3.6	3.6	3.5	3.4	3.3	3.1	3.0	3.0	3.3	3.1	3.3

**Salem, OR**

**WBAN NO. 24232**

LATITUDE: 44.92° N  
 LONGITUDE: 123.02° W  
 ELEVATION: 61 meters  
 MEAN PRESSURE: 1011 millibars

STATION TYPE: Secondary

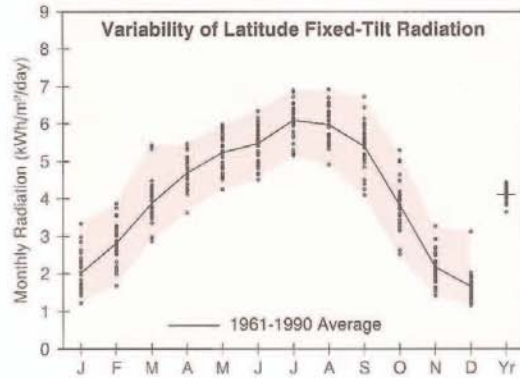

**Solar Radiation for Flat-Plate Collectors Facing South at a Fixed Tilt (kWh/m<sup>2</sup>/day), Uncertainty ±9%**

Tilt (°)		Jan	Feb	Mar	Apr	May	June	July	Aug	Sept	Oct	Nov	Dec	Year
0	Average	1.3	2.0	3.1	4.4	5.5	6.1	6.6	5.7	4.4	2.7	1.4	1.1	3.7
	Min/Max	1.0/1.7	1.5/2.5	2.5/3.9	3.5/5.0	4.5/6.2	5.1/7.0	5.5/7.4	4.9/6.5	3.5/5.2	2.0/3.3	1.1/1.8	0.9/1.4	3.4/3.9
Latitude -15	Average	1.8	2.7	3.8	4.8	5.6	6.0	6.6	6.2	5.3	3.6	2.0	1.5	4.2
	Min/Max	1.2/2.9	1.7/3.6	2.9/5.2	3.8/5.6	4.5/6.4	4.9/6.9	5.6/7.5	5.2/7.2	4.1/6.6	2.5/4.9	1.4/2.9	1.1/2.7	3.7/4.4
Latitude	Average	2.0	2.8	3.9	4.7	5.2	5.5	6.1	6.0	5.4	3.8	2.2	1.6	4.1
	Min/Max	1.2/3.3	1.7/3.9	2.9/5.4	3.6/5.5	4.2/6.0	4.5/6.3	5.2/6.9	4.9/6.9	4.1/6.7	2.5/5.3	1.4/3.3	1.2/3.1	3.6/4.4
Latitude +15	Average	2.1	2.8	3.7	4.3	4.6	4.7	5.3	5.4	5.1	3.8	2.2	1.7	3.8
	Min/Max	1.2/3.5	1.6/3.9	2.7/5.3	3.3/5.1	3.8/5.3	3.9/5.4	4.5/6.0	4.4/6.3	3.9/6.5	2.4/5.4	1.4/3.4	1.1/3.3	3.4/4.2
90	Average	1.9	2.4	2.9	3.0	2.9	2.8	3.1	3.5	3.9	3.2	1.9	1.5	2.8
	Min/Max	1.0/3.3	1.3/3.4	2.1/4.3	2.3/3.5	2.4/3.2	2.4/3.1	2.8/3.4	3.0/4.1	2.9/4.9	2.0/4.6	1.2/3.1	1.0/3.2	2.4/3.1

**Solar Radiation for 1-Axis Tracking Flat-Plate Collectors with a North-South Axis (kWh/m<sup>2</sup>/day), Uncertainty ±9%**

Axis Tilt (°)		Jan	Feb	Mar	Apr	May	June	July	Aug	Sept	Oct	Nov	Dec	Year
0	Average	1.6	2.5	4.0	5.6	7.0	7.9	8.9	7.9	6.1	3.7	1.8	1.3	4.9
	Min/Max	1.0/2.5	1.6/3.4	2.9/5.7	4.1/6.6	5.2/8.2	6.2/9.5	6.8/10.6	6.1/9.2	4.3/7.8	2.5/5.1	1.2/2.6	0.9/2.2	4.2/5.2
Latitude -15	Average	2.0	3.0	4.6	6.0	7.2	7.9	9.1	8.3	6.9	4.4	2.2	1.6	5.3
	Min/Max	1.2/3.5	1.7/4.3	3.2/6.6	4.3/7.1	5.3/8.4	6.1/9.6	6.9/10.8	6.4/9.8	4.8/8.9	2.8/6.3	1.4/3.4	1.1/3.2	4.6/5.7
Latitude	Average	2.2	3.2	4.6	5.9	7.0	7.6	8.7	8.2	7.0	4.5	2.4	1.8	5.3
	Min/Max	1.2/3.8	1.7/4.5	3.2/6.7	4.2/7.1	5.1/8.2	5.9/9.2	6.6/10.4	6.3/9.7	4.8/9.1	2.8/6.6	1.5/3.7	1.2/3.5	4.5/5.7
Latitude +15	Average	2.3	3.2	4.5	5.6	6.6	7.1	8.2	7.8	6.8	4.5	2.4	1.8	5.1
	Min/Max	1.2/4.0	1.7/4.6	3.1/6.7	4.0/6.8	4.8/7.7	5.5/8.6	6.2/9.8	5.9/9.2	4.7/8.9	2.8/6.6	1.5/3.9	1.2/3.7	4.3/5.5

**Solar Radiation for 2-Axis Tracking Flat-Plate Collectors (kWh/m<sup>2</sup>/day), Uncertainty ±9%**

Tracker		Jan	Feb	Mar	Apr	May	June	July	Aug	Sept	Oct	Nov	Dec	Year
2-Axis	Average	2.3	3.2	4.7	6.0	7.3	8.1	9.2	8.4	7.0	4.6	2.4	1.8	5.4
	Min/Max	1.2/4.0	1.7/4.6	3.2/6.8	4.3/7.2	5.4/8.6	6.3/9.8	7.0/11.0	6.4/9.9	4.9/9.1	2.9/6.6	1.5/3.9	1.2/3.8	4.6/5.9

**Direct Beam Solar Radiation for Concentrating Collectors (kWh/m<sup>2</sup>/day), Uncertainty ±8%**

Tracker		Jan	Feb	Mar	Apr	May	June	July	Aug	Sept	Oct	Nov	Dec	Year
1-Axis, E-W Horiz Axis	Average	1.1	1.5	2.0	2.4	3.1	3.6	4.6	4.1	3.5	2.3	1.1	0.8	2.5
	Min/Max	0.4/2.5	0.4/2.6	1.1/3.6	1.3/3.3	1.7/4.1	2.2/5.0	2.7/5.9	2.6/5.3	1.9/5.1	1.0/4.0	0.6/2.3	0.2/2.5	2.0/2.9
1-Axis, N-S Horiz Axis	Average	0.7	1.2	2.1	3.0	4.1	4.8	6.1	5.4	4.1	2.2	0.8	0.5	2.9
	Min/Max	0.2/1.7	0.3/2.1	1.1/3.8	1.6/4.1	2.2/5.3	2.9/6.6	3.5/7.9	3.3/7.0	2.0/6.0	0.9/3.7	0.4/1.6	0.1/1.4	2.3/3.3
1-Axis, N-S Tilt=Latitude	Average	1.2	1.7	2.6	3.3	4.0	4.6	5.9	5.6	4.8	2.9	1.3	0.9	3.2
	Min/Max	0.4/2.7	0.5/3.0	1.4/4.7	1.7/4.4	2.2/5.3	2.8/6.3	3.4/7.7	3.5/7.2	2.4/7.0	1.3/4.9	0.6/2.5	0.3/2.5	2.5/3.7
2-Axis	Average	1.3	1.8	2.6	3.4	4.3	5.0	6.4	5.8	4.8	2.9	1.3	1.0	3.4
	Min/Max	0.4/2.9	0.5/3.1	1.4/4.7	1.7/4.5	2.3/5.6	3.0/6.8	3.7/8.2	3.6/7.5	2.5/7.0	1.3/5.0	0.6/2.7	0.3/2.7	2.6/3.8

**Average Climatic Conditions**

Element	Jan	Feb	Mar	Apr	May	June	July	Aug	Sept	Oct	Nov	Dec	Year
Temperature (°C)	4.2	6.0	7.6	9.5	12.6	16.3	19.1	19.3	16.4	11.5	7.2	4.4	11.2
Daily Minimum Temp	0.4	1.2	2.0	3.2	5.7	9.1	10.5	10.8	8.4	5.1	3.1	0.9	5.0
Daily Maximum Temp	8.0	10.8	13.2	15.8	19.4	23.6	27.6	27.8	24.4	17.9	11.3	8.0	17.3
Record Minimum Temp	-23.3	-20.0	-11.1	-5.0	-3.9	0.0	2.8	2.2	-3.3	-5.0	-12.8	-24.4	-24.4
Record Maximum Temp	18.3	22.2	26.7	31.1	37.8	38.9	42.2	42.2	40.0	33.9	22.2	18.9	42.2
HDD, Base 18.3°C	437	346	332	265	179	78	23	29	73	212	333	431	2737
CDD, Base 18.3°C	0	0	0	0	0	18	45	58	16	0	0	0	137
Relative Humidity (%)	83	82	77	74	71	68	63	64	69	79	85	85	75
Wind Speed (m/s)	3.5	3.5	3.6	3.3	3.0	3.0	3.0	2.8	2.7	2.6	3.6	3.4	3.2



## APPENDIX E: NREL Approach to Determining Solar Insolation Values

PVWATTS v.2 (Beta) FlexViewer can be used as a quick way to determine site specific solar insolation (peak sun hours) data for specific locations within the 48 contiguous states, Alaska, and Hawaii.

Below is a brief summary of how to get started with PVWATTS v.2 (Beta) FlexViewer. (Additional instructions can be found on NREL's website at [http://mapserve3.nrel.gov/PVWatts\\_FlexViewer/index.html](http://mapserve3.nrel.gov/PVWatts_FlexViewer/index.html).)

- 1) Perform an internet search for "NREL PVWATTS FlexViewer (Beta)."
- 2) A screen with an interactive map highlighting the 48 contiguous states with a black box in the upper right-hand corner titled "PVWatts Tool" will come up, as shown in Figure C1, below.
- 3) Either select a location by clicking on the map or input the zip code for the area of interest in the black box and press "Go."

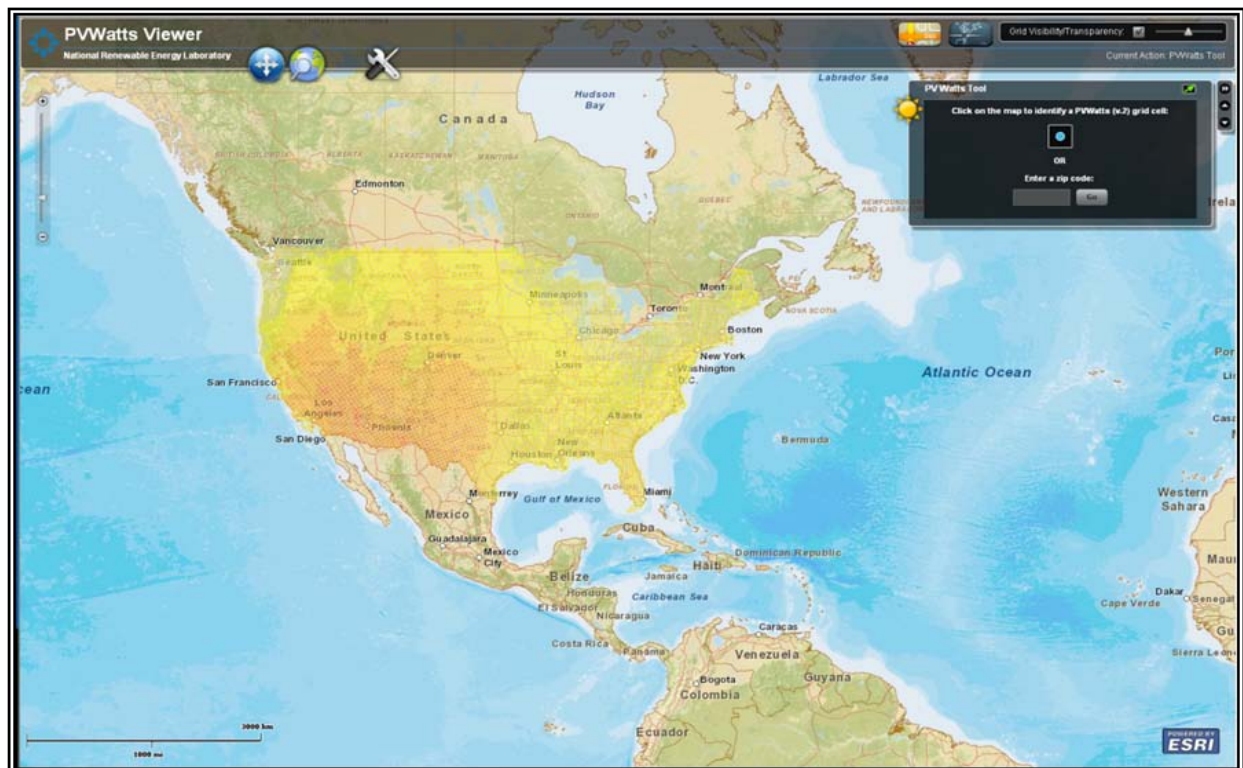

Figure C 1

PVWATTS will locate the site and populate the black box with pertinent information regarding the selected location, as shown in Figure C2, below. If the information is correct, press “Send to PVWATTS.” If not, press “Back” and choose again.

- 4) After your press “Send to PVWATTS,” you will be directed to the PVWATTS calculator site, as shown in Figure C3, on the following page. The PVWATTS calculator is partitioned into three distinct categories: Site Location, PV System Specifications, and Energy Data. In order to determine the solar insolation values for your site, you will only

need to input information under the PV System Specifications category for “Array Type” and “Array Tilt.”

**Array Type:** Select either “fixed,” “1-axis tracking,” or “2-axis tracking.”

**Array Tilt:** See Section 3.1 of this technical note to determine the correct tilt angle.

All other items in the calculator can be left with the default values.

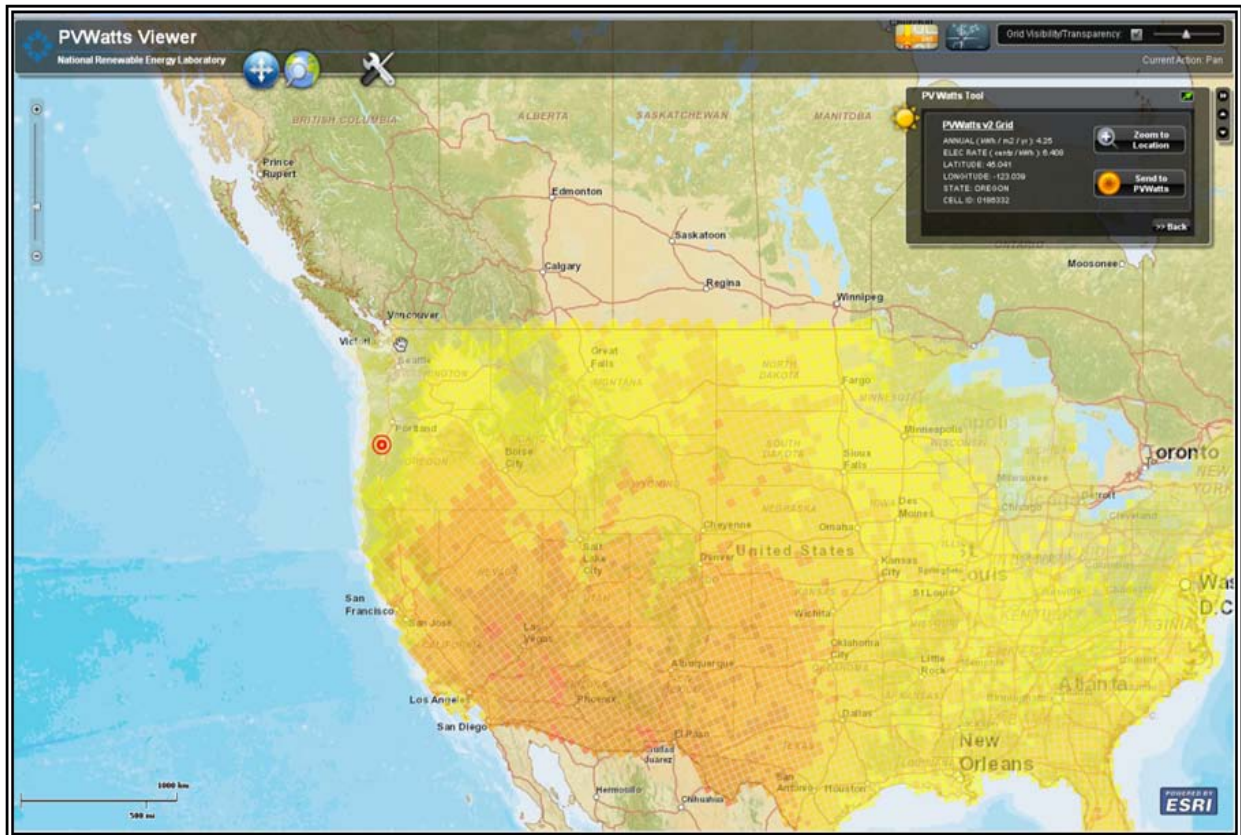

Figure C 2

**PV Walls**

Click on **Calculate** if default values are acceptable, or after selecting your system specifications. Click on **Help** for information about system specifications. To use a DC to AC derate factor other than the default, click on **Derate Factor Help** for information.

---

**Site Location:**

Cell ID: 0186332  
 State: Oregon  
 Latitude: 45.041  
 Longitude: -123.039

---

**PV System Specifications:**

DC Rating (kW):   
 DC to AC Derate Factor:  **DERATE FACTOR HELP**  
 Array Type:    
 Fixed Tilt or 1-Axis Tracking System:  
 Array Tilt (degrees):  (Default = Latitude)  
 Array Azimuth (degrees):  (Default = South)

---

**Energy Data:**

Cost of Electricity (cents/kWh):

---

Figure C 3

- 5) Press "Calculate." The PVWATTS calculator will provide a table listing monthly solar radiation (insolation) values, as shown in Figure C4, on the following page. It is always a good practice to compare these values with the solar insolation tables in

Appendix D or with other solar insolation values to make sure you are using the correct design values for your site.

Additional information regarding the use of PVWATTS can be obtained from the NREL website.

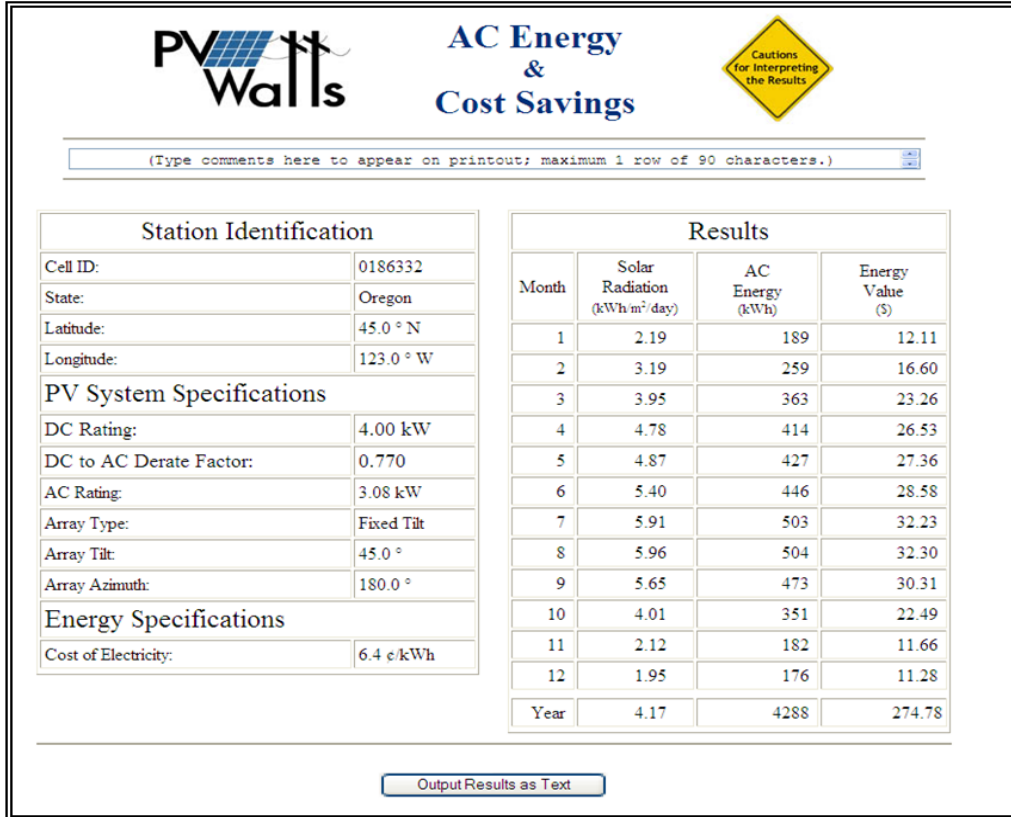

Figure C 4



# APPENDIX F: Standard Drawings

**SOLAR POWERED SUBMERSIBLE PUMP FOR WELL**

**PV SYSTEM INFORMATION**

**PUMP<sup>1</sup>**  
 \_\_\_\_\_ watts \_\_\_\_\_ design spin  
 \_\_\_\_\_ amps \_\_\_\_\_ manufacturer (or approved equal)  
 \_\_\_\_\_ volts

**PANEL ARRAY**  
 \_\_\_\_\_ minimum watts needed (pump above 1.25)  
 \_\_\_\_\_ summer tilt angle \_\_\_\_\_ amps  
 \_\_\_\_\_ winter tilt angle \_\_\_\_\_ volts

**PANEL CONFIGURATION<sup>2</sup>**  
 \_\_\_\_\_ series \_\_\_\_\_ parallel

**TANK VOLUME**  
 \_\_\_\_\_ gallons \_\_\_\_\_ no

**FLIGHT SWITCH**  
 \_\_\_\_\_ yes \_\_\_\_\_ no

**WATER TROUGH**  
 \_\_\_\_\_ # of troughs \_\_\_\_\_

**FLIGHT**  
 \_\_\_\_\_ #1 \_\_\_\_\_ #2 \_\_\_\_\_ #3  
 \_\_\_\_\_ min. pressure head to open valves

**FISH SCREEN REQUIRED<sup>3</sup> (at intake)**  
 \_\_\_\_\_ yes \_\_\_\_\_ no

<sup>1</sup> Pump controller, valves, switch box to be specified by manufacturer's recommendation.  
<sup>2</sup> Contractor to provide landowner/NRCS as-built to include panel array configuration and wiring details.  
<sup>3</sup> See Oregon Department of Fish and Wildlife Screening Criteria.

**SOLAR POWERED SUBMERSIBLE PUMP FOR WELL**

**MOUNTING POST DETAIL**

Notes: Care should be taken that all connections associated with the solar power system are made of similar materials to avoid the potential for corrosion.

**MOUNTING POST SELECTION TABLE**  
(Producer shall initial mounting configuration circled below)

POST HEIGHT (FT)	PANELS	MIN. POST DIA. (IN)	POST DIA. (IN)	MIN. EMBEDMENT DEPTH (IN)	MIN. CONCRETE VOLUME (CY)
4 FT	Single Panel (A = 13.9 ft <sup>2</sup> )	4	24	38	0.34
	Double Panel (A = 27.8 ft <sup>2</sup> )	4	24	48	0.71
	Triple Panel (A = 41.7 ft <sup>2</sup> )	4	30	54	1.16
6 FT	Quad Panel (A = 55.6 ft <sup>2</sup> )	4	36	56	1.71
	Single Panel (A = 13.9 ft <sup>2</sup> )	4	24	36	0.38
	Double Panel (A = 27.8 ft <sup>2</sup> )	4	30	50	0.82
8 FT	Triple Panel (A = 41.7 ft <sup>2</sup> )	4	36	54	1.29
	Quad Panel (A = 55.6 ft <sup>2</sup> )	6	36	60	1.82
	Single Panel (A = 13.9 ft <sup>2</sup> )	4	30	38	0.43
10 FT	Double Panel (A = 27.8 ft <sup>2</sup> )	4	30	50	1.16
	Triple Panel (A = 41.7 ft <sup>2</sup> )	6	36	54	1.44
	Quad Panel (A = 55.6 ft <sup>2</sup> )	6	36	60	2.16
10 FT	Single Panel (A = 13.9 ft <sup>2</sup> )	4	24	44	0.45
	Double Panel (A = 27.8 ft <sup>2</sup> )	6	30	52	1.23
	Triple Panel (A = 41.7 ft <sup>2</sup> )	6	36	58	1.57
	Quad Panel (A = 55.6 ft <sup>2</sup> )	8	36	64	2.76

NOTE: Minimum post diameter, post hole diameter, and post depth values have been determined based on the manufacturer's specifications and the local access fibers values will need to be examined by a qualified engineer.

**TANK AND FOUNDATION DETAIL**

**TANK AND FOUNDATION DETAIL**

COMPACTED FILL:  
 cubic yardage =  $[\frac{\pi}{4} (D + 2T) (0.5 \text{ gravel})] \frac{1}{27}$  = \_\_\_\_\_ cu yd

**PV SYSTEM INFORMATION**

**PUMP<sup>1</sup>**  
 \_\_\_\_\_ watts \_\_\_\_\_ design spin  
 \_\_\_\_\_ amps \_\_\_\_\_ manufacturer (or approved equal)  
 \_\_\_\_\_ volts

**PANEL ARRAY**  
 \_\_\_\_\_ minimum watts needed (pump above 1.25)  
 \_\_\_\_\_ summer tilt angle \_\_\_\_\_ amps  
 \_\_\_\_\_ winter tilt angle \_\_\_\_\_ volts

**PANEL CONFIGURATION<sup>2</sup>**  
 \_\_\_\_\_ series \_\_\_\_\_ parallel

**TANK VOLUME**  
 \_\_\_\_\_ gallons \_\_\_\_\_ no

**FLIGHT SWITCH**  
 \_\_\_\_\_ yes \_\_\_\_\_ no

**WATER TROUGH**  
 \_\_\_\_\_ # of troughs \_\_\_\_\_

**FLIGHT**  
 \_\_\_\_\_ #1 \_\_\_\_\_ #2 \_\_\_\_\_ #3  
 \_\_\_\_\_ min. pressure head to open valves

**FISH SCREEN REQUIRED<sup>3</sup> (at intake)**  
 \_\_\_\_\_ yes \_\_\_\_\_ no

<sup>1</sup> Pump controller, valves, switch box to be specified by manufacturer's recommendation.  
<sup>2</sup> Contractor to provide landowner/NRCS as-built to include panel array configuration and wiring details.  
<sup>3</sup> See Oregon Department of Fish and Wildlife Screening Criteria.

**SOLAR POWERED SUBMERSIBLE PUMP FOR WELL**

**SOLAR POWERED SUBMERSIBLE PUMP FOR WELL**

**MOUNTING POST SELECTION TABLE**  
(Producer shall initial mounting configuration circled below)

POST HEIGHT (FT)	PANELS	MIN. POST DIA. (IN)	POST DIA. (IN)	MIN. EMBEDMENT DEPTH (IN)	MIN. CONCRETE VOLUME (CY)
4 FT	Single Panel (A = 13.9 ft <sup>2</sup> )	4	24	38	0.34
	Double Panel (A = 27.8 ft <sup>2</sup> )	4	24	48	0.71
	Triple Panel (A = 41.7 ft <sup>2</sup> )	4	30	54	1.16
6 FT	Quad Panel (A = 55.6 ft <sup>2</sup> )	4	36	56	1.71
	Single Panel (A = 13.9 ft <sup>2</sup> )	4	24	36	0.38
	Double Panel (A = 27.8 ft <sup>2</sup> )	4	30	50	0.82
8 FT	Triple Panel (A = 41.7 ft <sup>2</sup> )	4	36	54	1.29
	Quad Panel (A = 55.6 ft <sup>2</sup> )	6	36	60	1.82
	Single Panel (A = 13.9 ft <sup>2</sup> )	4	30	38	0.43
10 FT	Double Panel (A = 27.8 ft <sup>2</sup> )	4	30	50	1.16
	Triple Panel (A = 41.7 ft <sup>2</sup> )	6	36	54	1.44
	Quad Panel (A = 55.6 ft <sup>2</sup> )	6	36	60	2.16
10 FT	Single Panel (A = 13.9 ft <sup>2</sup> )	4	24	44	0.45
	Double Panel (A = 27.8 ft <sup>2</sup> )	6	30	52	1.23
	Triple Panel (A = 41.7 ft <sup>2</sup> )	6	36	58	1.57
	Quad Panel (A = 55.6 ft <sup>2</sup> )	8	36	64	2.76

NOTE: Minimum post diameter, post hole diameter, and post depth values have been determined based on the manufacturer's specifications and the local access fibers values will need to be examined by a qualified engineer.

### WATER QUALITY AT SOURCE

Very Good Water contains no abrasive particles, and/or TDS < 50 ppm  
 Good Water may contain small amounts of silt, sand, or rust, and/or TDS < 100 ppm  
 Fair Water may contain small amounts of silt, sand, or rust, and/or TDS < 200 ppm  
 Poor Water may contain moderate amounts of silt, sand, or rust, and/or TDS = 200-500 ppm  
 Very Poor Water regularly contains silt, sand, or rust, and/or TDS > 500

COMMENTS: \_\_\_\_\_

### WATER STORAGE DATA

Volume Required = Maximum Daily Requirement (gal/day) x \_\_\_\_\_ days = \_\_\_\_\_ gallons.

Volume Available (gallons):  
 Open Tank \_\_\_\_\_ Press. Tank \_\_\_\_\_ In Line \_\_\_\_\_ Other \_\_\_\_\_ Total \_\_\_\_\_  
 New or Existing: \_\_\_\_\_

### WATER PUMPING DATA

Static Water Depth: \_\_\_\_\_ ft. (Distance from ground to water surface when not pumping).  
 Drawdown Level: \_\_\_\_\_ ft. at \_\_\_\_\_ GPM. (Depth water drops when pumping).  
 Discharge Head: \_\_\_\_\_ ft. (Dist. from ground surface to highest water surface in discharge line)  
 (Use either Discharge Level or Pressure Head, but not both)

Pressure Head: \_\_\_\_\_ ft. (Tank pressure in psi. x 2.31)  
 Losses: \_\_\_\_\_ ft. (Minor and friction losses in discharge line from pump to tank)  
 Total Dynamic Head: \_\_\_\_\_ ft. (Sum of values above).

### WATER SOLAR POWER DATA

Solar Station \_\_\_\_\_ Latitude \_\_\_\_\_

Average kWh/m <sup>2</sup> /day or full sun hours	JAN	FEB	MARCH	APRIL	MAY	JUNE	JULY	AUG	SEPT	OCT	NOV	DEC
Month												
Hours												

Design Solar Radiation Hours = \_\_\_\_\_ hours  
 Design Flow Rate (gpm) = \_\_\_\_\_ gpm (Volume Required) / \_\_\_\_\_ Solar Radiation Hours (1 hour/60 minutes)

### WATER SOURCE INFORMATION

	SUBSURFACE		SURFACE	
	WELL	SPRING	STREAM	POND
Depth (ft)	Yield (gpm)	Flow Rate (gpm)		
Max. Yield (gpm)	COLLECTION BOX DATA	Seasonal or Perennial		
Casing I.D. (in)	Depth (ft)	Min. Water Elev. (ft)		
Well Test (Y or N)	Volume (gal)	Covered (Y or N)		
Date of Test				

### WATER USE INFORMATION

Type of Use	Seasonal Water Requirement (gal/day)		Comments (if or type of animals, type of irrigation, etc.)
	Summer	Fall Winter Spring	
Livestock			
Wildlife			
Irrigation			
Domestic/Portable			
Other			
Total Requirement			

### TYPICAL TRENCH DETAIL

The diagram shows a trench with a width of 0 + 2' (min). The trench is filled with bedding and backfill. A 2 1/2" mho. electrical conduit is placed in the center, with a 6" mho. pipe size. The conduit is surrounded by bedding and backfill. The trench is covered with a final native backfill, which is mounded 4" to 6" with topsoil above natural ground. A recommendation is to locate the ribbon electrical conduit 6" above the electrical conduit.

### SOLAR ISOLATION VALUES

Month	JAN	FEB	MARCH	APRIL	MAY	JUNE	JULY	AUG	SEPT	OCT	NOV	DEC
Hours												

SOLAR POWERED WATERING SYSTEM  
GENERAL INFORMATION

Sheet 2 of 2

Drawing No. \_\_\_\_\_  
 Author: \_\_\_\_\_  
 File Name: \_\_\_\_\_

Natural Resources Conservation Service  
 United States Department of Agriculture  
**NRCS**

CS-8  
 Date: \_\_\_\_\_  
 Drawn: \_\_\_\_\_  
 Checked: \_\_\_\_\_  
 Approved: \_\_\_\_\_  
 Title: \_\_\_\_\_

**SOLAR POWERED ABOVE GROUND PUMP FOR SURFACE WATER COLLECTION**

**PV SYSTEM INFORMATION**

**FUMP<sup>1</sup>**

watts \_\_\_\_\_ design gem \_\_\_\_\_ manufacturer (or approval equal) \_\_\_\_\_  
amps \_\_\_\_\_  
volts \_\_\_\_\_

**PANEL ARRAY** \_\_\_\_\_ minimum watts needed (pump size\*1.25) \_\_\_\_\_ amps \_\_\_\_\_  
summer tilt angle \_\_\_\_\_  
winter tilt angle \_\_\_\_\_  
orientation \_\_\_\_\_

**PANEL CONFIGURATION<sup>2</sup>** \_\_\_\_\_ series \_\_\_\_\_ parallel \_\_\_\_\_

**TANK VOLUME** \_\_\_\_\_ gallons \_\_\_\_\_  
**FLOAT SWITCH** \_\_\_\_\_ yes \_\_\_\_\_ no \_\_\_\_\_

**WATER TROUGHS** \_\_\_\_\_ # of troughs \_\_\_\_\_  
\_\_\_\_\_ size of trough \_\_\_\_\_

**FLOAT** \_\_\_\_\_ #1 \_\_\_\_\_ #2 \_\_\_\_\_  
\_\_\_\_\_ #3 \_\_\_\_\_  
\_\_\_\_\_ min. pressure head to open valves \_\_\_\_\_

**FISH SCREEN REQUIRED<sup>3</sup>** (at intake) \_\_\_\_\_ yes \_\_\_\_\_ no \_\_\_\_\_

<sup>1</sup> Pump controller, valves, switch box to be specified by manufacturer's recommendation  
<sup>2</sup> Contractor to provide inverter/NRCS as-built to include panel array configuration and wiring details  
<sup>3</sup> See Oregon Department of Fish and Wildlife Screening Criteria

**SOLAR POWERED ABOVE GROUND PUMP FOR SURFACE WATER COLLECTION**

**MOUNTING POST DETAIL**

Notes: Care should be taken that all connections associated with the water power system are made of similar materials to avoid the potential for corrosion.

**TANK AND FOUNDATION DETAIL**

**COMPACTED FILL:**  
cubic yardage =  $[\frac{1}{4}(D + 2')] \frac{L}{2} = \text{cu yd}$

6" of well compacted 3/4" minus bedding pad  
woven geotextile fabric  
12" min.

**MOUNTING POST SELECTION TABLE**  
(Producer shall install mounting configuration circled below)

POST HEIGHT (FT)	PANELS	MIN. POST DIA. (IN)	POST HOLE DIA. (IN)	MIN. EMBEDMENT DEPTH (IN)	CONCRETE VOLUME (CY)
4 FT	Single Panel (A = 13.9 ft <sup>2</sup> )	4	24	38	0.34
	Double Panel (A = 27.8 ft <sup>2</sup> )	4	24	48	0.71
	Triple Panel (A = 41.7 ft <sup>2</sup> )	4	30	54	1.16
6 FT	Quad Panel (A = 55.6 ft <sup>2</sup> )	4	36	56	1.71
	Single Panel (A = 13.9 ft <sup>2</sup> )	4	24	36	0.38
	Double Panel (A = 27.8 ft <sup>2</sup> )	4	30	50	0.82
8 FT	Triple Panel (A = 41.7 ft <sup>2</sup> )	4	36	54	1.29
	Quad Panel (A = 55.6 ft <sup>2</sup> )	6	36	60	1.82
	Single Panel (A = 13.9 ft <sup>2</sup> )	4	30	38	0.43
10 FT	Double Panel (A = 27.8 ft <sup>2</sup> )	4	30	50	1.16
	Triple Panel (A = 41.7 ft <sup>2</sup> )	6	36	54	1.44
	Quad Panel (A = 55.6 ft <sup>2</sup> )	6	36	60	2.16
12 FT	Single Panel (A = 13.9 ft <sup>2</sup> )	4	24	44	0.45
	Double Panel (A = 27.8 ft <sup>2</sup> )	6	30	52	1.23
	Triple Panel (A = 41.7 ft <sup>2</sup> )	6	36	58	1.57
14 FT	Quad Panel (A = 55.6 ft <sup>2</sup> )	8	36	64	2.76

NOTE: Minimum post diameter, post hole diameter, and post depth values have been determined based on a 1/2" diameter, 1/2" thick, 1/2" wide, 1/2" high, 1/2" thick, 1/2" wide, 1/2" high, and face bolts exceed these values will need to be examined by a qualified engineer.

**PV SYSTEM INFORMATION**

**FUMP<sup>1</sup>**

watts \_\_\_\_\_ design gem \_\_\_\_\_ manufacturer (or approval equal) \_\_\_\_\_  
amps \_\_\_\_\_  
volts \_\_\_\_\_

**PANEL ARRAY** \_\_\_\_\_ minimum watts needed (pump size\*1.25) \_\_\_\_\_ amps \_\_\_\_\_  
summer tilt angle \_\_\_\_\_  
winter tilt angle \_\_\_\_\_  
orientation \_\_\_\_\_

**PANEL CONFIGURATION<sup>2</sup>** \_\_\_\_\_ series \_\_\_\_\_ parallel \_\_\_\_\_

**TANK VOLUME** \_\_\_\_\_ gallons \_\_\_\_\_  
**FLOAT SWITCH** \_\_\_\_\_ yes \_\_\_\_\_ no \_\_\_\_\_

**WATER TROUGHS** \_\_\_\_\_ # of troughs \_\_\_\_\_  
\_\_\_\_\_ size of trough \_\_\_\_\_

**FLOAT** \_\_\_\_\_ #1 \_\_\_\_\_ #2 \_\_\_\_\_  
\_\_\_\_\_ #3 \_\_\_\_\_  
\_\_\_\_\_ min. pressure head to open valves \_\_\_\_\_

**FISH SCREEN REQUIRED<sup>3</sup>** (at intake) \_\_\_\_\_ yes \_\_\_\_\_ no \_\_\_\_\_

<sup>1</sup> Pump controller, valves, switch box to be specified by manufacturer's recommendation  
<sup>2</sup> Contractor to provide inverter/NRCS as-built to include panel array configuration and wiring details  
<sup>3</sup> See Oregon Department of Fish and Wildlife Screening Criteria

**TANK AND FOUNDATION DETAIL**

**COMPACTED FILL:**  
cubic yardage =  $[\frac{1}{4}(D + 2')] \frac{L}{2} = \text{cu yd}$

6" of well compacted 3/4" minus bedding pad  
woven geotextile fabric  
12" min.

**MOUNTING POST SELECTION TABLE**  
(Producer shall install mounting configuration circled below)

POST HEIGHT (FT)	PANELS	MIN. POST DIA. (IN)	POST HOLE DIA. (IN)	MIN. EMBEDMENT DEPTH (IN)	CONCRETE VOLUME (CY)
4 FT	Single Panel (A = 13.9 ft <sup>2</sup> )	4	24	38	0.34
	Double Panel (A = 27.8 ft <sup>2</sup> )	4	24	48	0.71
	Triple Panel (A = 41.7 ft <sup>2</sup> )	4	30	54	1.16
6 FT	Quad Panel (A = 55.6 ft <sup>2</sup> )	4	36	56	1.71
	Single Panel (A = 13.9 ft <sup>2</sup> )	4	24	36	0.38
	Double Panel (A = 27.8 ft <sup>2</sup> )	4	30	50	0.82
8 FT	Triple Panel (A = 41.7 ft <sup>2</sup> )	4	36	54	1.29
	Quad Panel (A = 55.6 ft <sup>2</sup> )	6	36	60	1.82
	Single Panel (A = 13.9 ft <sup>2</sup> )	4	30	38	0.43
10 FT	Double Panel (A = 27.8 ft <sup>2</sup> )	4	30	50	1.16
	Triple Panel (A = 41.7 ft <sup>2</sup> )	6	36	54	1.44
	Quad Panel (A = 55.6 ft <sup>2</sup> )	6	36	60	2.16
12 FT	Single Panel (A = 13.9 ft <sup>2</sup> )	4	24	44	0.45
	Double Panel (A = 27.8 ft <sup>2</sup> )	6	30	52	1.23
	Triple Panel (A = 41.7 ft <sup>2</sup> )	6	36	58	1.57
14 FT	Quad Panel (A = 55.6 ft <sup>2</sup> )	8	36	64	2.76

NOTE: Minimum post diameter, post hole diameter, and post depth values have been determined based on a 1/2" diameter, 1/2" thick, 1/2" wide, 1/2" high, 1/2" thick, 1/2" wide, 1/2" high, and face bolts exceed these values will need to be examined by a qualified engineer.

**MOUNTING POST DETAIL**

Notes: Care should be taken that all connections associated with the water power system are made of similar materials to avoid the potential for corrosion.

### WATER QUALITY AT SOURCE

Very Good Water contains no abrasive particles, and/or TDS < 50 ppm  
 Good Water may contain small amounts of silt, sand, or rust, and/or TDS < 100 ppm  
 Fair Water may contain small amounts of silt, sand, or rust, and/or TDS < 200 ppm  
 Poor Water may contain moderate amounts of silt, sand, or rust, and/or TDS = 200-500 ppm  
 Very Poor Water regularly contains silt, sand, or rust, and/or TDS > 500

COMMENTS: \_\_\_\_\_

### WATER STORAGE DATA

Volume Required = Maximum Daily Requirement (gal/day) x \_\_\_\_\_ days = \_\_\_\_\_ gallons.

Volume Available (gallons):  
 Open Tank \_\_\_\_\_ Press. Tank \_\_\_\_\_ In Line \_\_\_\_\_ Other \_\_\_\_\_ Total \_\_\_\_\_  
 New or Existing: \_\_\_\_\_

### WATER PUMPING DATA

Static Water Depth: \_\_\_\_\_ ft. (Distance from ground to water surface when not pumping).  
 Drawdown Level: \_\_\_\_\_ ft. at \_\_\_\_\_ GPM. (Depth water drops when pumping).  
 Discharge Head: \_\_\_\_\_ ft. (Dist. from ground surface to highest water surface in discharge line)  
 (Use either Discharge Level or Pressure Head, but not both)

Pressure Head: \_\_\_\_\_ ft. (Tank pressure in psi. x 2.31)  
 Losses: \_\_\_\_\_ ft. (Minor and friction losses in discharge line from pump to tank)  
 Total Dynamic Head: \_\_\_\_\_ ft. (Sum of values above).

### WATER SOLAR POWER DATA

Solar Station \_\_\_\_\_ Latitude \_\_\_\_\_

Average kWh/m<sup>2</sup>/day or full sun hours

JAN	FEB	MARCH	APRIL	MAY	JUNE	JULY	AUG	SEPT	OCT	NOV	DEC
Month											

Design Solar Radiation Hours = \_\_\_\_\_ hours  
 Design Flow Rate (gpm) = \_\_\_\_\_ gpm (Volume Required) / \_\_\_\_\_ Solar Radiation Hours (1 hour/60 minutes)

### SOLAR ISOLATION VALUES

**TYPICAL TRENCH DETAIL**

### WATER SOURCE INFORMATION

	SUBSURFACE		SURFACE	
	WELL	SPRING	STREAM	POND
Depth (ft)	Yield (gpm)	Flow Rate (gpm)		
Max. Yield (gpm)	COLLECTION BOX DATA	Seasonal or Permanent		
Casing I.D. (in)	Depth (ft)	Min. Water Elev. (ft)		
Well Test (Y or N)	Volume (gal)			
Date of Test	Covered (Y or N)			

### WATER USE INFORMATION

Type of Use	Seasonal Water Requirement (gal/day)		Comments (if or type of animals, type of irrigation, etc.)
	Summer	Fall Winter Spring	
Livestock			
Wildlife			
Irrigation			
Domestic/Portable			
Other			
Total Requirement			

### SOLAR GENERAL INFORMATION

United States Department of Agriculture  
 Natural Resources Conservation Service  
**NRCS**

File Name: \_\_\_\_\_  
 User: \_\_\_\_\_  
 Drawing No.: \_\_\_\_\_

Sheet 2 of 2

E:\BLL\Archived\Store\Office\water power TECH NOTE\water\hndld.dwg, 1/22/2011 2:08:15 PM

**SOLAR POWERED SUBMERSIBLE PUMP FOR SURFACE WATER COLLECTION**

**PV SYSTEM INFORMATION**

<sup>1</sup> Pump controller, valves, switch box to be specified by manufacturer's recommendation

<sup>2</sup> Contractor to provide bid/owner/NRCS as-built to include panel array configuration and wiring details

<sup>3</sup> See Oregon Department of Fish and Wildlife Screening Criteria

\_\_\_\_\_ watts \_\_\_\_\_ design gear \_\_\_\_\_ manufacturer (or approved equal)

\_\_\_\_\_ amps \_\_\_\_\_

\_\_\_\_\_ volts \_\_\_\_\_

\_\_\_\_\_ minimum watts needed (pump size=1.25) \_\_\_\_\_

\_\_\_\_\_ summer tilt angle \_\_\_\_\_ amps \_\_\_\_\_

\_\_\_\_\_ winter tilt angle \_\_\_\_\_ volts \_\_\_\_\_

\_\_\_\_\_ parallel \_\_\_\_\_

\_\_\_\_\_ series \_\_\_\_\_

TANK VOLUME \_\_\_\_\_ gallons \_\_\_\_\_

\_\_\_\_\_ yes \_\_\_\_\_ no

WATER TROUGHS \_\_\_\_\_ # of troughs \_\_\_\_\_

\_\_\_\_\_ size of trough \_\_\_\_\_

FLOAT \_\_\_\_\_ #1 \_\_\_\_\_ #2 \_\_\_\_\_ #3 \_\_\_\_\_

\_\_\_\_\_ inch diameter head to open valves \_\_\_\_\_

FISH SCREEN REQUIRED<sup>3</sup> (at intake) \_\_\_\_\_ yes \_\_\_\_\_ no

**MOUNTING POST DETAIL**

\_\_\_\_\_ post height

\_\_\_\_\_ post depth

\_\_\_\_\_ post #

\_\_\_\_\_ mounting post shall be Schedule 40 ASTM 53 steel. Posts shall be hot-dipped galvanized.

\_\_\_\_\_ backfill with concrete

\_\_\_\_\_ Note: Care should be taken that all connections associated with the solar power system are made of similar materials to avoid the potential for corrosion.

**TANK AND FOUNDATION DETAIL**

\_\_\_\_\_ ft

\_\_\_\_\_ in #

\_\_\_\_\_ woven geotextile fabric

\_\_\_\_\_ 6" of well compacted 3/4" minus bedding pad

\_\_\_\_\_ 12" min.

\_\_\_\_\_ COMPACTED FILL: cubic yardage =  $[ \frac{1}{4} (D + 2)^2 (0.5 \text{ gravel}) ] ZT = \text{_____ cu yd}$

\_\_\_\_\_ DETAILS ARE NOT TO SCALE

**MOUNTING POST SELECTION TABLE**  
(Producer shall install mounting configuration circled below)

POST HEIGHT (FT)	PANELS	MIN. POST DIA. (IN)	POST HOLE DIA. (IN)	MIN. EMBEDMENT DEPTH (IN)	CONCRETE VOLUME (CY)
4 FT	Single Panel (A = 13.9 ft <sup>2</sup> )	4	24	38	0.34
	Double Panel (A = 27.8 ft <sup>2</sup> )	4	24	48	0.71
	Triple Panel (A = 41.7 ft <sup>2</sup> )	4	30	54	1.16
6 FT	Quad Panel (A = 55.6 ft <sup>2</sup> )	4	36	56	1.71
	Single Panel (A = 13.9 ft <sup>2</sup> )	4	24	36	0.38
	Double Panel (A = 27.8 ft <sup>2</sup> )	4	30	50	0.82
8 FT	Triple Panel (A = 41.7 ft <sup>2</sup> )	4	36	54	1.29
	Quad Panel (A = 55.6 ft <sup>2</sup> )	6	36	60	1.82
	Single Panel (A = 13.9 ft <sup>2</sup> )	4	30	38	0.43
10 FT	Double Panel (A = 27.8 ft <sup>2</sup> )	4	30	50	1.16
	Triple Panel (A = 41.7 ft <sup>2</sup> )	6	36	54	1.44
	Quad Panel (A = 55.6 ft <sup>2</sup> )	6	36	60	2.16
12 FT	Single Panel (A = 13.9 ft <sup>2</sup> )	4	24	44	0.45
	Double Panel (A = 27.8 ft <sup>2</sup> )	6	30	52	1.23
	Triple Panel (A = 41.7 ft <sup>2</sup> )	6	36	58	1.57
14 FT	Quad Panel (A = 55.6 ft <sup>2</sup> )	8	36	64	2.76
	Single Panel (A = 13.9 ft <sup>2</sup> )	4	30	44	0.45

NOTE: Minimum post diameter, post hole diameter, and post depth values have been determined based on a 1000 lb. panel. For other panel weights and dimensions, and face loads exceed these values will need to be examined by a qualified engineer.

### WATER SOURCE INFORMATION

SUBSURFACE		SURFACE	
WELL	SPRING	STREAM	POND
Depth (ft)	Yield (gpm)	Flow Rate (gpm)	
Max. Yield (gpm)	COLLECTION BOX DATA	Seasonal or Permanent	
Casing I.D. (in)	Depth (ft)	Min. Water Elev. (ft)	
Well Test (Y or N)	Volume (gal)		
Date of Test	Covered (Y or N)		

Design: \_\_\_\_\_  
Drawn: \_\_\_\_\_  
Checked: \_\_\_\_\_  
Approved: \_\_\_\_\_  
Title: \_\_\_\_\_

### WATER USE INFORMATION

Type of Use	Seasonal Water Requirement (gal/day)		Comments (if or type of animals, type of irrigation, etc.)
	Summer	Fall Winter Spring	
Livestock			
Wildlife			
Irrigation			
Domestic/Portable			
Other			
Total Requirement			

United States Department of Agriculture  
**NRCS**  
Natural Resources Conservation Service

File Name: \_\_\_\_\_  
User: \_\_\_\_\_  
Drawing No.: \_\_\_\_\_

Sheet 2 of 2

### WATER QUALITY AT SOURCE

Very Good: Water contains no abrasive particles, and/or TDS < 50 ppm  
 Good: Water may contain small amounts of silt, sand, or rust, and/or TDS < 100 ppm  
 Fair: Water may contain small amounts of silt, sand, or rust, and/or TDS < 200 ppm  
 Poor: Water may contain moderate amounts of silt, sand, or rust, and/or TDS = 200-500 ppm  
 Very Poor: Water regularly contains silt, sand, or rust, and/or TDS > 500

COMMENTS: \_\_\_\_\_

### WATER STORAGE DATA

Volume Required = Maximum Daily Requirement (gal/day) x \_\_\_\_\_ days = \_\_\_\_\_ gallons.

Volume Available (gallons):  
 Open Tank \_\_\_\_\_ Press. Tank \_\_\_\_\_ In Line \_\_\_\_\_ Other \_\_\_\_\_ Total \_\_\_\_\_  
 New or Existing: \_\_\_\_\_

### WATER PUMPING DATA

Static Water Depth: \_\_\_\_\_ ft. (Distance from ground to water surface when not pumping).  
 Drawdown Level: \_\_\_\_\_ ft. at \_\_\_\_\_ GPM. (Depth water drops when pumping).  
 Discharge Head: \_\_\_\_\_ ft. (Dist. from ground surface to highest water surface in discharge line)  
 (Use either Discharge Level or Pressure Head, but not both)

Pressure Head: \_\_\_\_\_ ft. (Tank pressure in psi. x 2.31)  
 Losses: \_\_\_\_\_ ft. (Minor and friction losses in discharge line from pump to tank)  
 Total Dynamic Head: \_\_\_\_\_ ft. (Sum of values above).

### WATER SOLAR POWER DATA

Solar Station \_\_\_\_\_ Latitude \_\_\_\_\_

Average kWh/m <sup>2</sup> /day or full sun hours	SOLAR ISOLATION VALUES											
	JAN	FEB	MARCH	APRIL	MAY	JUNE	JULY	AUG	SEPT	OCT	NOV	DEC
Month												
Hours												

Design Solar Radiation Hours = \_\_\_\_\_ hours  
 Design Flow Rate (gpm) = \_\_\_\_\_ gpm (Volume Required) / \_\_\_\_\_ Solar Radiation Hours (1 hour/60 minutes)

### TYPICAL TRENCH DETAIL

## APPENDIX G: Friction Head Loss for Schedule 40 PVC Plastic Pipe

Head loss in feet per 100 feet of pipe  
for Schedule 40 PVC Plastic  
C = 150

GPM	Nominal Pipe Diameter											
	½	¾	1	1¼	1½	2	2½	3	4	5	6	
1	1.16	0.28	0.09	0.02	0.01							
2	4.19	1.03	0.31	0.08	0.04	0.01						
3	8.88	2.17	0.65	0.17	0.08	0.02	0.01					
4	15.13	3.70	1.11	0.29	0.13	0.04	0.02	0.01				
5	22.88	5.60	1.69	0.43	0.20	0.06	0.02	0.01				
6	32.07	7.85	2.36	0.61	0.28	0.08	0.04	0.01				
7		10.44	3.14	0.81	0.38	0.11	0.05	0.02				
8		13.37	4.02	1.04	0.48	0.14	0.06	0.02	0.01			
9		16.63	5.01	1.29	0.60	0.18	0.07	0.03	0.01			
10		20.21	6.08	1.57	0.73	0.21	0.09	0.03	0.01			
11			7.26	1.87	0.87	0.26	0.11	0.04	0.01			
12			8.53	2.20	1.03	0.30	0.13	0.04	0.01			
14			11.34	2.92	1.37	0.40	0.17	0.06	0.02	0.01		
16			14.53	3.74	1.75	0.51	0.22	0.07	0.02	0.01		
18				4.65	2.17	0.64	0.27	0.09	0.02	0.01		
20				5.65	2.64	0.77	0.33	0.11	0.03	0.01		
22				6.75	3.15	0.92	0.39	0.13	0.04	0.01		
24				7.92	3.71	1.08	0.46	0.16	0.04	0.01	0.01	
26				9.19	4.30	1.26	0.53	0.18	0.05	0.02	0.01	
28					4.93	1.44	0.61	0.21	0.06	0.02	0.01	
30					5.60	1.64	0.69	0.24	0.06	0.02	0.01	
35	Warning: Velocity exceeds 5 ft/s in shaded cells.				7.45	2.18	0.92	0.32	0.08	0.03	0.01	
40					9.54	2.79	1.18	0.41	0.11	0.04	0.01	
45						3.47	1.46	0.51	0.13	0.04	0.02	
50						4.22	1.78	0.61	0.16	0.05	0.02	
55						5.03	2.12	0.73	0.19	0.06	0.03	
60						5.92	2.49	0.86	0.23	0.08	0.03	
65							2.89	1.00	0.26	0.09	0.04	
70							3.32	1.15	0.30	0.10	0.04	
75							3.77	1.30	0.34	0.11	0.05	
80							4.25	1.47	0.39	0.13	0.05	
85								1.64	0.43	0.14	0.06	
90								1.82	0.48	0.16	0.07	
95								2.02	0.53	0.18	0.07	
100								2.22	0.59	0.19	0.08	
150									1.24	0.41	0.17	
200									2.12	0.70	0.29	

# APPENDIX H: Sample Well Log

**RECEIVED**  
**SAMPLE**  
 DEC 18 2006  
 2N/17E/09CH  
 W-18614

STATE OF OREGON  
**WATER WELL REPORT**  
 (as required by ORS 537.765)

(1) OWNER: Name Joe and Jane Smith Well Number: \_\_\_\_\_  
 Address 1756 Cattle Ln  
 City Mosier State OR Zip 97040

(2) TYPE OF WORK:  
 New Well  Deepen  Recondition  Abandon

(3) DRILL METHOD  
 Rotary Air  Rotary Mud  Cable  
 Other

(4) PROPOSED USE:  
 Domestic  Community  Industrial  Irrigation  
 Thermal  Injection  Other

(5) BORE HOLE CONSTRUCTION: 271  
 Special Construction approval Yes  No  Depth of Completed Well \_\_\_\_\_ ft.  
 Explosives used  Yes  No  Type \_\_\_\_\_ Amount \_\_\_\_\_

HOLE		SEAL		Amount	
Diameter	From To	Material	From To	sacks	pounds
12"	0 18	Bentonite	0 18	25	sacks
10"	18 270				
6"	0 269				

How was seal placed: Method  A  B  C  D  E  
 Other Poured around 6" casing in oversize hole  
 Backfill placed from \_\_\_\_\_ ft. to \_\_\_\_\_ ft. Material \_\_\_\_\_  
 Gravel placed from 20 ft. to 250 ft. Size of gravel 3/4 minus

(6) CASING/LINER:

Diameter	From	To	Gauge	Steel	Plastic	Welded	Threaded
Casing: 6"	+1	269	250	<input checked="" type="checkbox"/>	<input type="checkbox"/>	<input checked="" type="checkbox"/>	<input type="checkbox"/>
Liner:				<input type="checkbox"/>	<input type="checkbox"/>	<input type="checkbox"/>	<input type="checkbox"/>

Final location of shoe(s) 269

(7) PERFORATIONS/SCREENS:  
 Perforations Method cutting torch  
 Screens Type \_\_\_\_\_ Material \_\_\_\_\_

From	To	Slot size	Number	Diameter	Telo/pipe size	Casing	Liner
220	240	1/8" x 6"	76		6"	<input checked="" type="checkbox"/>	<input type="checkbox"/>

(8) WELL TESTS: Minimum testing time is 1 hour  
 Pump  Bailer  Air  Flowing Artesian  
 Yield gal/min 30 Drawdown 9 ft Drill stem at \_\_\_\_\_ Time 4 hr.

Temperature of water 60° Depth Artesian Flow Found \_\_\_\_\_  
 Was a water analysis done?  Yes By whom Water Testing Analytical  
 Did any strata contain water not suitable for intended use?  Yes  No Too little  
 Salty  Muddy  Odor  Colored  Other \_\_\_\_\_  
 Depth of strata: \_\_\_\_\_

(9) LOCATION OF WELL by legal description:  
 County Wasco Latitude \_\_\_\_\_ Longitude \_\_\_\_\_  
 Township 2 N N or S, Range 11 E E or W, WM.  
 Section 11 NE 1/4 SE 1/4  
 Tax Lot 321 Lot \_\_\_\_\_ Block \_\_\_\_\_ Subdivision \_\_\_\_\_  
 Street Address of Well (or nearest address) same

(10) STATIC WATER LEVEL:  
185 ft. below land surface. Date 11-19-06  
 Artesian pressure \_\_\_\_\_ lb. per square inch. Data \_\_\_\_\_

(11) WATER BEARING ZONES:  
 Depth at which water was first found 195

From	To	Estimated Flow Rate	SWL
195	270	40 GPM	185

(12) WELL LOG: Ground elevation approx. 2200

Material	From	To	SWL
overdrilled 6" casing	0	30	
Sandstone, brown rocky	0	30	
Silty brown sandstone	30	130	
Sandstone, brown	130	195	
Sandstone, grey	195	225	185
Sand & gravel	225	265	185
Clay, brown	265	269	185
original well casing		30 ft	
bottom had filled in with loose rocks, etc.			

Date started Oct 17, 2006 Completed Nov 19, 2006

(unbonded) Water Well Constructor Certification:  
 I certify that the work I performed on the construction, alteration, or abandonment of this well is in compliance with Oregon well construction standards. Materials used and information reported above are true to my best knowledge and belief.  
 Signed \_\_\_\_\_ WWC Number \_\_\_\_\_ Date \_\_\_\_\_

(bonded) Water Well Constructor Certification:  
 I accept responsibility for the construction, alteration, or abandonment work performed on this well during the construction dates reported above. All work performed during this time is in compliance with Oregon well construction standards. This report is true to the best of my knowledge and belief.  
 Signed [Signature] WWC Number 426 Date 12-18-06

ORIGINAL & FIRST COPY - WATER RESOURCES DEPARTMENT SECOND COPY - CONSTRUCTOR THIRD COPY - CUSTOMER 8809C 3/88





ditch screens to safely and rapidly collect and transport fish back to the stream.

**Screen approach velocity for *passive* pump screens** shall not exceed 0.2 fps or 0.06 mps. The wetted screen area in square feet is calculated by dividing the maximum water flow rate by 0.2 fps. Pump rate must be less than 3 cfs. \* **Passive pump screens are only allowed where there is insufficient depth in the water body to operate a self-cleaning pump screen.**

- **Pump screens should have internal balance tubes for uniform approach velocity. A pump screen without balance tubes must have more wetted screen surface than indicated in these formulas.**

***For further information please contact:***

Oregon Department of Fish and  
Wildlife, Statewide Fish Screening  
Coordinator: 503.947.6229

Oregon Department of Fish and  
Wildlife, Screening Program  
Administrative Specialist: 503.947.6224

## APPENDIX J: Solar Panel Wiring

PV solar panels can be wired together in series, in parallel or in a combination of series and parallel to obtain the needed output voltage and current. Solar panels have a negative (-) and a positive terminal (+) similar to the terminals on a battery.

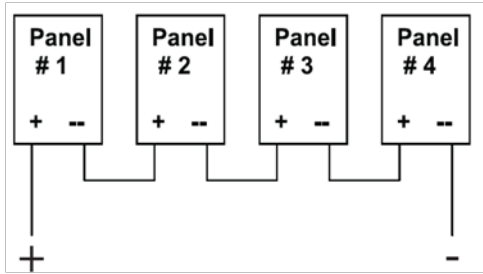

**Figure H 3 - Figure H-1.** Solar panel wiring in series.

**PV panels are wired in series** by connecting the negative terminal of one panel to the positive terminal of the next panel as shown in Figure H-1. When panels are wired in series, the panel voltages are added.

If the panel has the characteristics shown in Table 2, the resultant voltage output for panels shown in Figure A5-1 is

$$35.5 + 35.5 + 35.5 + 35.5 = 142 \text{ V}$$

The current output would be the same as for an individual panel or 3.3 A.

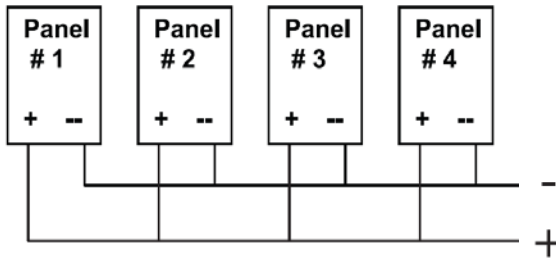

**Figure H 3 -** Solar panel wiring in parallel.

**Panels are wired in parallel** by connecting positive terminals and negative terminals as shown in Figure H-2

In this case, the output voltage is the same as the individual panel voltage, and the currents of individual panels are added.

For the panel characteristics shown in Table 2, the output for panels in parallel is:

$$3.3 + 3.3 + 3.3 + 3.3 = 13.2 \text{ A}$$

The output voltage is 35.5 V

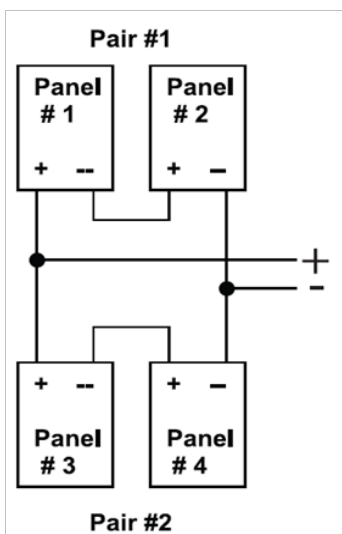

**Figure H 3 - Figure H-3.** Solar panel wiring in combination of series and parallel.

**A series/parallel circuit** as shown in Figure H-3 is considered to be two or more series circuits that are wired together in parallel. In the example, two panels are wired in series, and two of these groups are wired in parallel.

The voltage output for two panels in series (using the information from Table 1) is:

$$35.5 + 35.5 = 71 \text{ V}$$

The current produced is the sum of the current produced by each group of two panels wired in series:

$$3.3 + 3.3 = 6.6 \text{ A}$$

The total power produced by all configurations is:

$$71 \text{ V} \times 6.6 \text{ A} = 468.6 \text{ W}$$

The values for voltage and current must meet the requirements of the motor supplied.

## APPENDIX K: Glossary of Solar-Powered Water Pump Terms

---

<b>Alternating Current (AC)</b>	An electric current that reverses its direction at regularly recurring intervals.
<b>Amperes (Amps or A)</b>	A measure of electric current in a conductor. The voltage drop in a conductor is directly related to the current (A). (See Voltage Drop.)
<b>Booster Pump</b>	A surface pump used to increase pressure in a water line or to pull water from a storage tank and pressurize a water system. (See Surface Pump.)
<b>Cable Splice</b>	A joint in an electrical cable.
<b>Casing</b>	A plastic or steel tube that is permanently inserted into a well after it is drilled. Its size is specified according to its inside diameter.
<b>Centrifugal Pump</b>	A pumping mechanism that spins water by means of an impeller. Water is forced out of the impeller by centrifugal force, thus giving energy (head) to the water. (Also see Multi-Stage Centrifugal Pump.)
<b>Check Valve</b>	A valve that allows water to flow one way but not the other.
<b>DC Motor, Brush-Type</b>	A traditional DC motor in which small, conductive carbon blocks, called "brushes," conduct current into the spinning portion of the motor. They are used in DC surface pumps and also in some DC submersible pumps. Brushes naturally wear with time and must be replaced. (See Direct Current (DC).)
<b>DC Motor, Permanent Magnet</b>	A DC motor that solar pumps use in some form. Being a variable speed motor by nature, reduced input power (in low sun) produces proportionally reduced speed and causes no harm to the motor. (See Direct Current (DC). Contrast with Induction Motor.)
<b>Diaphragm Pump</b>	A type of pump in which water is drawn in and forced out of one or more chambers by a flexible diaphragm. Check valves let water into and out of each chamber. (See Check Valve.)
<b>Direct Current (DC)</b>	An electric current flowing in one direction only and substantially constant in value.
<b>Drawdown</b>	The lowering of the level of water in a well due to pumping.
<b>Drop Pipe</b>	The pipe that carries water from a pump in a well up to the surface.
<b>Flow Rate</b>	The amount of fluid that flows in a given time, normally expressed in units of gallons per minute (gpm) in solar-powered systems.
<b>Foot Valve</b>	A check valve placed in the water source below a surface pump. It prevents water from flowing back down the pipe and causing the pump to lose prime. (See Check Valve and Priming.)
<b>Friction Loss</b>	The loss of pressure due to the friction caused by the flow of water in a pipe. Friction loss is determined by four factors: the pipe size (inside diameter), the flow rate, the length of the pipe, and the pipe's roughness. It is determined by consulting a friction loss chart available in an engineering reference book or a pipe supplier. Friction loss is normally expressed in psi or ft per length of pipe. (See Flow Rate.)

<b>Gravity Flow</b>	The use of gravity to produce pressure and water flow (2.31 vertical feet = 1 psi). A storage tank will be elevated above the point of use so that water will flow with no further pumping required. A booster pump may be used to increase pressure. (See Pressure.)
<b>Head</b>	The amount of energy per unit weight of water. The three principle components of head are the elevation (lift), pressure, and velocity of flowing water. A pump is used to impart head to water. (See Vertical Lift and Total Dynamic Head.)
<b>Impeller</b>	See Centrifugal Pump.
<b>Induction Motor (AC)</b>	The type of electric motor used in conventional AC water pumps. It requires a high surge of current to start and a stable voltage supply, making it relatively expensive to run by solar power. (See Inverter, Alternating Current, and Volt.)
<b>Inverter</b>	An electronic control device that produces AC output from DC input. (See Alternating Current (AC) and Direct Current (DC).)
<b>Kilowatt (kW)</b>	A unit of power equal to 1,000 Watts. (See Watt.)
<b>Kilowatt-Hour (kWh)</b>	A unit of energy that is the multiplication of power in kilowatts (kW) and time in hours. (See Kilowatt (kW).)
<b>Linear Current Booster (LCB)</b>	An electronic device that conditions the voltage and current of a PV array to match the needs of a DC-powered pump, especially a positive displacement pump. It allows the pump to start and run under low sun conditions without stalling. It is also called a pump controller. (See Pump Controller, Volt, and Direct Current (DC).)
<b>Multi-Stage Centrifugal Pump</b>	A centrifugal pump with multiple impellers arranged in series to produce higher pressure (head). (See Centrifugal Pump.)
<b>National Electrical Code (NEC)</b>	A United States standard for the safe installation of electrical wiring and equipment published by the National Fire Protection Association.
<b>Open Discharge</b>	The filling of a water vessel that is not sealed to hold pressure (e.g., a water tank, storage (holding) tank, or pond). Flood irrigation is a form of open discharge. (Contrast with Pressure Tank.)
<b>Perforations</b>	Slits cut into the well casing to allow groundwater to enter. They may be located at more than one level to coincide with water-bearing strata in the earth. (See Casing.)
<b>Photovoltaic (PV) Panel</b>	An array of photovoltaic cells encapsulated in a protective frame and transparent cover and manufactured to meet specific standards. PV panels are normally rated based on their power output, including voltage and amperage. (See Amperes and Volts.)
<b>Pitless Adapter</b>	A below-ground pipe fitting for a well casing that allows the pump discharge pipe to pass horizontally through the casing so that no pipe is exposed above ground, where it could freeze. The adapter contains a seal so the pump can be installed and removed without further need to dig around the casing. (See Casing.)
<b>Positive Displacement Pump</b>	Any mechanism that seals water in a chamber, then forces it out by reducing the volume of the chamber (e.g., a piston (including a jack), diaphragm, or rotary vane). It is used for low volume and high lift. (Contrast with Centrifugal Pump.)
<b>Pounds per Square Inch (psi)</b>	See Pressure.

<b>Pressure</b>	The amount of force produced by water over a given area, normally measured in pounds per square inch (psi). One psi will sustain a vertical column of water 2.31 ft tall (psi X 2.31 = ft of head).
<b>Pressure Switch</b>	An electrical switch actuated by the pressure in a pressure tank. When the pressure drops to a low set point (cut-in), the pressure switch turns the pump on. When the pressure reaches a high point (cut-out), the pressure switch turns the pump off. (See Pressure Tank.)
<b>Pressure Tank</b>	A fully enclosed tank that contains air space. As water is forced in, the air compresses. The stored water may be released after the pump has stopped. Most pressure tanks use a rubber bladder to contain the air and are referred to as “captive air tanks.”
<b>Pressure Tank Precharge</b>	The pressure of compressed air stored in a pressure tank. A reading should be taken with an air pressure gauge (tire gauge) when the water pressure is at zero. The air pressure should then be adjusted to about 3 psi lower than the cut-in pressure. If the precharge is not set properly, the tank will not work at full capacity and the pump will cycle on and off more frequently. (See Pressure Switch and Pressure Tank.)
<b>Priming</b>	The process of hand filling the suction and intake pipes of a surface pump with water. Priming is generally necessary when a pump is located above the water source. (See Foot Valve.)
<b>Pulsation Damper</b>	A device that absorbs and releases pulsations in the water flow produced by a piston or diaphragm pump. It consists of a chamber with entrapped air.
<b>Pump Controller</b>	An electronic device that controls or processes power between the solar array and the pump. It may perform any of the following functions: stopping and starting the pump, protecting the pump from overload, and converting or matching power. (See Linear Current Booster).
<b>Recovery Rate</b>	The rate at which groundwater refills a well casing after the water level is drawn down. This term is used to define the production rate of the well. (See Casing and Drawdown.)
<b>Safety Rope</b>	Plastic rope used to secure the pump in case of pipe breakage.
<b>Sealed Piston Pump</b>	A type of pump recently developed for solar submersibles. The pistons have a very short stroke, allowing the use of flexible gaskets to seal water out of the oil-filled mechanisms. (See Positive Displacement Pump.)
<b>Self-Priming Pump</b>	A pump that is able to draw some air suction in order to prime itself, at least in theory. (See Priming.)
<b>Solar Azimuth Angle</b>	The azimuth angle of the sun relative to due south.
<b>Solar Elevation Angle</b>	The elevation angle of the sun, which is related to latitude and time of year. The greater the latitude, the lower the solar elevation angle. The elevation angle is greatest at summer solstice and least at winter solstice.
<b>Solar Insolation</b>	A measure of the solar radiation energy received on a given surface area in a given time. Values for solar insolation are commonly expressed in watts per square meter ( $W/m^2$ ) or kilowatt-hours per square meter per day ( $kW \cdot h / (m^2 \cdot day)$ ). In the case of photovoltaics, it may be measured as kilowatt-hours per year per kilowatt peak rating ( $kWh / (kW_p \cdot y)$ ). Solar insolation values are dependent on latitude, time of year, and local conditions, such as cloud cover. (See Kilowatts (kW), Kilowatt-Hours (kWh), and Watts (W).)

<b>Static Water Level</b>	The depth to the water surface in a well under static conditions (when it is not being pumped). It may be subject to seasonal changes or change after extended pumping.
<b>Submergence</b>	As applied to submersible pumps, the distance beneath the static water level at which a pump is set. Synonym: immersion level.
<b>Submersible Cable</b>	An electrical cable designed for in-well submersion. The conductor (wire) sizing is specified in millimeters or (in the U.S.) by American Wire Gauge (AWG). (See Wire Gage.)
<b>Submersible Pump</b>	A motor/pump combination designed to be placed entirely below the water surface.
<b>Submersible Splice</b>	A waterproof splice made using special materials typically available in kit form. (See Cable Splice.)
<b>Suction Lift</b>	As applied to surface pumps, the vertical distance from the surface of the water supply to the pump. This distance should be no more than approximately 20 feet at sea level (subtract 1 ft per 1,000 ft altitude) and should be minimized for best results.
<b>Surface Pump</b>	A pump that is not submersible. It must be placed no more than about 20 ft above the surface of the water in the well. (See Priming and Submersible Pump.)
<b>Total Dynamic Head</b>	Vertical lift + pressure head (psi/2.31) + friction loss in piping. It is sometimes referred to as "Pumping Head." (See Vertical Lift, Pressure, and Friction Loss.)
<b>Vane Pump</b>	A positive displacement mechanism used in low volume, high lift surface pumps and booster pumps, also known as a "rotary vane." It is durable and efficient, but should be used only for pumping clean water due to its mechanical precision. (See Booster Pump, Surface Pump, and Vertical Lift.)
<b>Vertical Lift</b>	The vertical distance that water is pumped.
<b>Volts (V)</b>	A measure of electric potential.
<b>Voltage Drop</b>	The drop in voltage within an electrical system due to electrical resistance and losses in the system, including in the wires and controls. The voltage drop in a conductor (wire) is directly related to the current (A), the size of the conductor, and the type of conductor material. An allowable voltage drop may be specified by the manufacturer and/or the National Electrical Code. (See Amperes (A) and National Electric Code (NEC).)
<b>Watts (W)</b>	A measure of electric power. Watts = Volts x Amps. 1 W = 1 V X 1 A 1,000 W = 1 kW 1 kW = 1.34 horsepower 1 horsepower = 746 W = 0.746 kW
<b>Wellhead</b>	The top of the well near ground level.
<b>Well Seal</b>	The top plate of a well casing that provides a sanitary seal and support for the drop pipe and pump. (Alternative: See Pitless Adapter).
<b>Wire Gage</b>	The diameter of wire, including electrical wire. In the American Wire Gage (AWG) system, the wire size decreases with an increasing AWG number. In the metric wire gage scale, the wire size increases with an increasing metric wire gage.