

# A Collection of Contemporary Toilet Designs



E00S and WEDC



# **A Collection of Contemporary Toilet Designs**

EOOS and WEDC

In 2011, the Water, Sanitation & Hygiene program at the Bill & Melinda Gates Foundation initiated the Reinvent the Toilet Challenge to bring sustainable sanitation solutions to the 2.5 billion people worldwide who don't have access to safe, affordable sanitation.

Grants have since been awarded to researchers and industries around the world who are using innovative approaches – based on fundamental engineering processes – for the safe and sustainable management of human waste. The Reinvent the Toilet Challenge aims to create a toilet that:

- Removes germs from human waste and recovers valuable resources such as energy, clean water, and nutrients.
- Operates 'off the grid' without connections to water, sewer, or electrical lines.
- Costs less than US\$.05 cents per user per day.
- Promotes sustainable and financially profitable sanitation services and businesses that operate in poor, urban settings.
- Is a truly aspirational next-generation product that everyone will want to use – in developed as well as developing nations.

Innovative solutions change people's lives for the better. By applying creative thinking to everyday challenges, such as dealing with human waste, we can fix some of the world's toughest problems. We hope the designs displayed in this book will encourage further research and investments in improved sanitation.

Doulaye Kone, PhD  
Senior Program Officer, WSH, Toilet Team  
Transformatives Technologies  
Global Development

---

Book edited and designed by Rod Shaw  
Illustrations by Ken Chatterton

Published by WEDC, Loughborough University, 2014

An online copy of this publication is available from:  
<http://wedc.lboro.ac.uk/knowledge/>

Hypertext links to further information listed in this volume were active as of 18 January 2014.

ISBN: 978 1 84380 155 9

All reasonable precautions have been taken by the WEDC, Loughborough University to verify the information contained in this publication. However, WEDC, Loughborough University does not necessarily endorse the technologies presented in this document. The published material is being distributed without warranty of any kind, either expressed or implied. The responsibility for the interpretation and use of the material lies with the reader. In no event shall the WEDC, Loughborough University be liable for damages as a result of their use.

# Preface

In August 2012, I met the EOOS representative in Seattle through Dr Carl Hensman of the Bill & Melinda Gates Foundation where we started to think about ways to present a collection of contemporary toilet designs that would spark a wider interest in the subject.

Alongside the Reinvent the Toilet Challenge of the Foundation, EOOS (based in Austria) had started to collect information relating to the design of its Blue Diversion Toilet as well as other toilet designs. The information was initially gathered together in a research log, which, although not a project with an encyclopaedic scientific focus, provided insight into new and innovative ways of addressing global sanitation issues.

This collection is the result of the findings of EOOS research which was supported by Sandec, the Department of Water and Sanitation in Developing Countries at the Swiss Federal Institute of Aquatic Science and Technology (Eawag). It covers a wide range of contemporary designs along with a valuable list of website links where additional information about each design can be sought.

The research log was an interesting tool for the transfer of knowledge internally. Externally, designers, manufacturers, social researchers and others, including the Gates Foundation, appreciated the work as it served as a point of departure for toilet design projects for those new to the field.

This volume is a synthesis of the initial research log, designed and produced by The Water Engineering and Development Centre (WEDC) at Loughborough University. As conventional toilet designs are not included, it does not claim to be fully comprehensive but it nevertheless provides a useful overview of current research and development for fieldworkers and practitioners as well as engineers and researchers.

As a member of WEDC, Loughborough University, and a lead on one of the RTTC grants, I am pleased that this document is now available for a wider audience. But this is only a start: we intend to keep adding new innovations to our collection. So if there are any innovations we have missed please let us know. I sincerely hope that this endeavour will help to make the toilet a more desirable product, one that people will cherish in their homes.

Professor M.Sohail Khan  
BEng, MSc, PhD Loughborough, Fellow ASCE (USA)  
Professor of Sustainable Infrastructure  
Water, Engineering and Development Centre (WEDC)  
School of Civil and Building Engineering  
Loughborough University

A number of the designs are the result of student projects and these are marked with an asterisk (\*).



# Contents

<b>Contemporary Toilet Designs</b> .....	<b>1</b>
2P Portable Restroom* .....	2
Aquatron Toilet.....	3
Blue Diversion Toilet .....	4
Bipee* .....	5
Built-in Composting System .....	6
Camping Toilets .....	7
Caravan Toilets .....	8
Cinderella Toilet .....	9
Drysan Waterless Toilet.....	10
EkoToi .....	11
Envirosan.....	12
Eram Delight .....	13
Fresh Life Toilet .....	14
Ghanasan .....	15
Green, Portable Eco-toilet* .....	16
Hightech Composting Toilet: Ecodomeo .....	17
IDE EZ Latrine.....	18
Indoor Self-contained Toilet .....	19
Intestinal Toilet.....	20
Locus Toilet.....	21
Loowatt Toilet.....	22
MoSan – Mobile Sanitation .....	23
Open Privy* .....	24
Otji Toilet.....	25
PeePoo .....	26
Piet Urine Diversion Toilet* .....	27
Public Rest Room .....	28
Resource Toilet .....	29
Rolling Toilet: x-runner .....	30
SimSan .....	31
Waterless Toilet* .....	32
WC der Zukunft.....	33
WooWoo .....	34

<b>Controlling Odour .....</b>	<b>35</b>
Controlling odour from urine .....	36
Rubber tube seal .....	36
Condoms – The low-tech alternative .....	36
Valve seals.....	36
Sealant liquid.....	37
Light bulb / table tennis ball .....	37
Controlling odour from faeces .....	38
Ventilation.....	38
Soil, ash, sawdust, sand or lime.....	38



# **Contemporary Toilet Designs**

# 2P Portable Restroom\*

The 2P is a portable restroom designed to counter the problems that arise due to heavy attendance at outdoor events. Through innovative placement of an external urinal, it promotes dual-functionality per unit which effectively cuts all lines in half, improves hygienic conditions and reduces cost, space, and it's carbon footprint.

External urinal cut into the back corner of the unit and when stacked as shown the adjacent unit provides privacy for users.

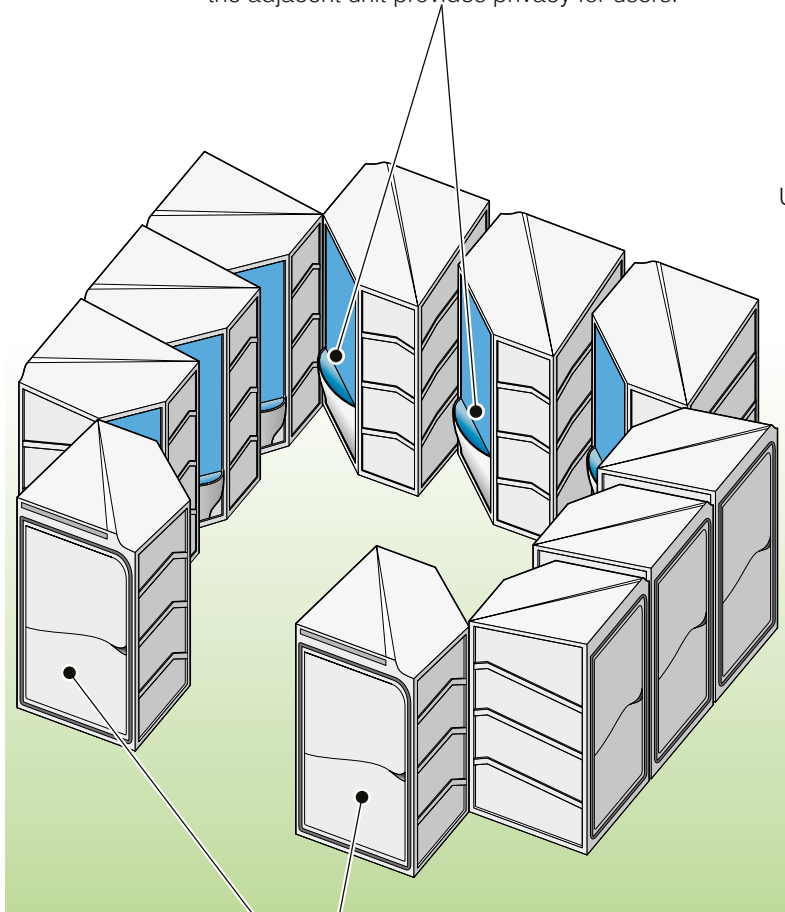

Entrance to toilet and wash facilities which share the same waste tank as the urinal

Exterior urinal

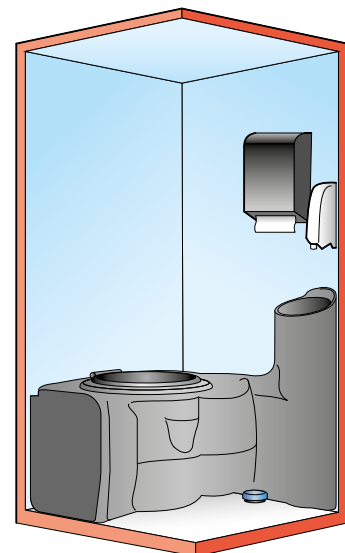
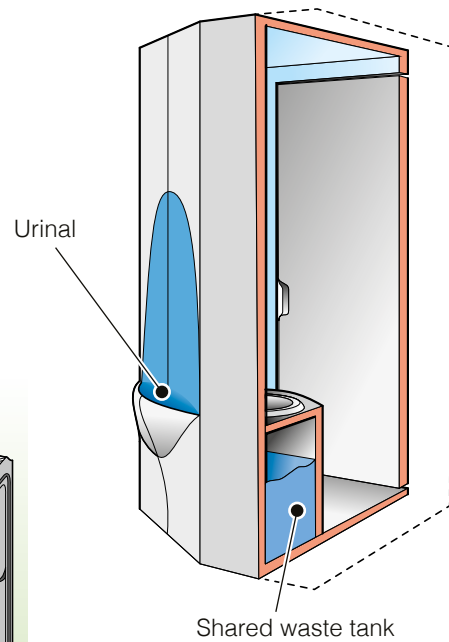

Interior toilet and wash facilities

## Links

<http://www.core77designawards.com/2011/recipients/2p-portable-restroom/>

<http://www.core77designawards.com/wp-content/uploads/2011/07/Products-Student-e588-d.pdf>

# Aquatron Toilet

A composting water saving toilet system separating solids from fluids for composting and wastewater treatment. The Aquatron can flush 3 litres at a time. The separation of liquids from effluent significantly improves efficiency and the unit can operate up to 20 metres from the toilet making it easy to use and relatively inexpensive.

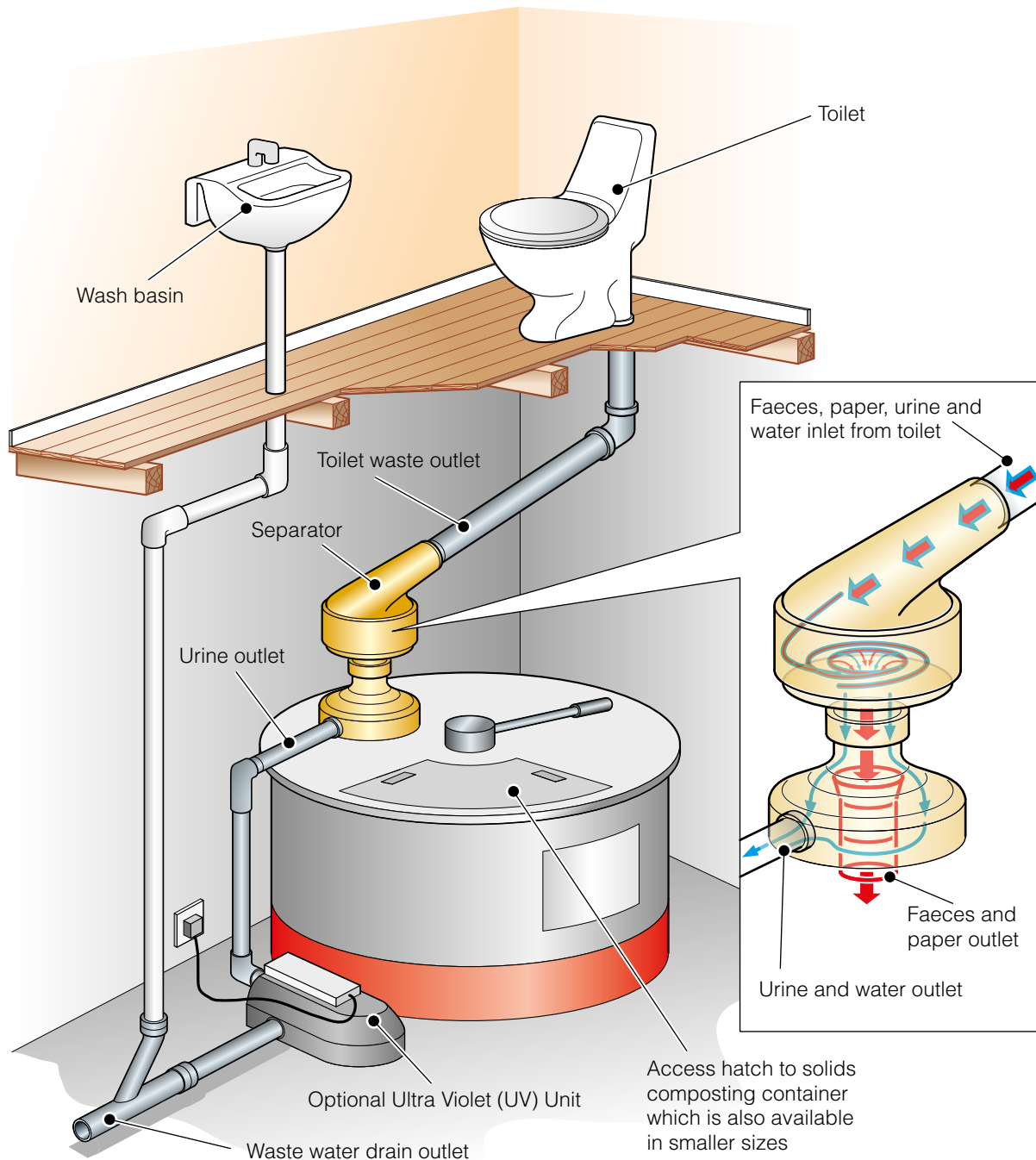

## Links

[http://www.naturbauhof.de/lad\\_komp\\_aqua.php](http://www.naturbauhof.de/lad_komp_aqua.php)

# Blue Diversion Toilet

The Blue Diversion Toilet is a dry urine-diverting toilet with the additional feature of an integrated water recovery/ recycling that allows for the comfort of hand washing, anal cleansing and toilet cleaning. Refer to the link below for full details.

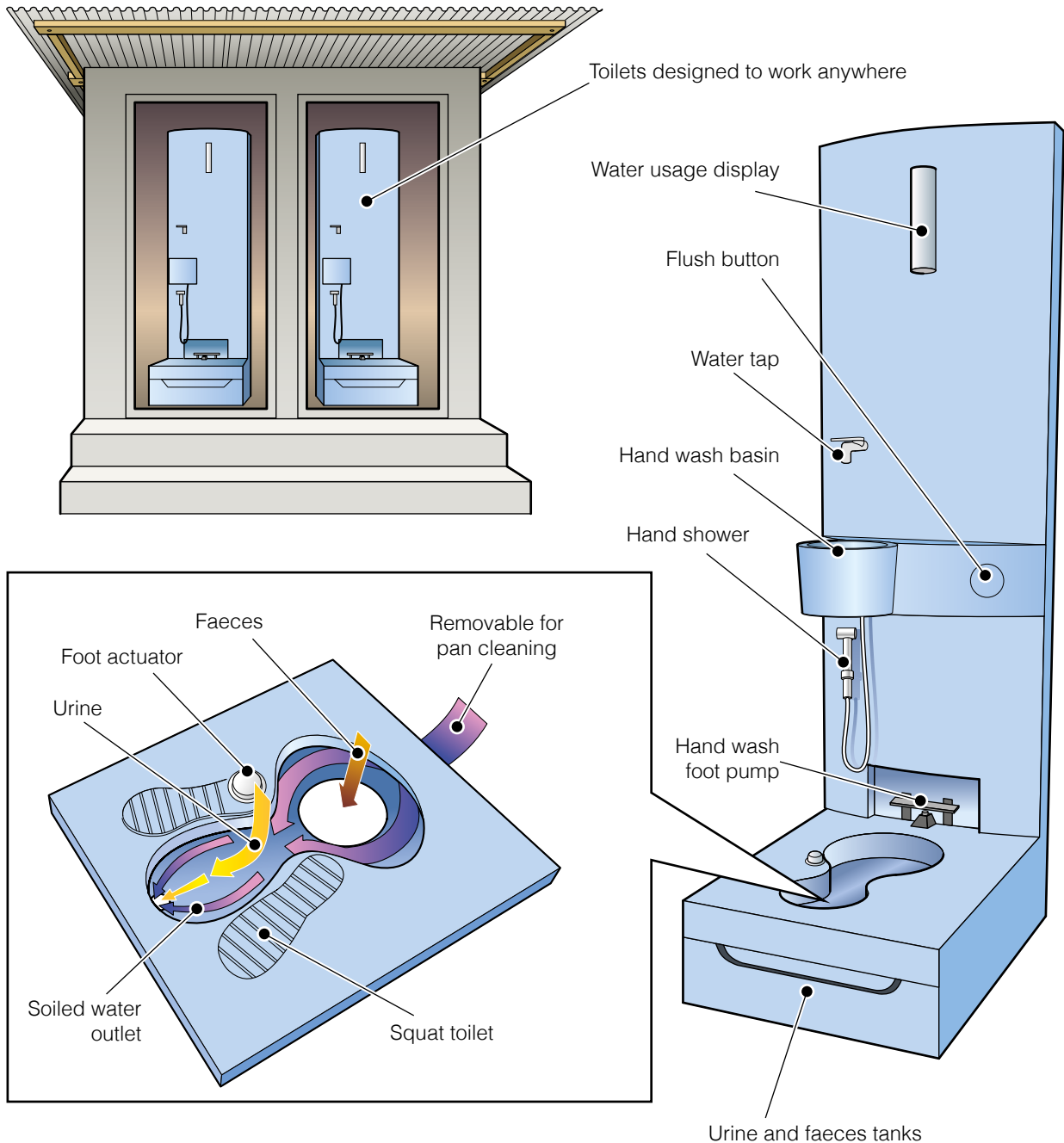

## Links

<http://www.bluediversiontoilet.com>

# Bipee\*

The Bipee is an integrated water-saving bidét and urinal toilet. With the separation of urine the Bipee requires less than 0.5 litres for flushing against other conventional water-saving toilets which require more than 2.5 litres per flush.

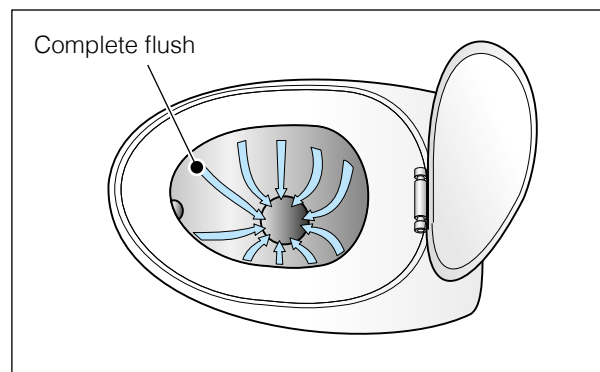
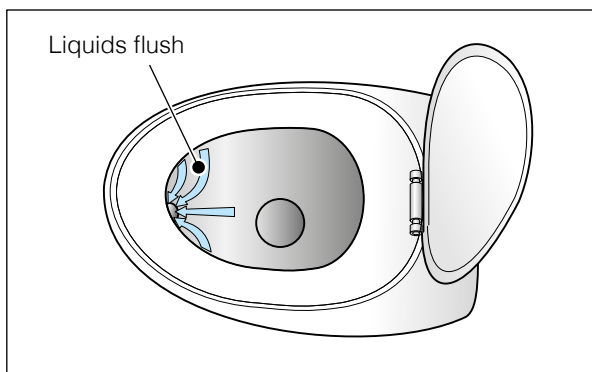
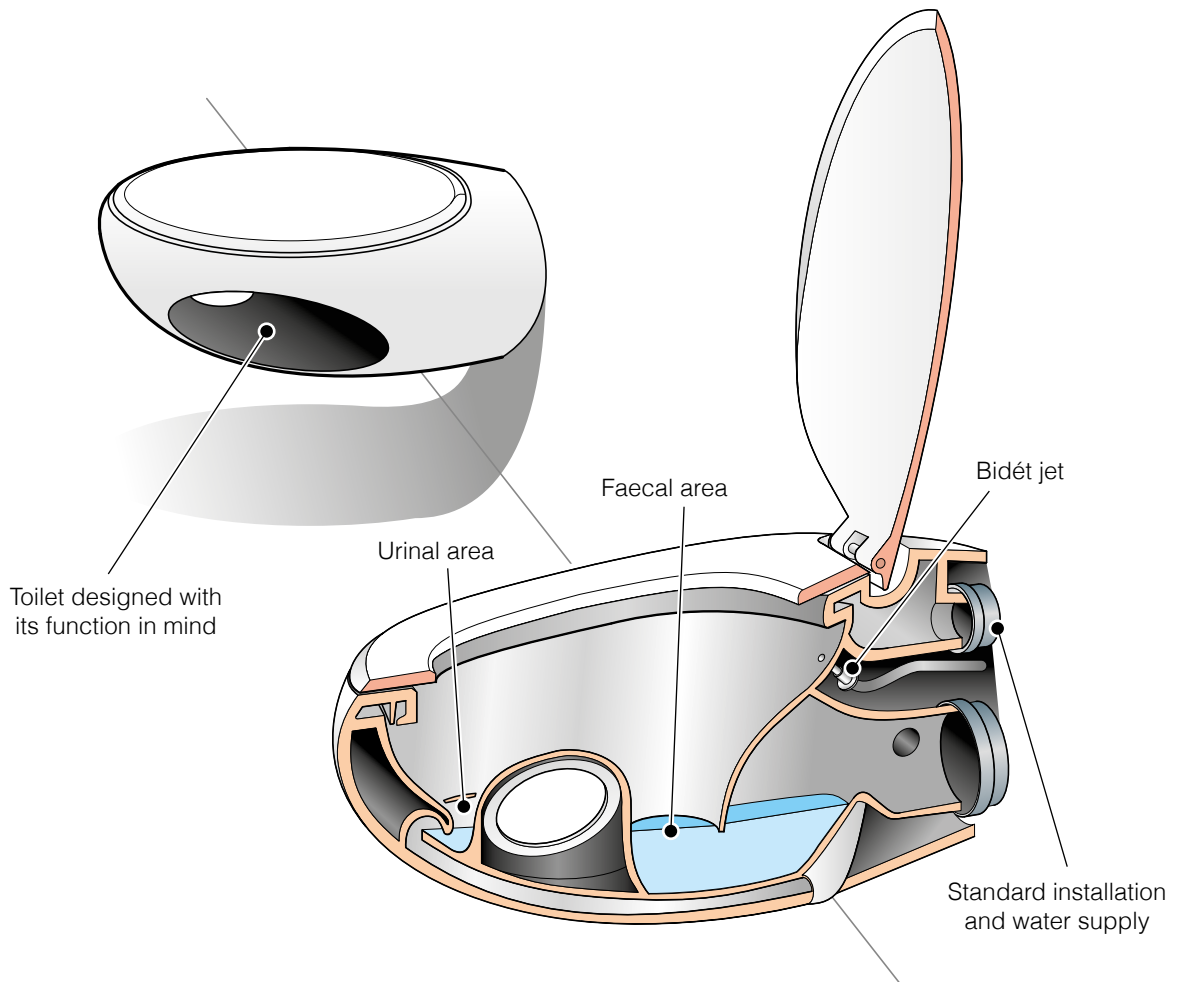

## Links

<http://www.m-attia.com/2010.html>

# Built-in Composting System

Designed by Amos Bender, this composting system has an indoor commode, with an outside soil bin, and outside access to a waste container. The system incorporates a small amount of soil mixed with the faeces to assist with composting. (See also pages 19 and 28.)

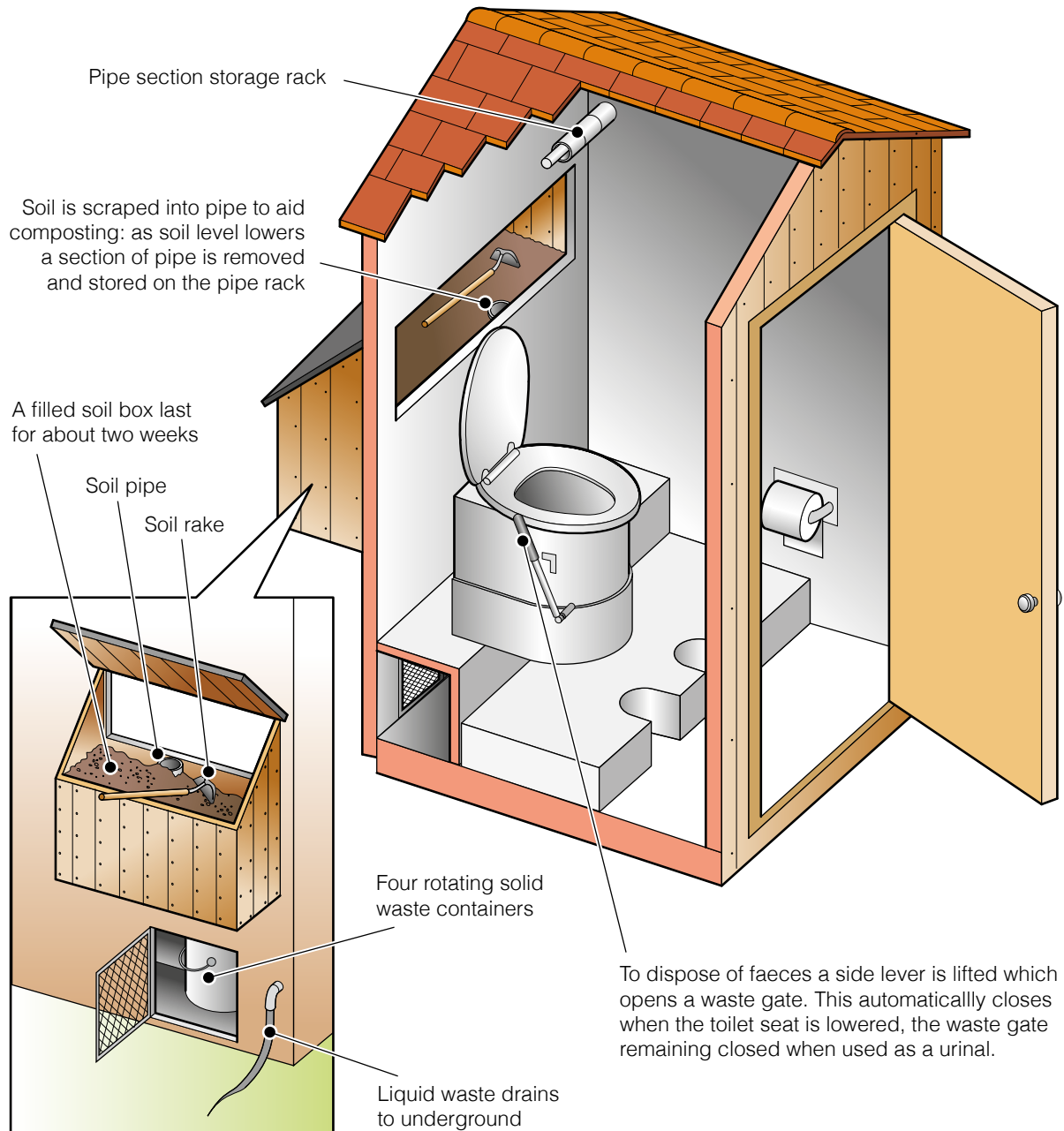

## Links

<http://www.exploringnaturespossibilities.com/>

# Camping Toilets

Camping toilets are portable and are produced by various manufacturers. They usually use chemical solutions as a primary means of treatment at the point of use. A world-wide-web search query produces a comprehensive list of links.

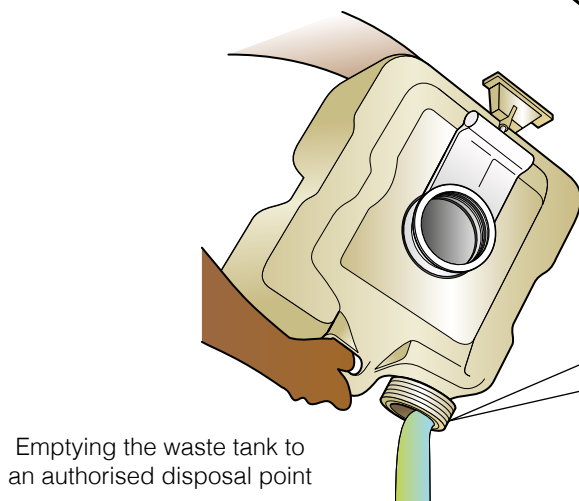
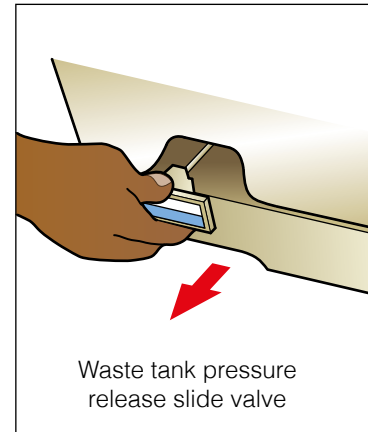
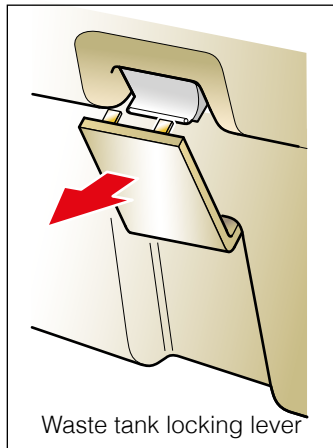
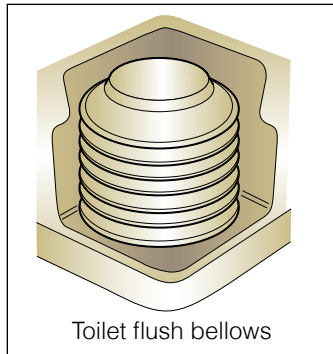

## Links

<http://www.youtube.com/watch?v=vhELPhb--Lg>

<http://www.kampa.co.uk/instructions/accessories/portaflush>

# Caravan Toilets

Caravan toilets are similar to camping toilets but are designed to be integrated into the chassis of the vehicle. They are removed for periodic emptying at chemical disposal points.

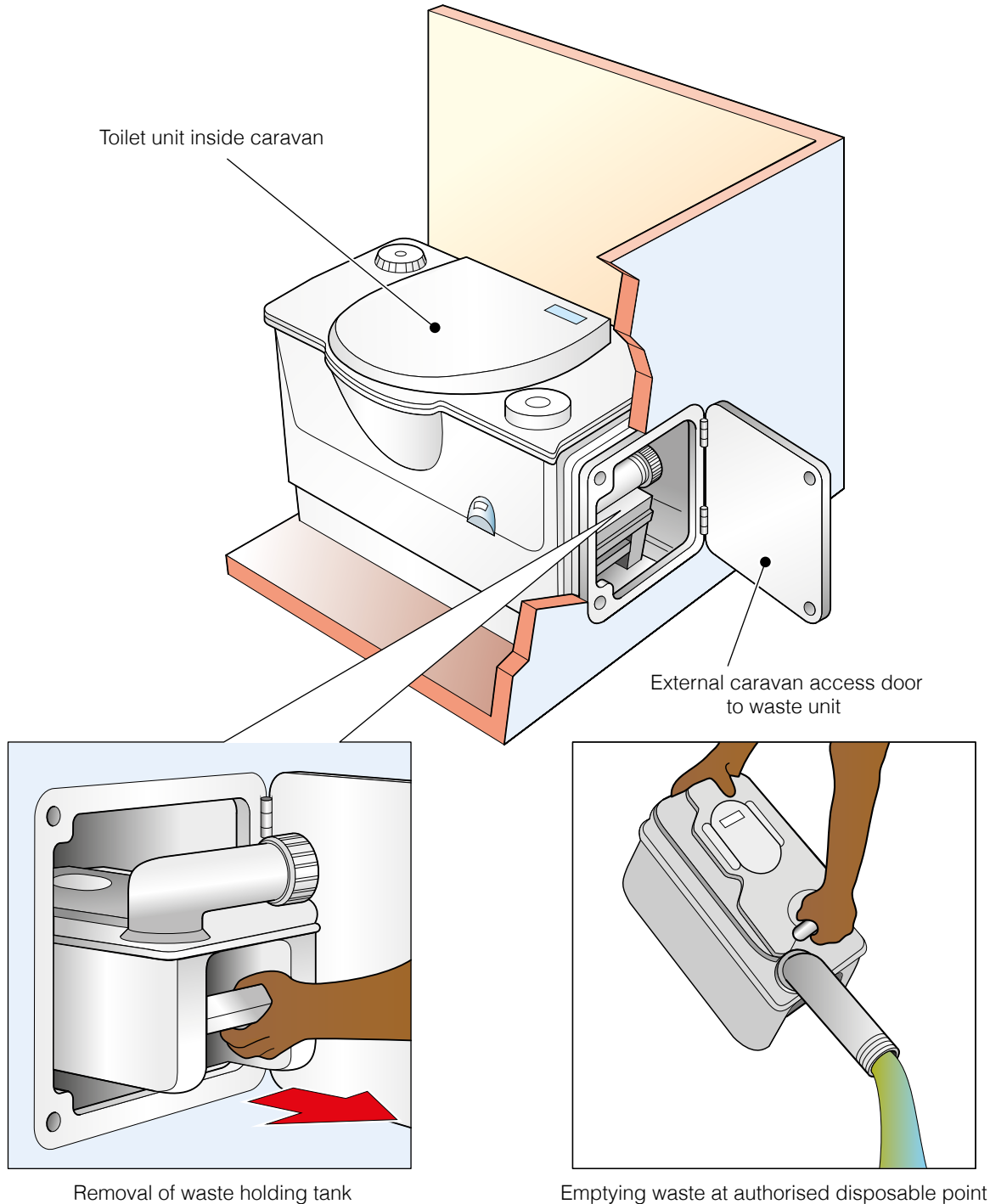

## Links

<http://www.youtube.com/watch?v=CQ5Vvjqnjgg>

<http://www.thetford.com>



# Cinderella Toilet

Cinderella toilet systems are incinerating toilets, in which the waste products are converted into sanitized ash by combustion at high temperatures.

Start button to commence the combustion process

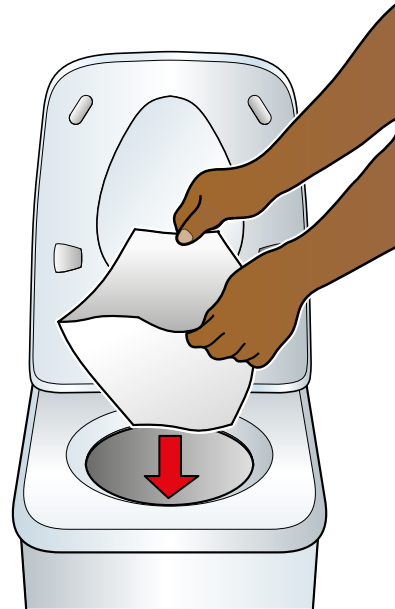
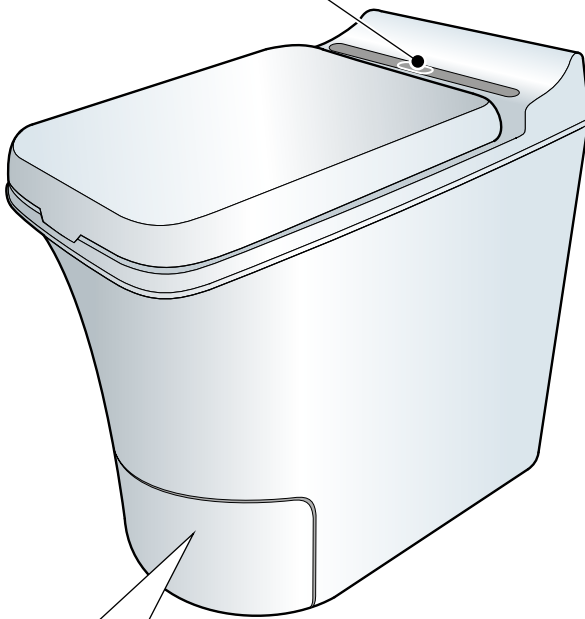

Each time the toilet is used, a purpose bag supplied by the manufacturer must be placed in the toilet bowl. After use, the bag and its contents drop into an ash bin in the combustion chamber.

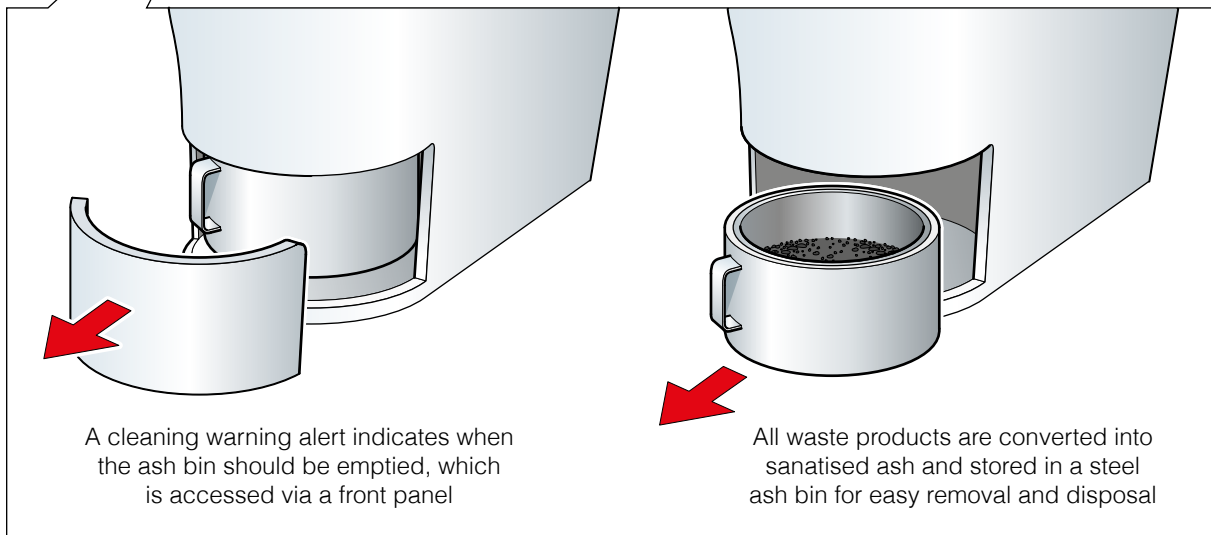

A cleaning warning alert indicates when the ash bin should be emptied, which is accessed via a front panel

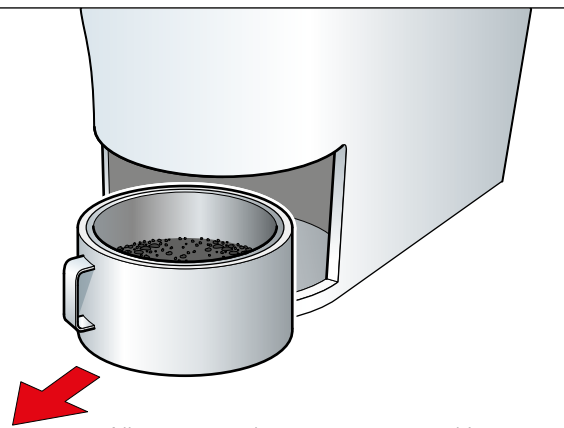

All waste products are converted into sanitised ash and stored in a steel ash bin for easy removal and disposal

## Links

<http://www.cinderella.as>

# Drysan Waterless Toilet

The Drysan waterless and urine diversion toilet system is intended for use in areas where sewerage lines and sewerage works are unavailable, have been damaged, or where chemical toilets are currently used. The system may also be used where households have a limited supply of water. The use of the Drysan extends to informal housing, low-cost housing, smallholdings, disaster areas, water challenged areas, military facilities, lodges, farms and many other areas deprived of water toilet facilities.

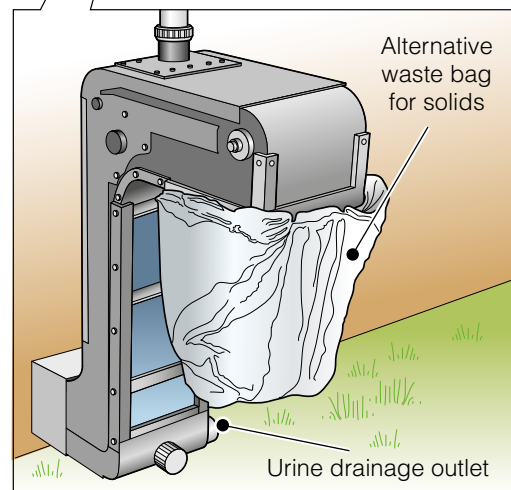
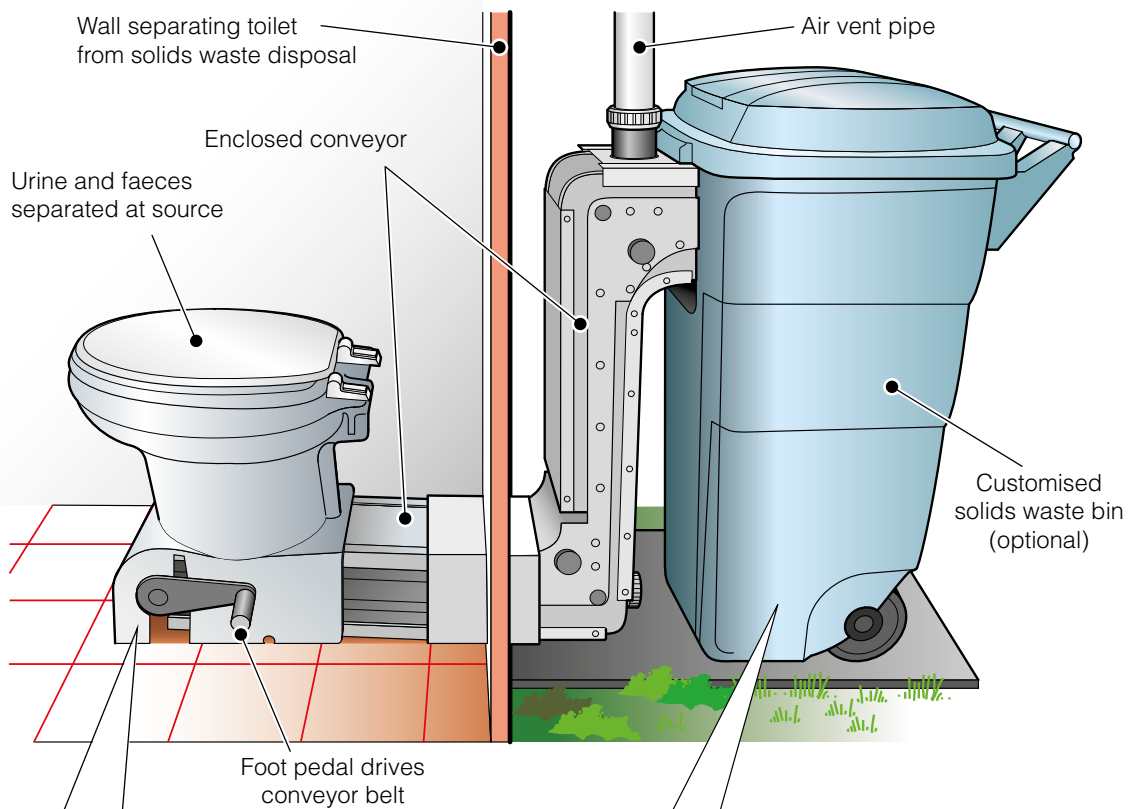

## Links

<http://drysan.co.za/>

# EkoToi

Designed for both rural and urban areas in India, the EkoToi is the result of a Masters final project in product design from Parag Deshpande, featuring urine separation.

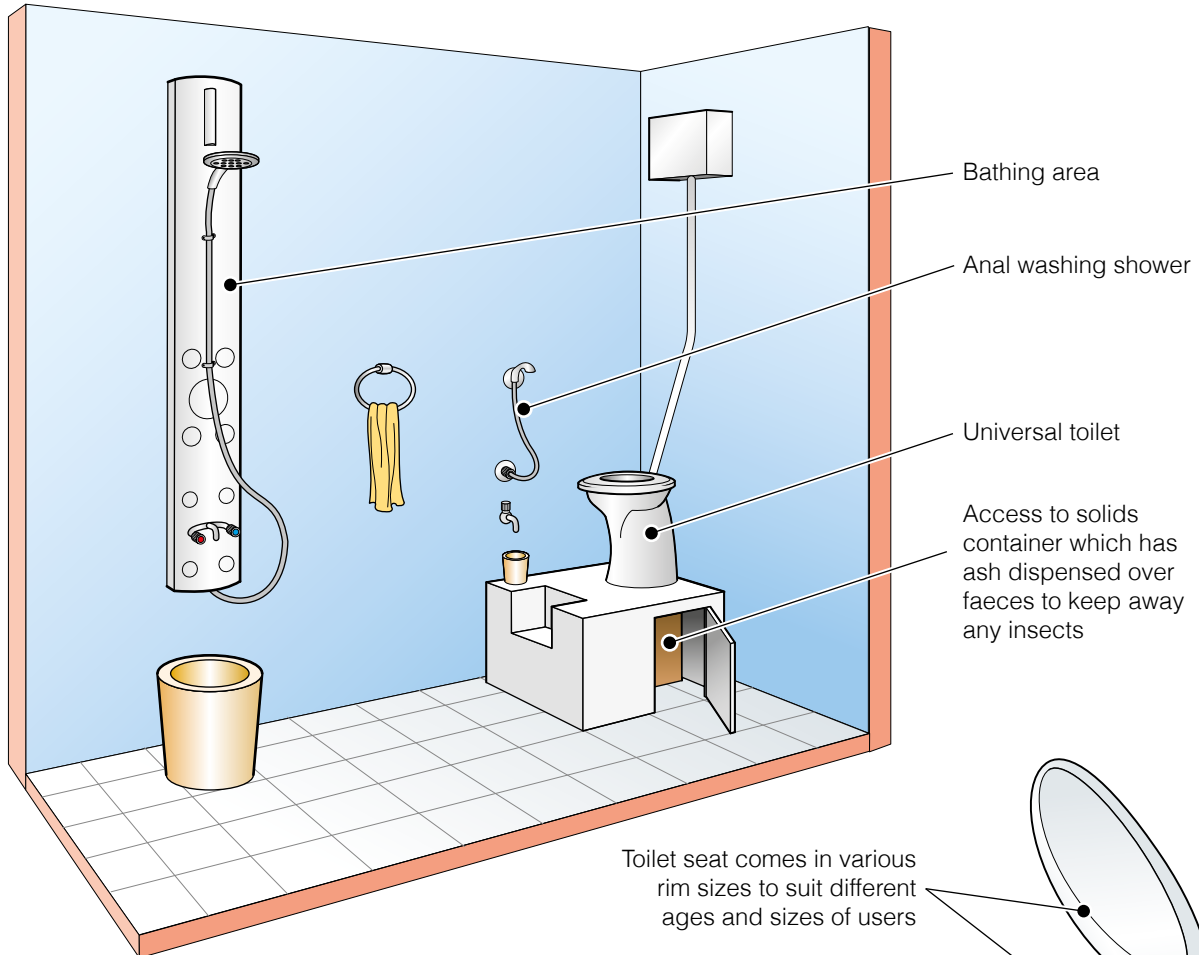

Urine diverts to bowl front and subsequently to a central storage tank

Hinged cover opens for faecal use (closed when used for anal washing), which is deposited in a container below the toilet

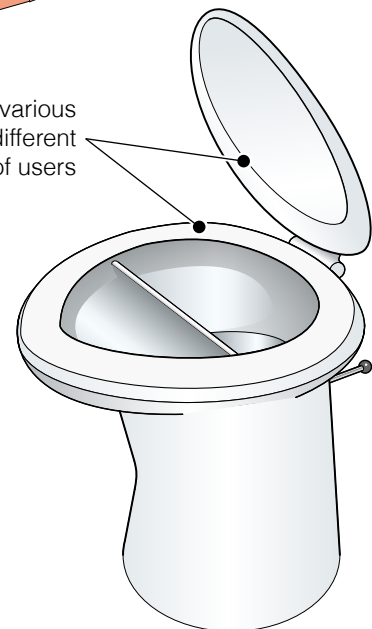
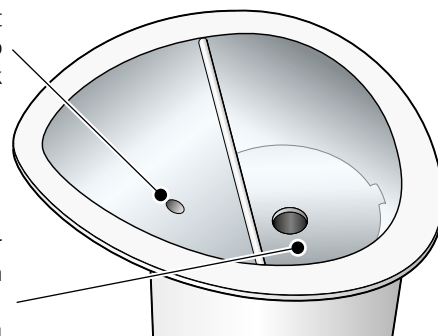

## Links

<http://vimeo.com/user2830873>

# Envirosan

Based in South Africa, Envirosan provides a comprehensive range of plastic injection moulding products, concentrating specifically on environmentally-friendly sanitation systems.

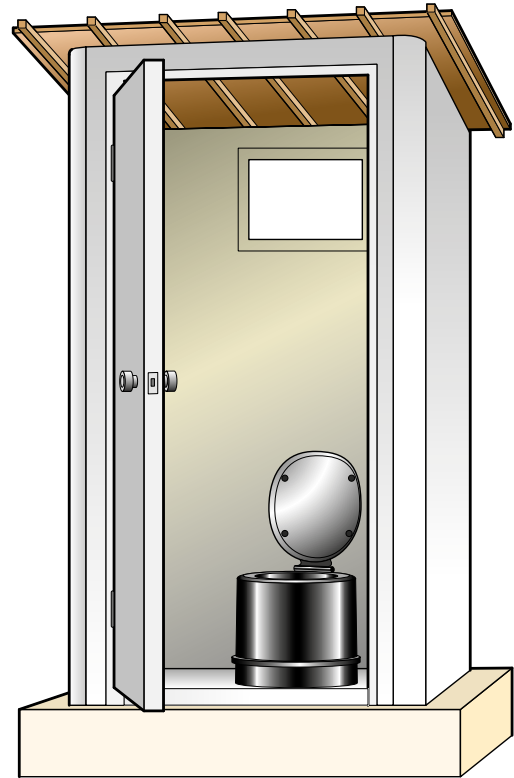

## Links

<http://envirosan.co.za/>

# Eram Delight

Delight, the automatic public toilet unit developed by Eram Scientific Solutions Pvt. Ltd is intended to improve the sanitation facilities in urban areas, especially in developing countries. In addition to its automated toilet facilities the unit can also display 100sq ft of illuminated advertisement boards on its outer surface. This can act as a valuable source of advertisement revenue in addition to the admission collection for those operating the toilet. The unit can be connected to existing water and drainage facilities or a bio-membrane reactor which can recycle the wastewater for flushing purposes.

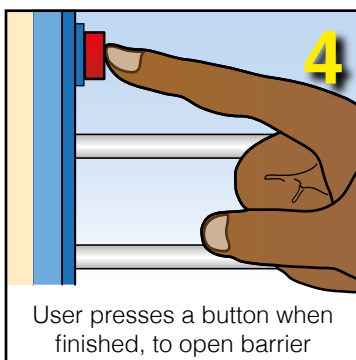
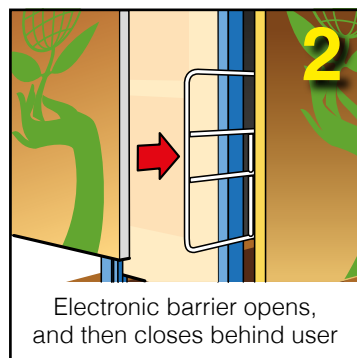
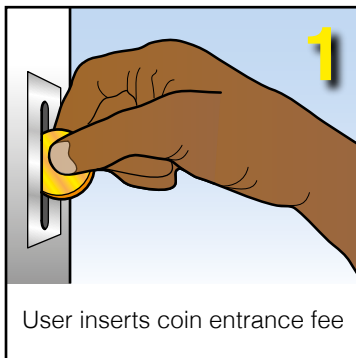

## Links

[http://www.susana.org/docs\\_ccbk/susana\\_download/2-1624-baby.pdf](http://www.susana.org/docs_ccbk/susana_download/2-1624-baby.pdf)

<http://www.youtube.com/watch?v=1bBhO7AQZao>

<http://www.youtube.com/watch?v=IYsygg1ZJAg>

# Fresh Life Toilet

Sanergy design and manufacture low-cost, high-quality sanitation facilities. Developed by their engineers, the Fresh Life Toilet (FLT) is pre-fabricated at their local workshop. The FLT qualities users value most include the high-quality materials that are easy to keep clean and maintain; the small footprint that enables them to be installed close to homes; and essential features such as hand washing facilities.

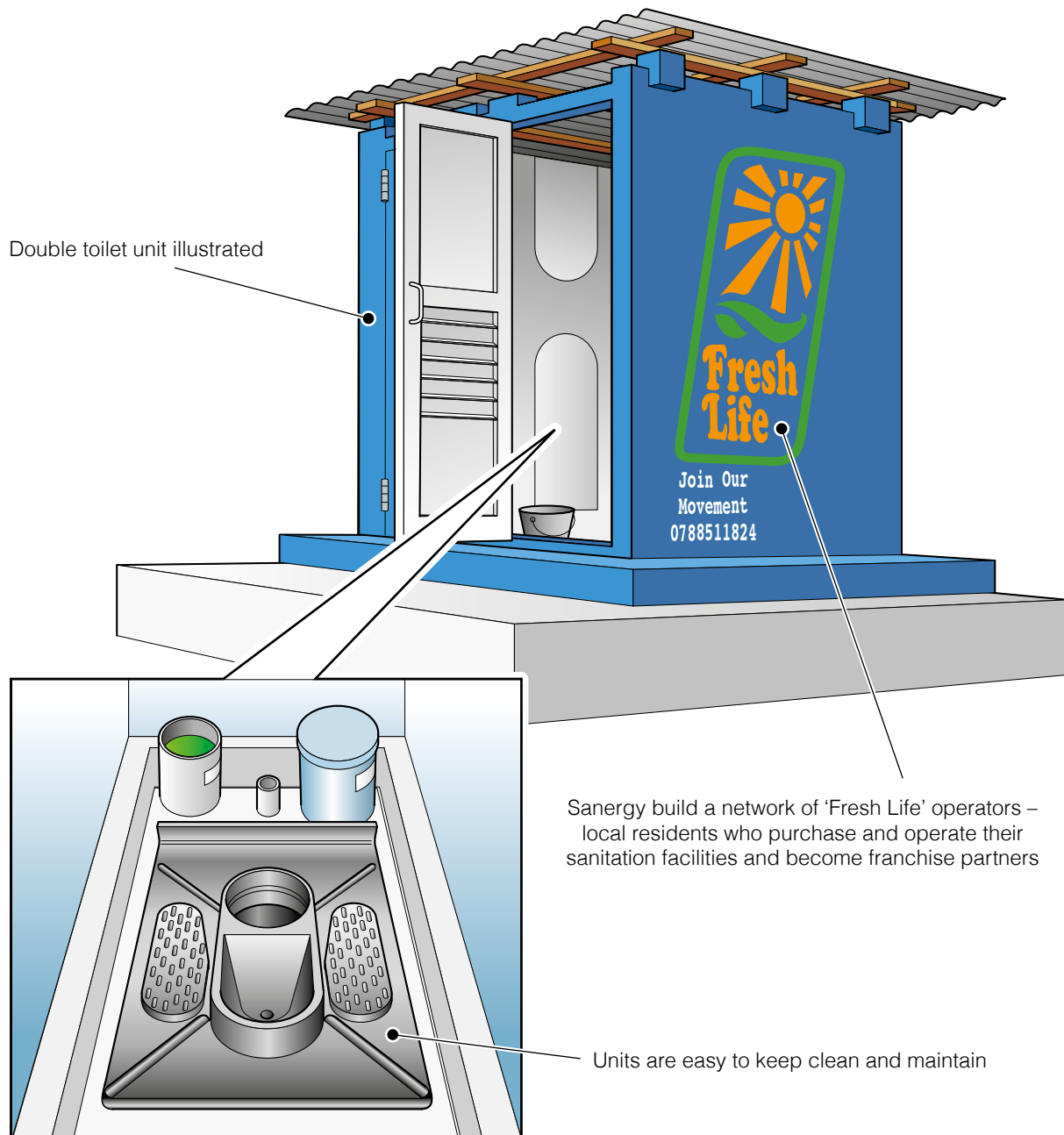

## Links

<http://saner.gy/>

<http://www.youtube.com/watch?v=unTc-rID9LI>

<http://www.flickr.com/photos/gtzecosan/sets/72157629321008423/with/6879710585/>

# Ghanasan

The Ghanasan Human Centered Design Research Project is a collaboration between Unilever, Water and Sanitation for the Urban Poor (WSUP), and IDEO to develop new products and services for in-home sanitation in Kumasi, Ghana.

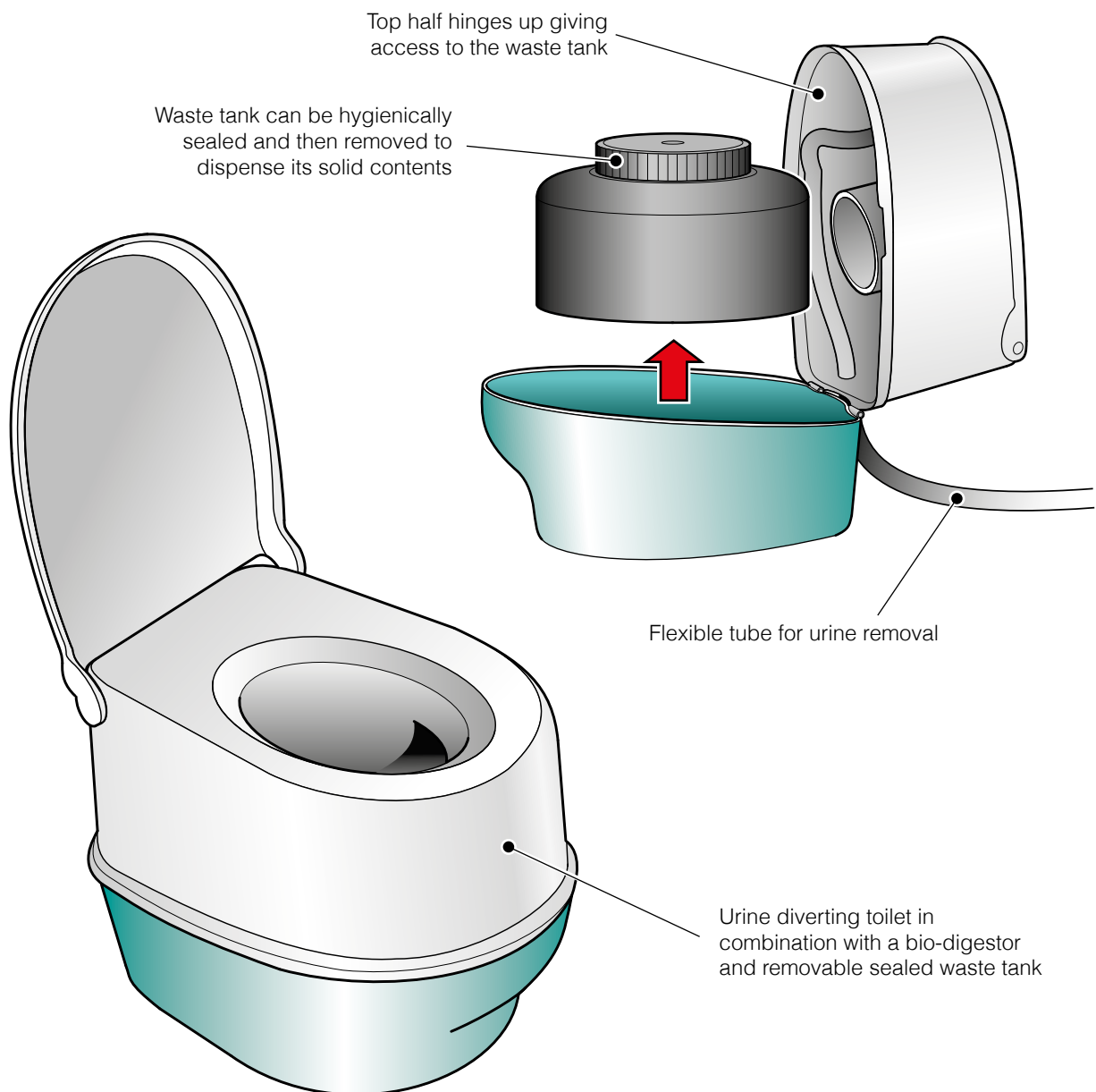

## Links

<http://ghanasan.wordpress.com/>

<http://www.ideo.com/work/human-centered-design-toolkit/>

# Green, Portable Eco-toilet\*

The eco-toilet provides a clean, portable sanitation solution for refugee camps. The waste solution can be combined with mobile shelters. Made of roto-moulded biodegradable plastic and ceramic, the toilet bowl is designed to provide comfort.

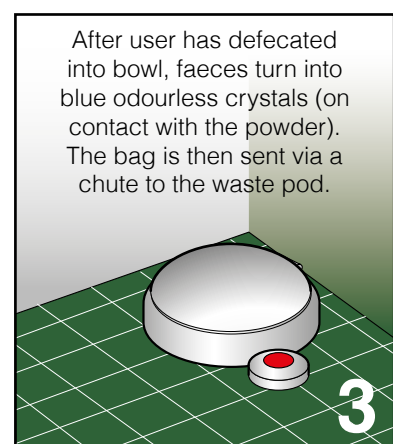
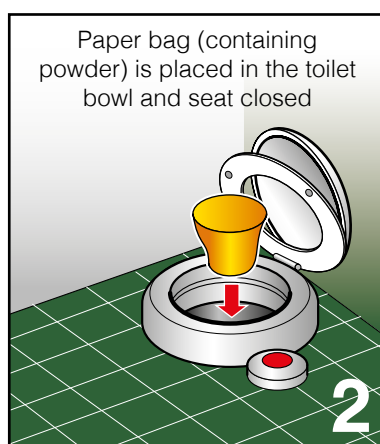
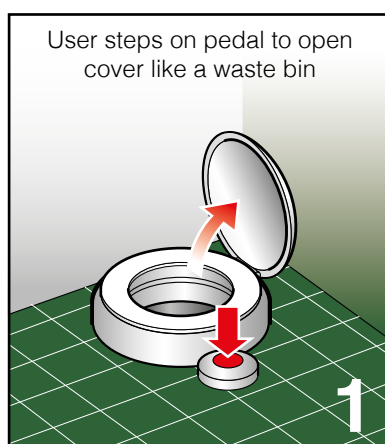
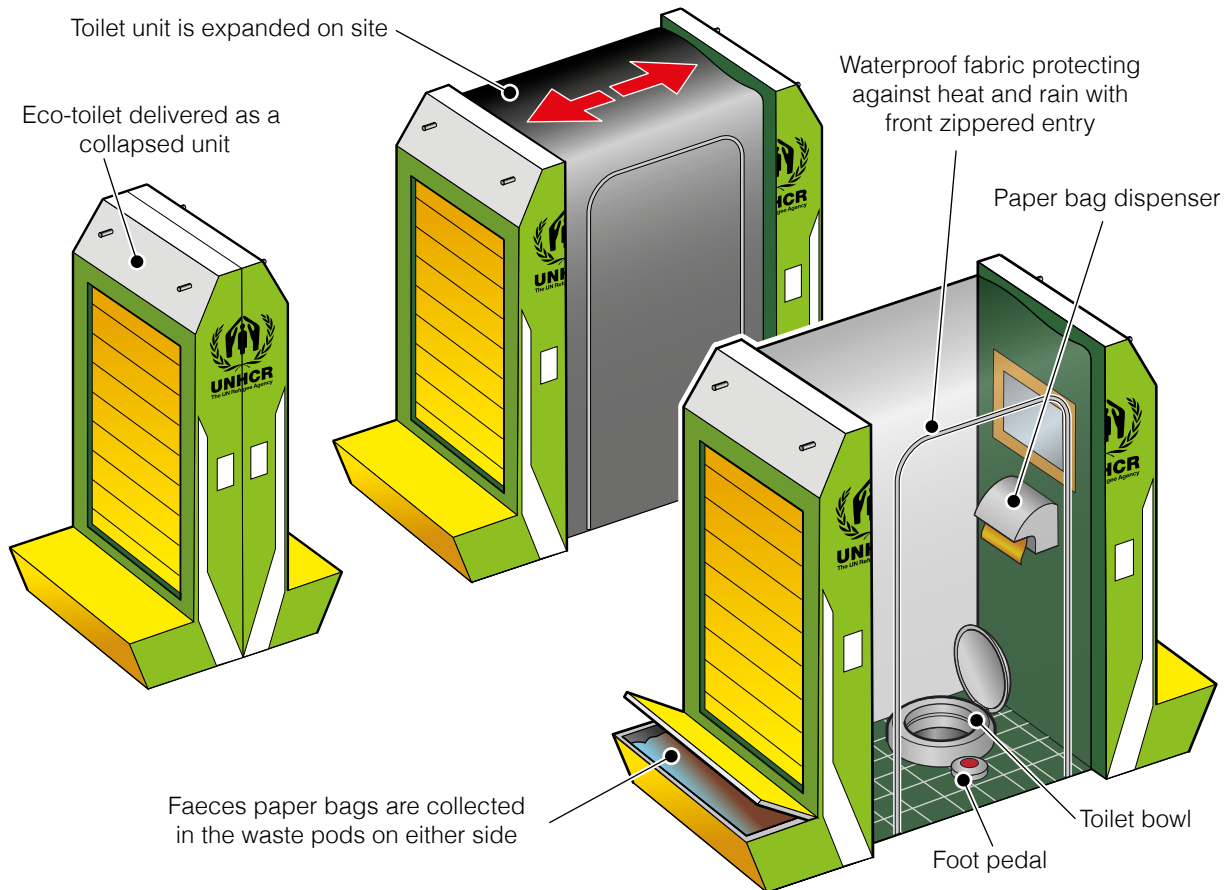

## Links

<http://www.igreenspot.com/green-portable-toilet-an-eco-friendly-waste-disposal-area/>



# Hightech Composting Toilet: Ecodomeo

Ecodomeo dry toilets separate the liquids from the solids. Liquids are evacuated through the household used water system. Solids are evacuated to a closed space where they are then reduced to compost by earthworms.

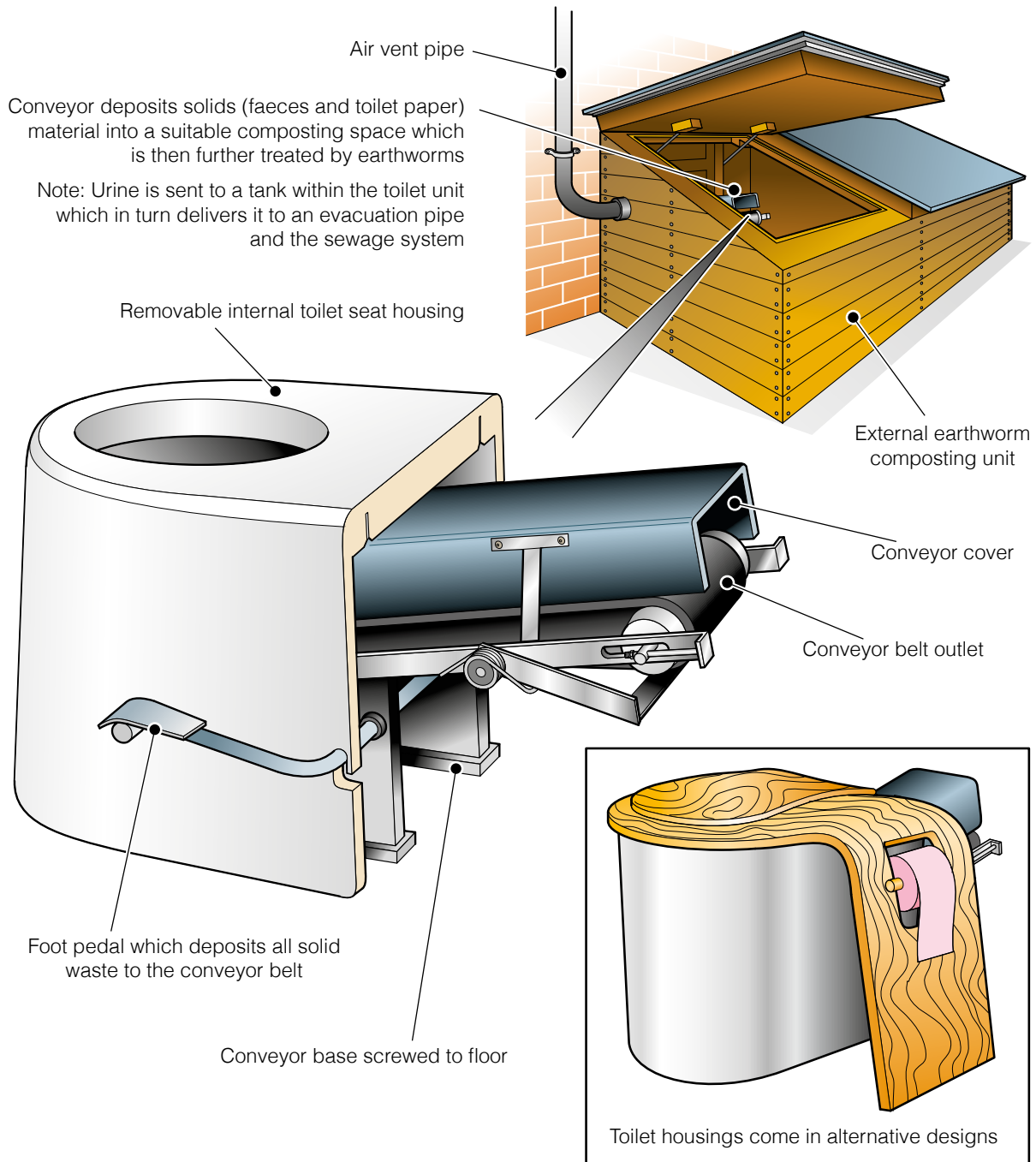

## Links

<http://www.ecodomeo.com/english/>

# IDE EZ Latrine

The Sanitation Marketing Pilot Project carried out by IDE Cambodia's WATSAN team is designed with the overall objective of creating rural household demand for sanitation, and linking this demand to local suppliers who have been educated, trained and supported to deliver sustainable, low-cost latrines. The end result will be a continually developing and thriving private marketplace that satisfactorily addresses the need for rural sanitation.

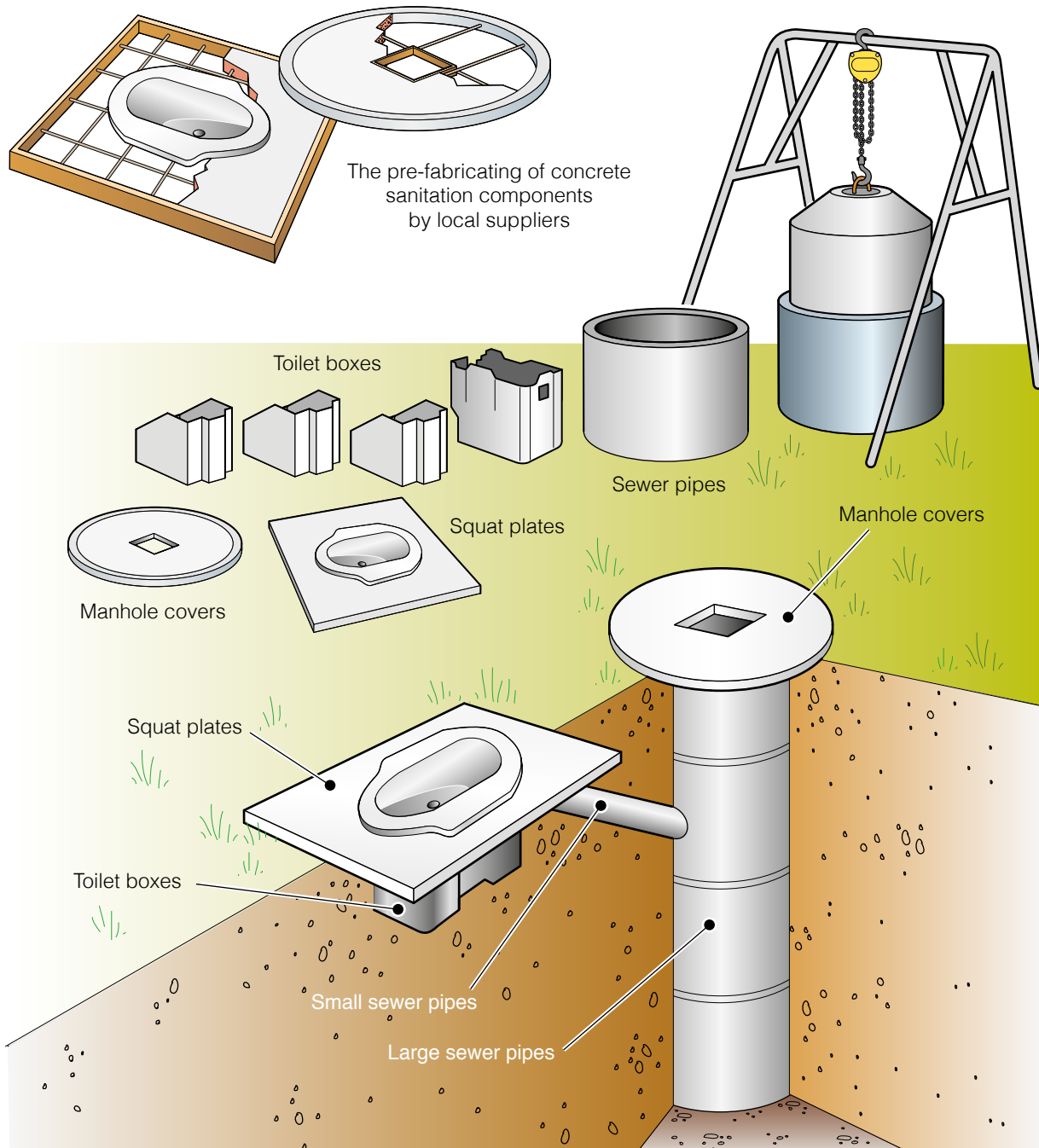

## Links

<http://www.youtube.com/watch?v=zloOePIhQzc>

# Indoor Self-contained Toilet

Another system from Amos Bender, this is a soiless, largely waterless, self contained, indoor commode system for use in power outages, cabins, or simply for use in homes. (See also Pages 6 and 28).

Wash and flush nozzle

Storage of Santi-fresh disks for solid waste disposal

To empty urine and solids, the toilet seat unit must be lifted straight up to reveal the two waste containers

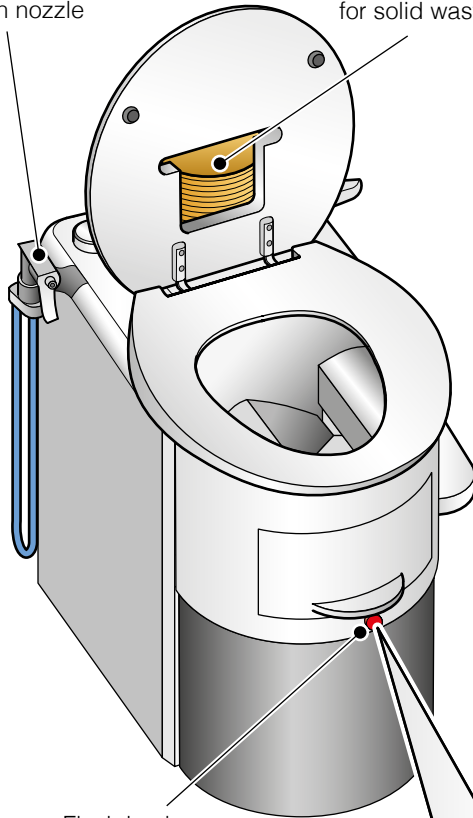

Urine container

Solid waste container with internal bag liner

Flush knob

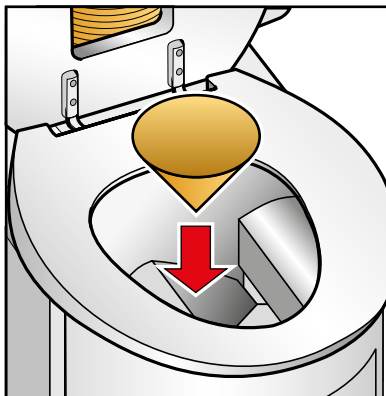
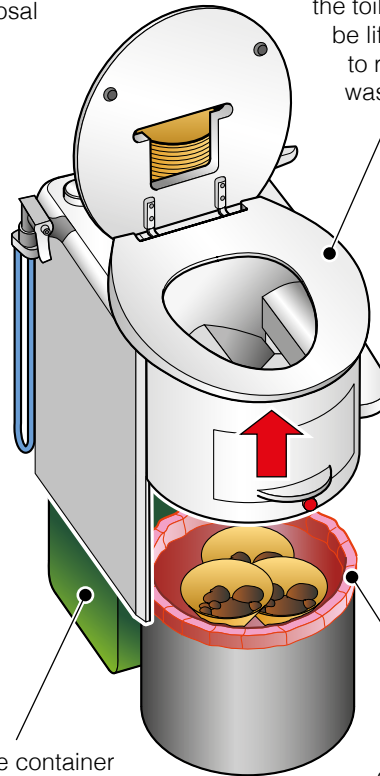

New Santi-fresh disk used every time solids are deposited in toilet

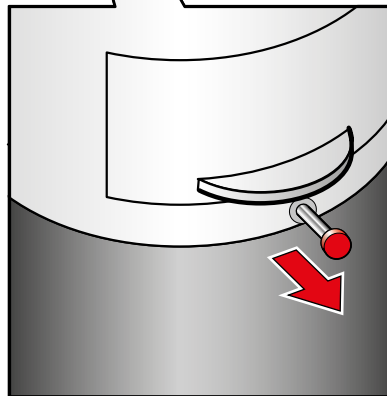

Flush knob drops used Santi-fresh disk into the waste container

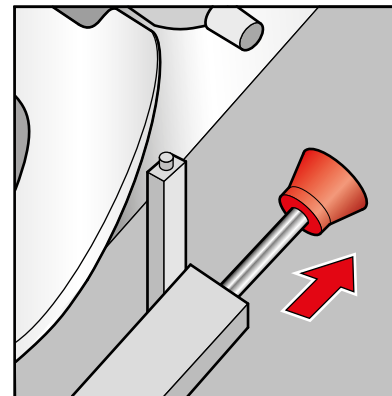

Second knob on right of toilet opens the waste gate for next solids

## Links

<http://www.exploringnaturespossibilities.com/>

# Intestinal Toilet

With the intestinal toilet, excreta falls down a vertical chute onto one end of a specially designed helical screw conveyor. Every time the toilet lid is lifted, a mechanism rotates the conveyor. With each rotation the excreta slowly moves along, taking approximately twenty five days before falling into a reusable collection bag. It takes six months for the bag to fill with dry and odourless waste. Through the ventilation pipe, adequate airflow is provided for the dehydration, evaporation and deodorising process.

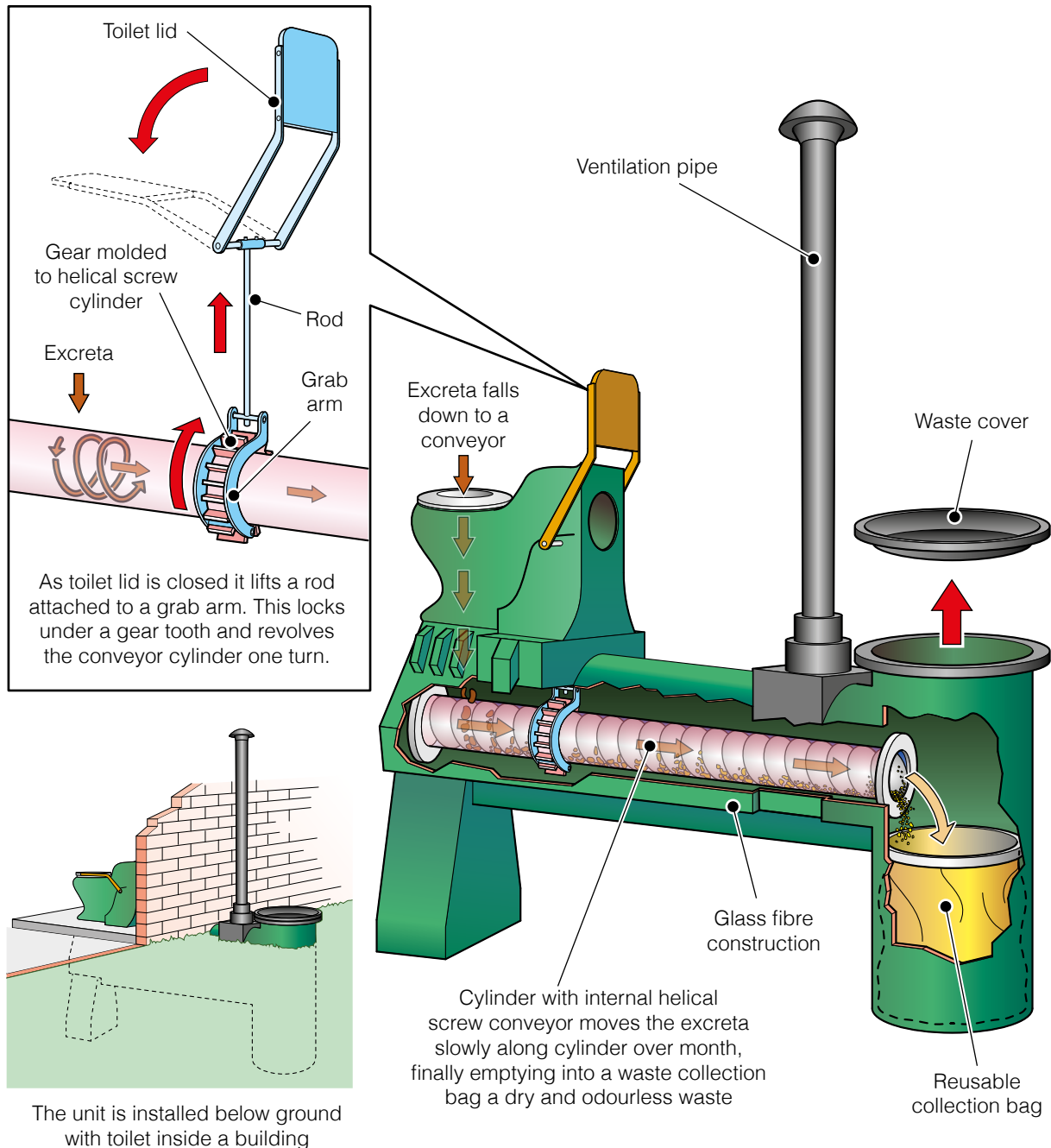

## Links

<http://www.youtube.com/watch?v=gPummZRR2Cg>

<http://www.ecosan.co.za/>

# Locus Toilet

The Locus toilet is a biological system for waste treatment in which excess liquid evaporates and the faeces are composted by natural microorganisms. A controlled supply of heat and air and frequent stirring accelerates the decomposition of the waste, producing a valuable fertilizer.

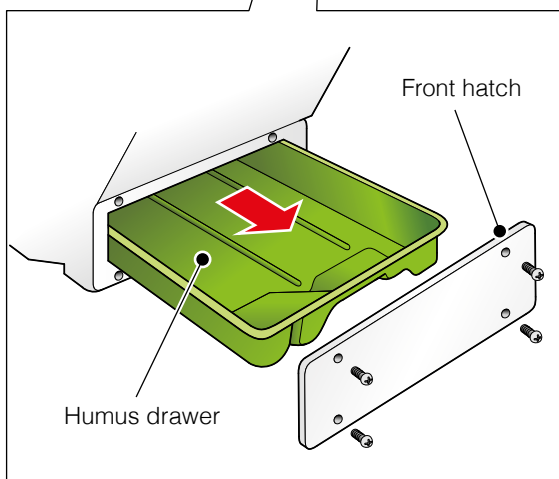
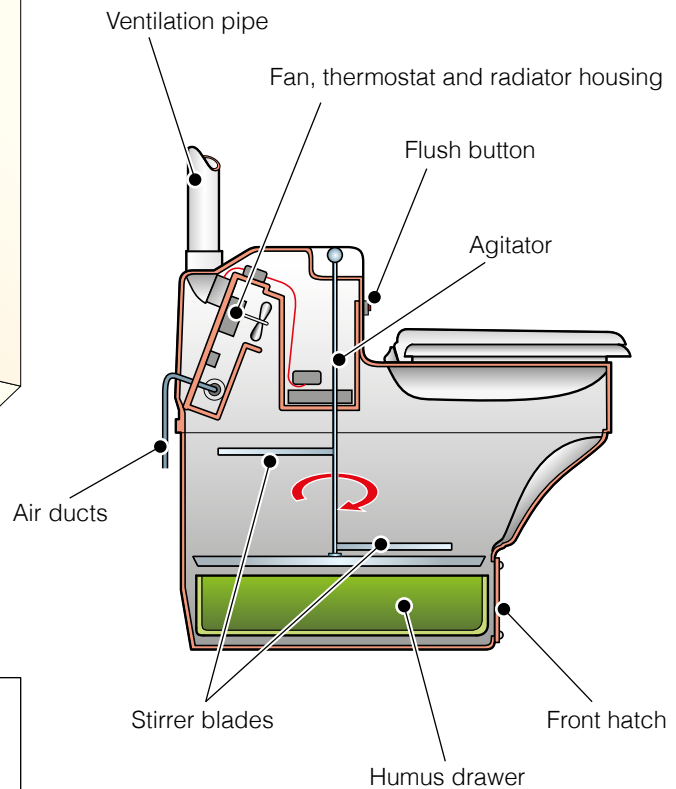
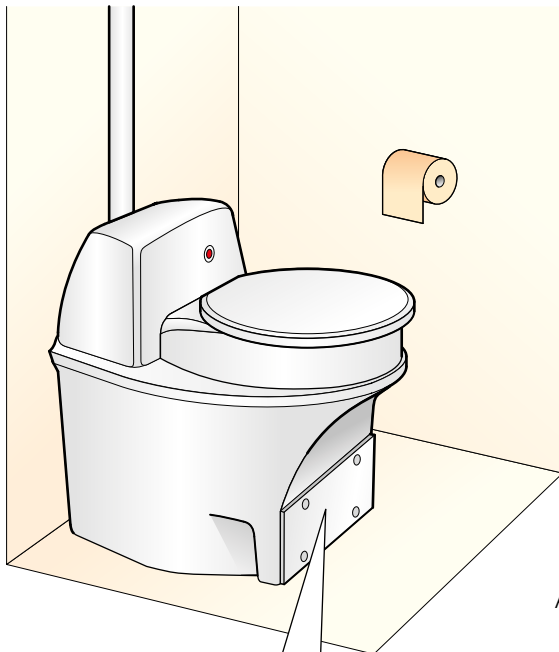

## Links

<http://www.locus-toilette.de/umwelt/umwelt.htm>

# Loowatt Toilet

The Loowatt toilet uses a simple, patent-protected mechanical sealing unit to contain human waste within biodegradable film in the most efficient way possible, with a unique odour-inhibiting system. The waste is then stored in a cartridge beneath the toilet, for periodic emptying, which can be weekly or daily, depending upon level of usage and capacity. The sealing unit can be built into toilets of any shape, size and specification, using off-the-shelf parts and local materials to maximize value. In addition, they also market a biodegradable digester for extracting methane gas from their cartridges for use in cooking.

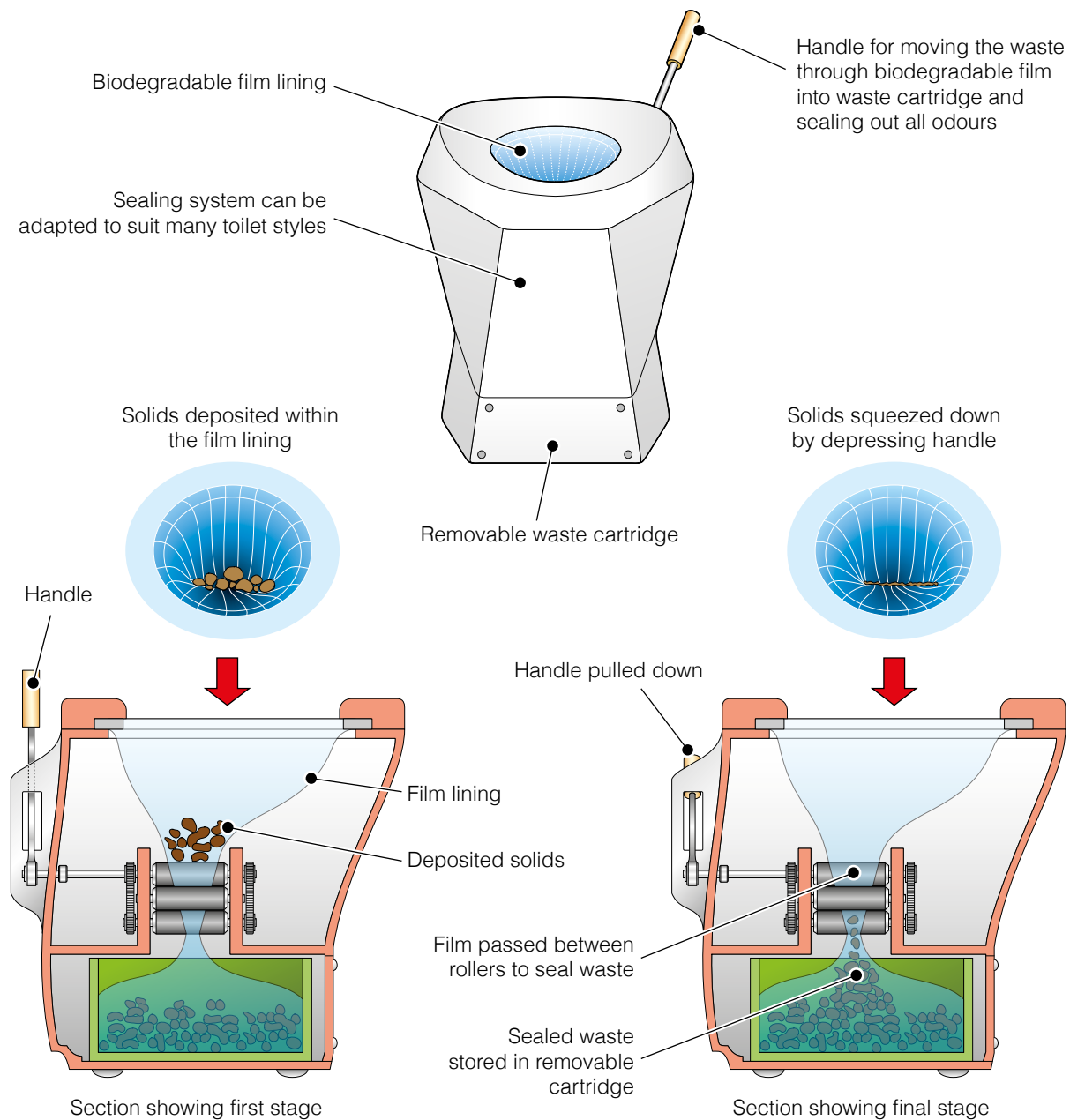

## Links

<http://www.loowatt.com>

# MoSan – Mobile Sanitation

GIZ Bangladesh and the German industrial designer Mona Mijthab developed a non infrastructure-based separation dry toilet for the urban poor in Bangladesh. Called the MoSan, the toilet is part of a sustainable sanitation system with collectors, transport, human waste treatment and reuse as compost fertiliser or biogas. No water or chemicals are required. The lightweight toilet can be carried and used at a convenient place and is also suitable in cases of emergency, like flooded areas. The toilet is designed for one family or household.

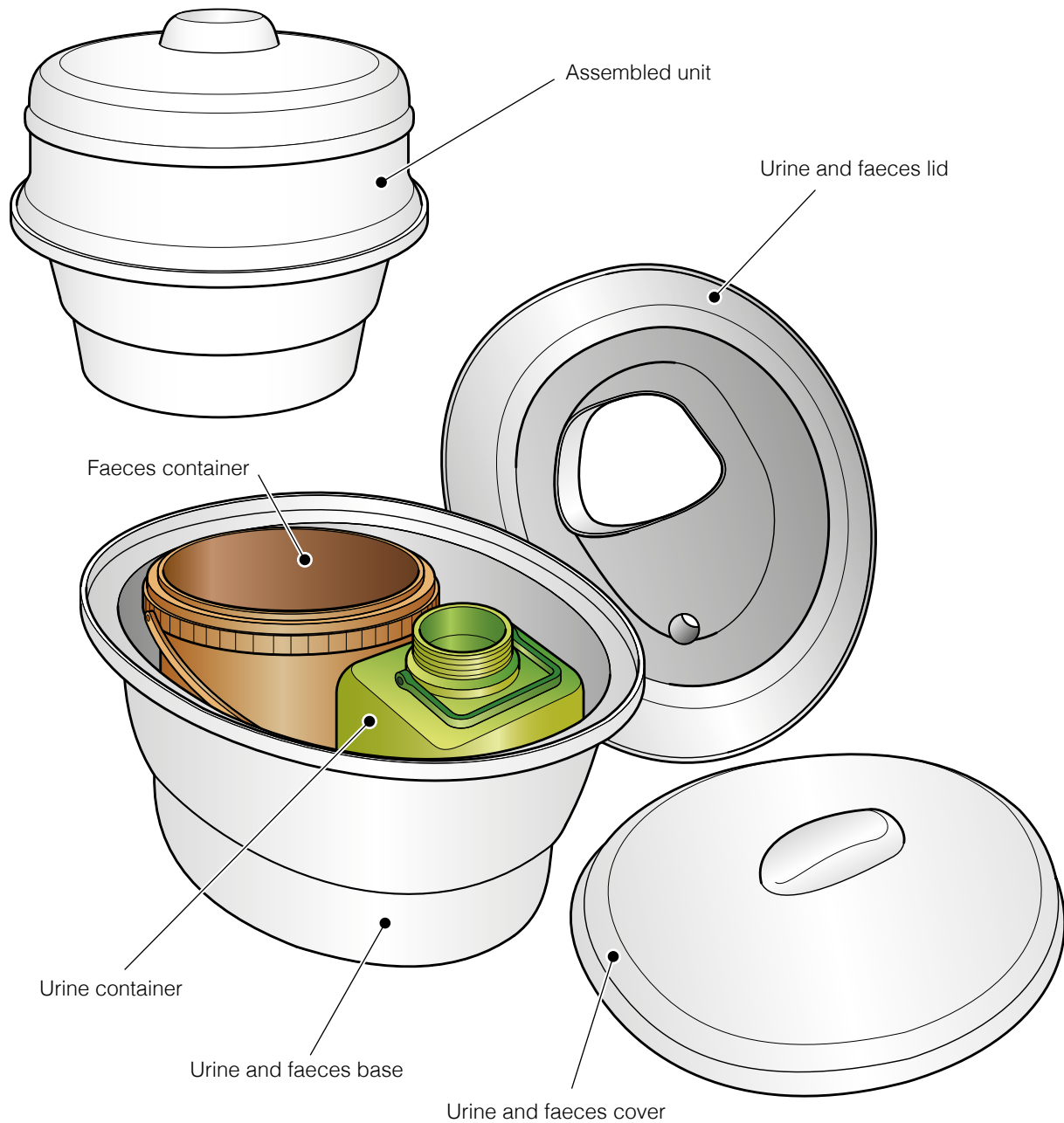

## Links

<http://mosan-bangladesh.tumblr.com/>

<http://www.susana.org/lang-en/library?view=ccbctypeitem&type=2&id=1237>

# Open Privy\*

A waterless composting toilet, the Open Privy can be installed outdoors or within a superstructure. If it is placed in the open, rainwater can be collected and allowed to filter down to a downpipe. Bent metal and willow sticks have been woven to cover the toilet to guard against weathering. A hinge that connects the toilet's inlay, seat, downpipe and cover masks the smell, letting air circulate freely.

The Open Privy serves as a good method of composting and enhances the top soil effectively to act as a natural fertilizer. Users can choose to either throw away the excreta collected or reuse it in the composting process.

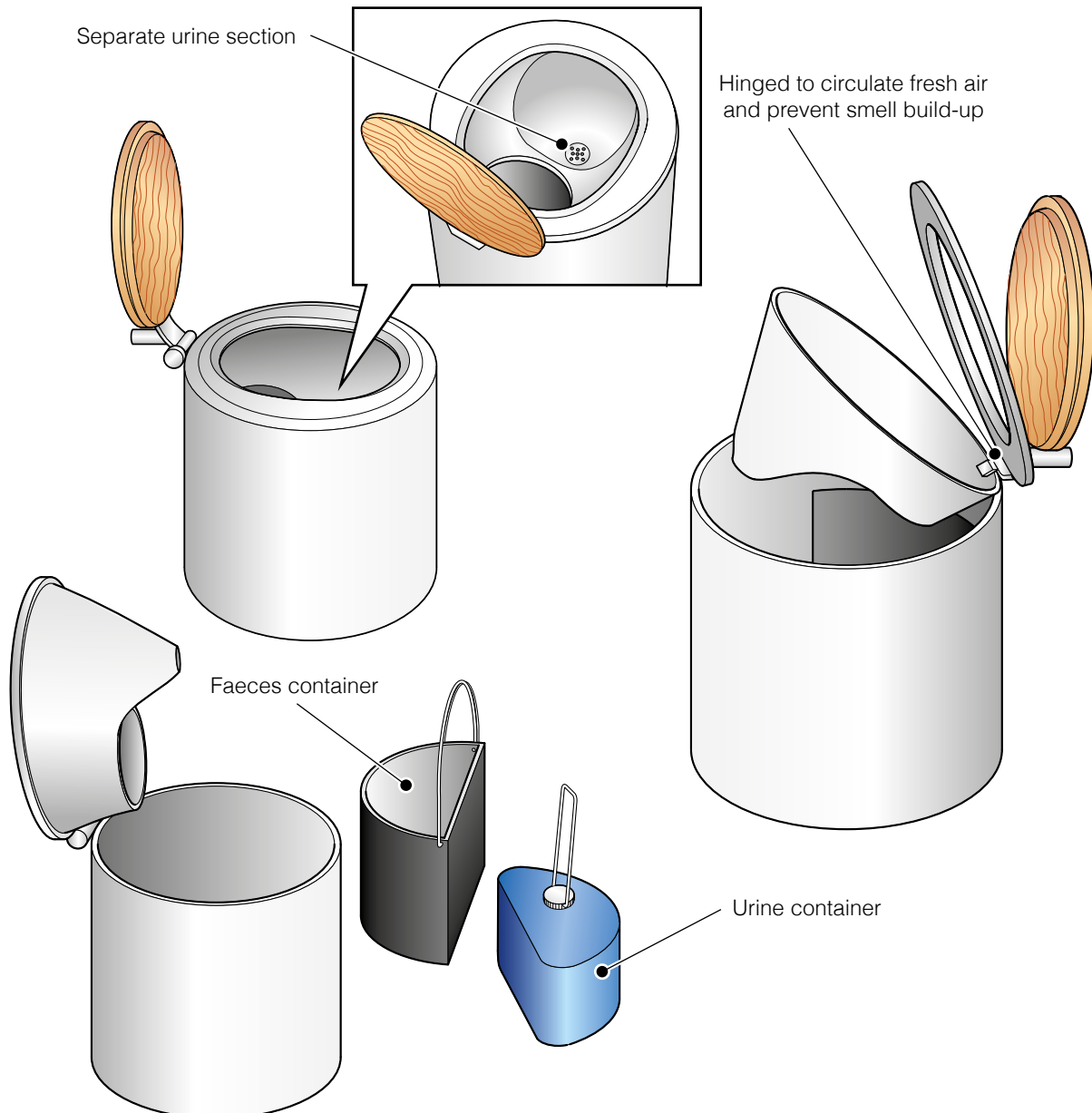

## Links

<http://www.youtube.com/watch?v=1LvsvLlnkN8>

<http://www.ecofriend.com/open-privy-waterless-toilet-helps-add-precious-top-soil.html>



# Otji Toilet

The Otji Toilet from Namibia uses the effect of surface tension to divert faeces and urine. The superstructure typically used is similar to that of a composting toilet.

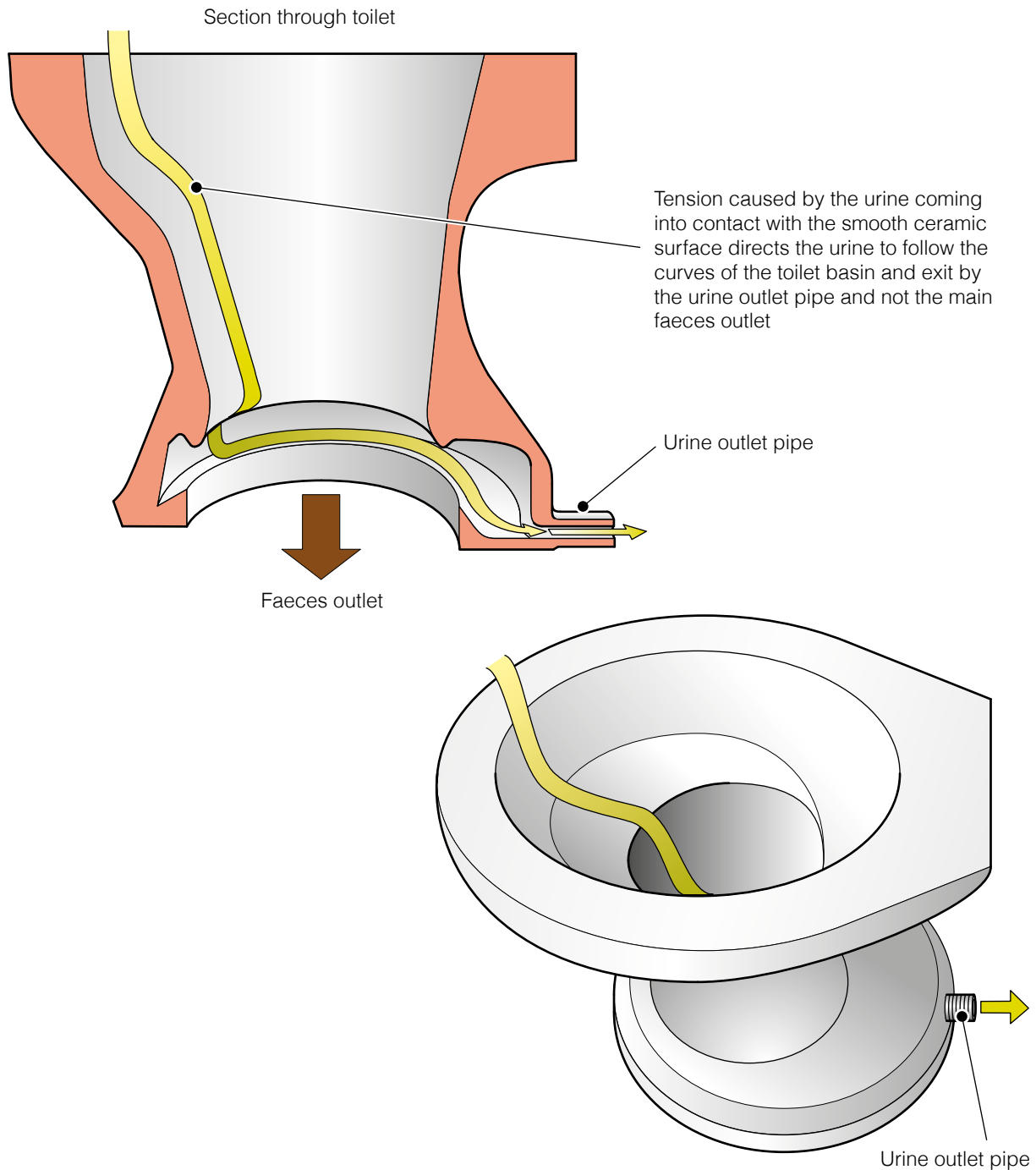

## Links

<http://www.otjitoilet.org/>

<http://www.youtube.com/watch?v=wvetp9F8G4U>

# Peepoo

Peepoo is a personal, single-use, self-sanitising, fully biodegradable toilet that prevents faeces from contaminating the immediate area as well as the surrounding ecosystem. After use, Peepoo turns into valuable fertiliser.

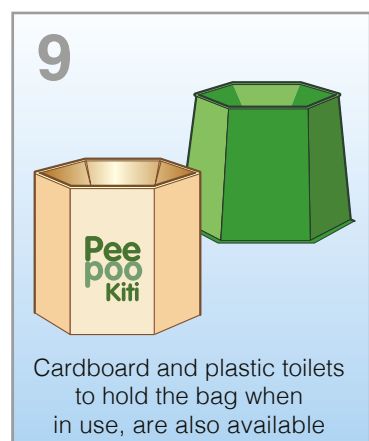
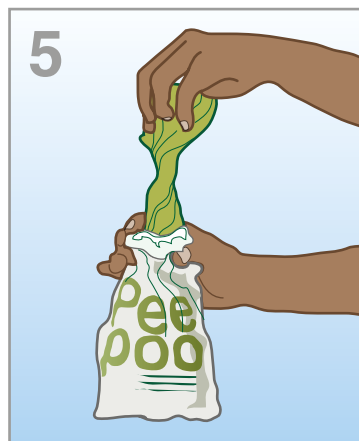
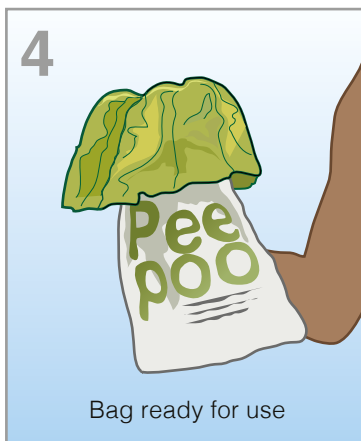

## Links

<http://www.youtube.com/watch?v=UJZhS252tdM>

<http://www.peepoople.com/>

# Piet Urine Diversion Toilet\*

Theo Brandwijk developed the Piet (pee plus seat) toilet that separates urine and faeces. This makes it cheaper to clean the sewage water, and the nitrogen and phosphates can be recycled to produce fertilizer. Piet works with a movement sensor, which opens a three-way valve. The urine is diverted down towards a special drain at the front leading to a tank that is emptied periodically. The faeces disappear through the larger regular drain. The three-way valve automatically closes when the user stands up.

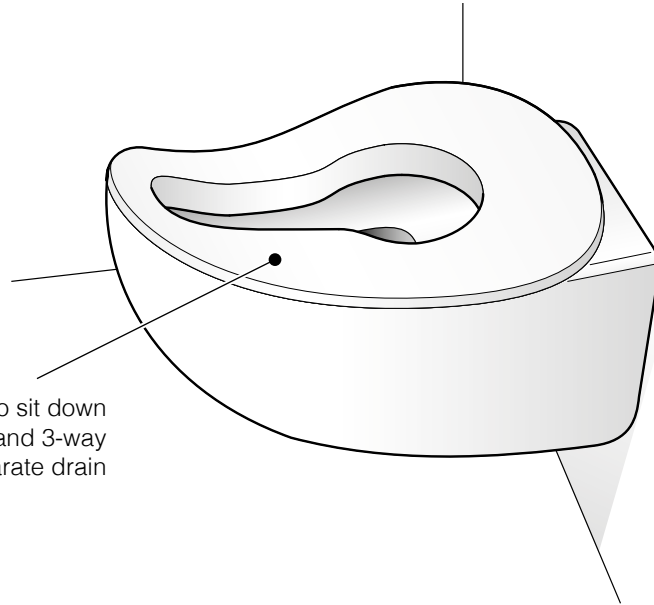

The fixed toilet seat encourages users to sit down which then activates a motion sensor and 3-way valve to direct the urine to a separate drain

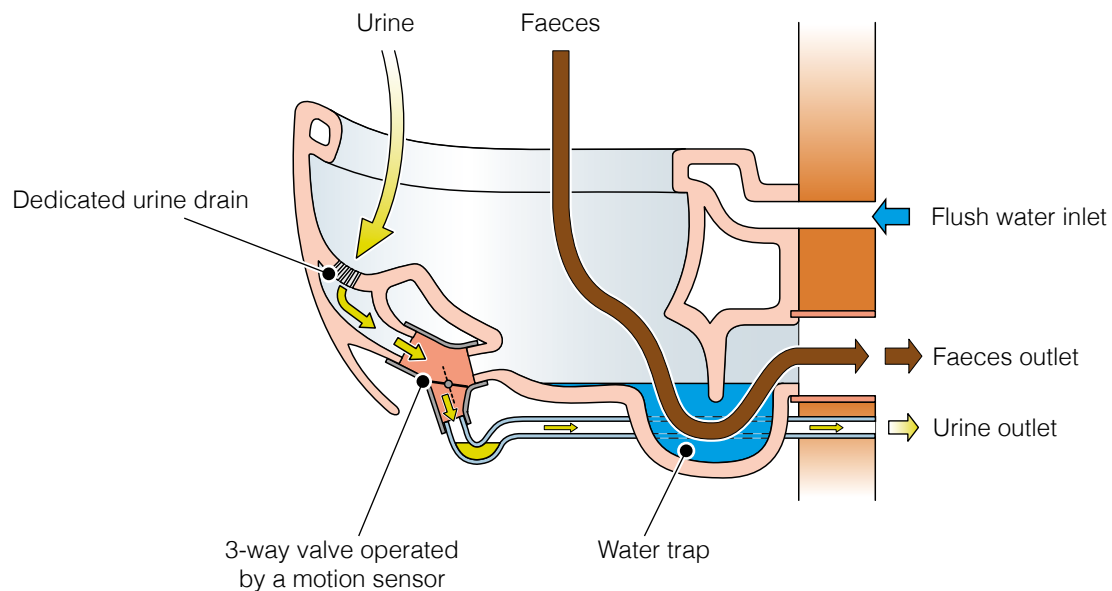

## Links

[http://www.design.nl/item/the\\_problem\\_with\\_poo\\_typischtheo.nl/](http://www.design.nl/item/the_problem_with_poo_typischtheo.nl/)

# Public Rest Room

Designed by Amos Bender, this is a sanitation and composting system for a public rest room (or rest area). The toilet room has four separate toilet basins that keep liquid waste apart from the solid waste and make it easy to add and mix a little soil with the solid waste to aid composting. In this particular composting system there are three separate heaps of waste material, each in a different stage of action spread over three years, with the compost being ready for use as a fertilizer in its third year. (See also pages 6 and 19.)

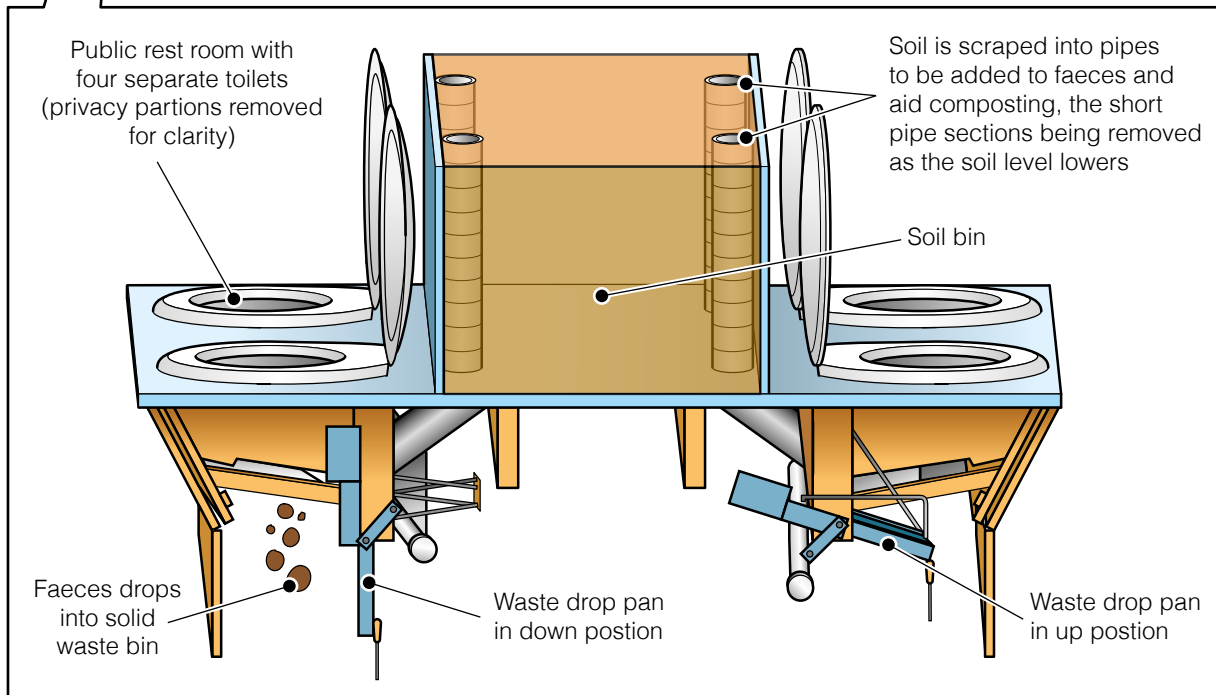
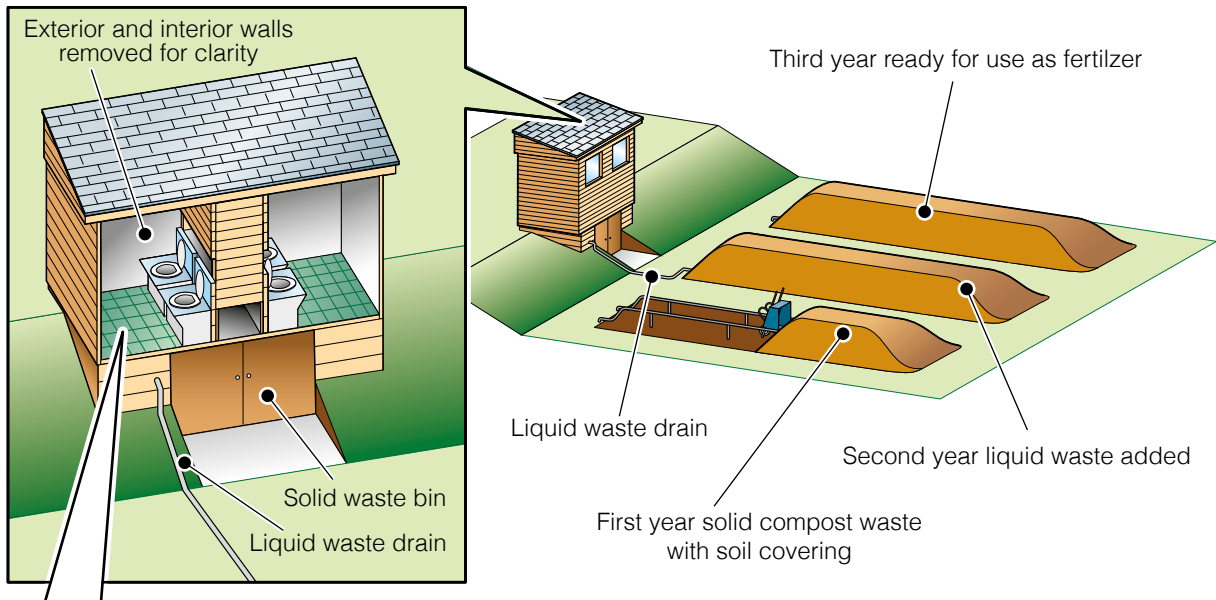

## Links

<http://www.exploringnaturespossibilities.com/>

# Resource Toilet

The Resource is an ultra-low cost toilet with a removable container that makes it easy to collect and transport waste safely from the community. The toilet combines a 20 litre bucket, a liquid container, and a western-style toilet seat into a sealed, portable, urine diverting toilet.

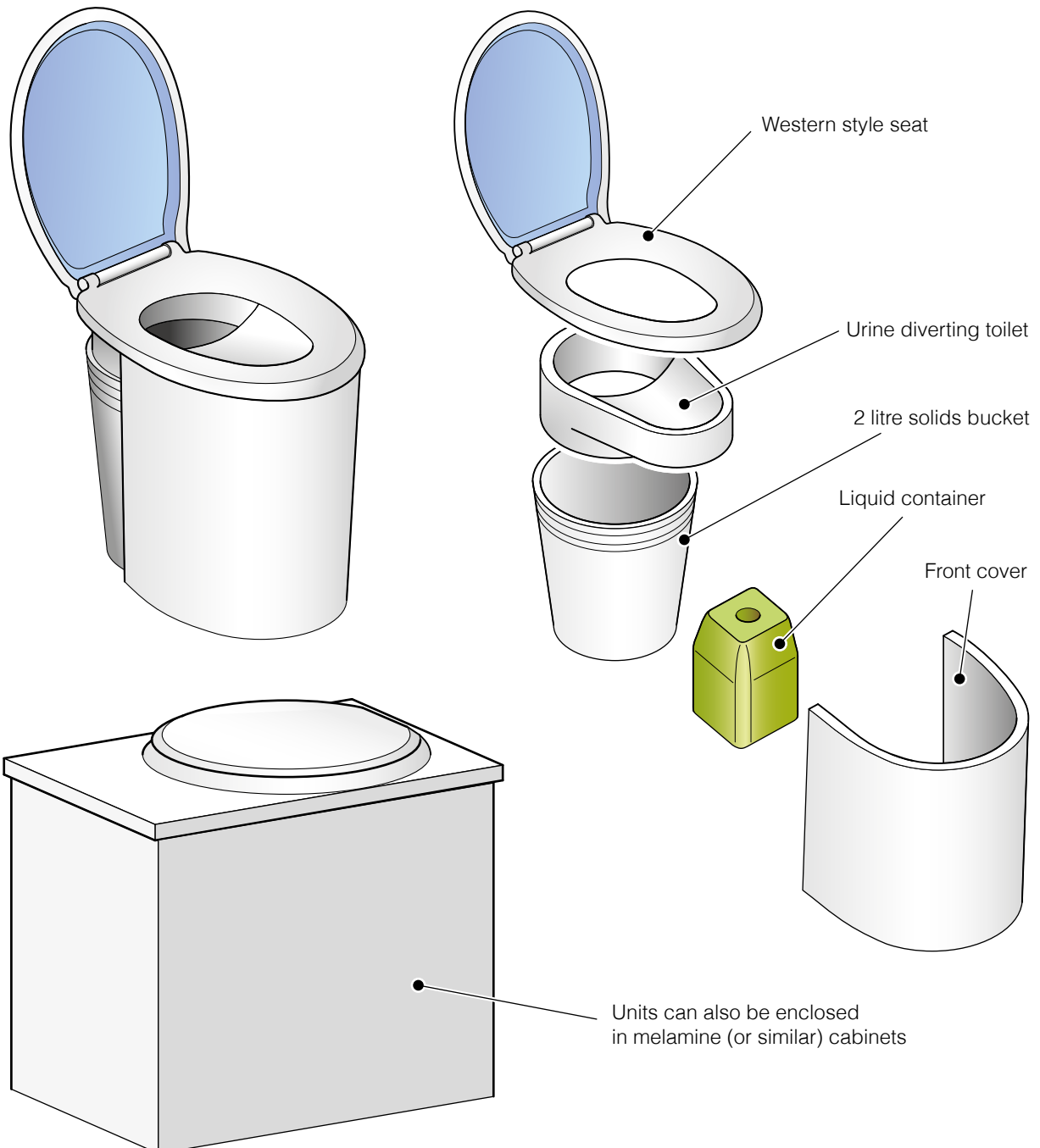

## Links

<http://www.resourcesanitation.com>

<http://resourcesanitation.com/2013/11/14/we-share-our-encyclopedia>

# Rolling Toilet: x-runner

Israel's Noa Lerner, a Berlin-based industrial engineer, designed this toilet for slum dwellers. It consists of a squatting platform, placed over a removable container that can be rolled to a neighbourhood collection facility.

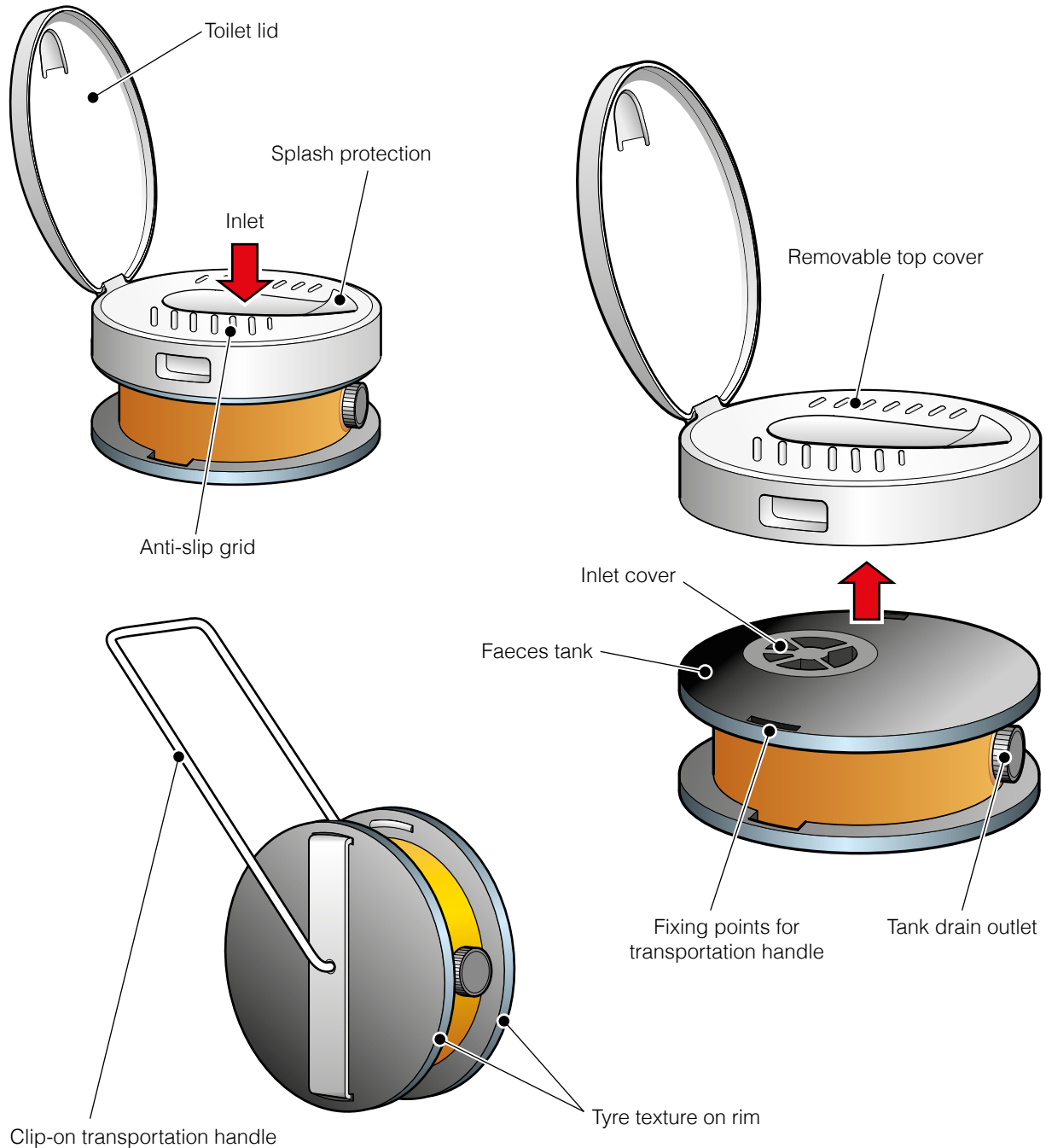

## Links

<http://www.youtube.com/watch?v=NSML-cG46Fo>

<http://www.xrunner-venture.com/>

<http://vimeo.com/51312933#>

<http://www.greenprophet.com/2011/04/israeli-designer-green-toilet-indias-slum-dwellers/>

# SimSan

The SimSan BucketMate from Amos Bender is a simple toilet that makes human waste easy to manage as it can be used with a common bucket with 95% of urine being directed away to another location. The toilet incorporates a unique gate that only needs to be opened for defecating and remains closed at all other times, blocking odour. The bucket is also divided into four individual smaller sections. When one section is full the SimSan toilet is simply rotated to the next providing extra capacity before it requires emptying.

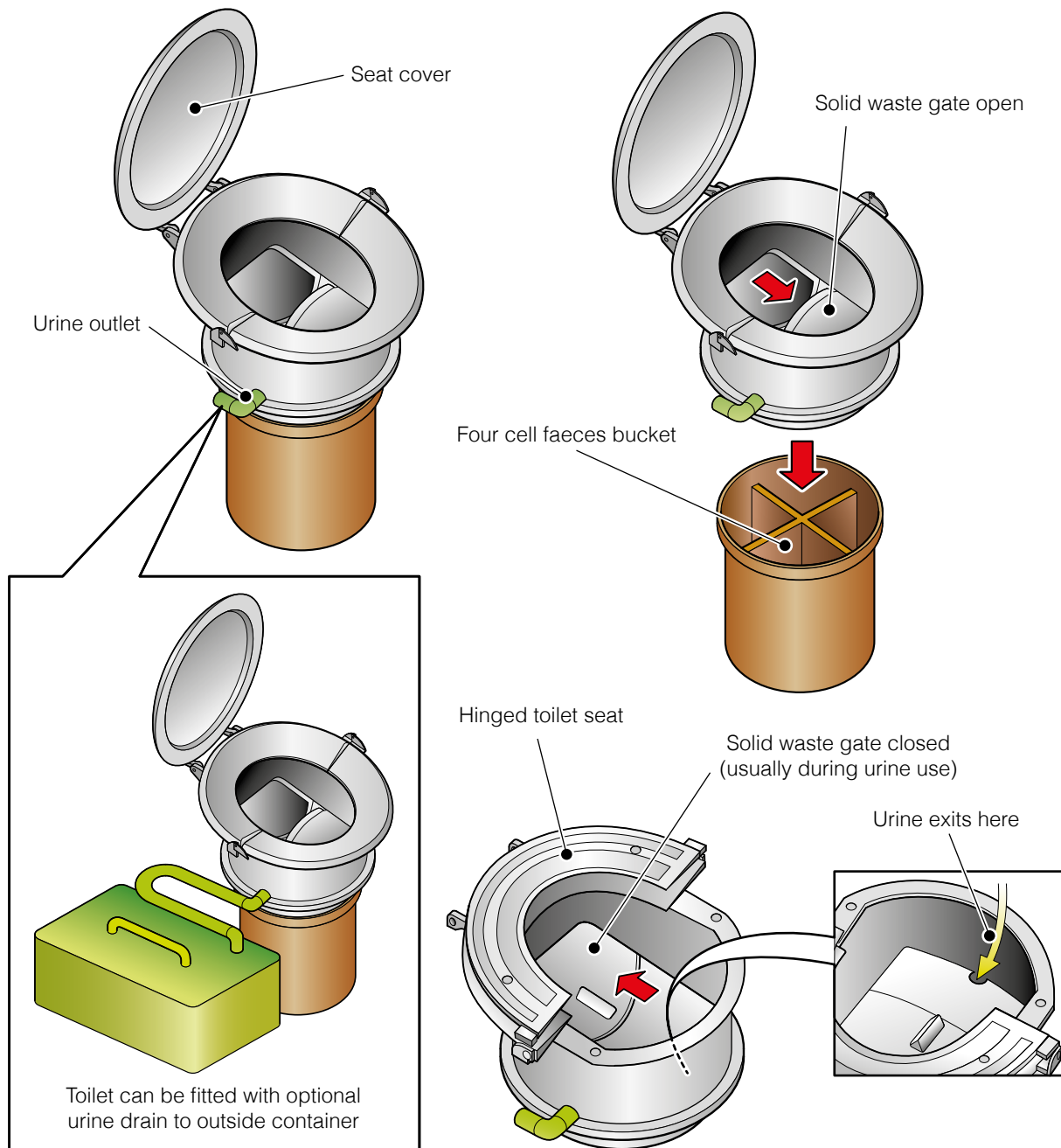

## Links

<http://www.liftupthepoor.net/SimSan.html>

# Waterless Toilet\*

This student project was the second place winner of the Victorinox Time to Care, Sustainable Design Award in September 2011. It doesn't require water to function properly; doesn't generate sewage; is made for urban areas and generates compost suitable for crops and is user-friendly.

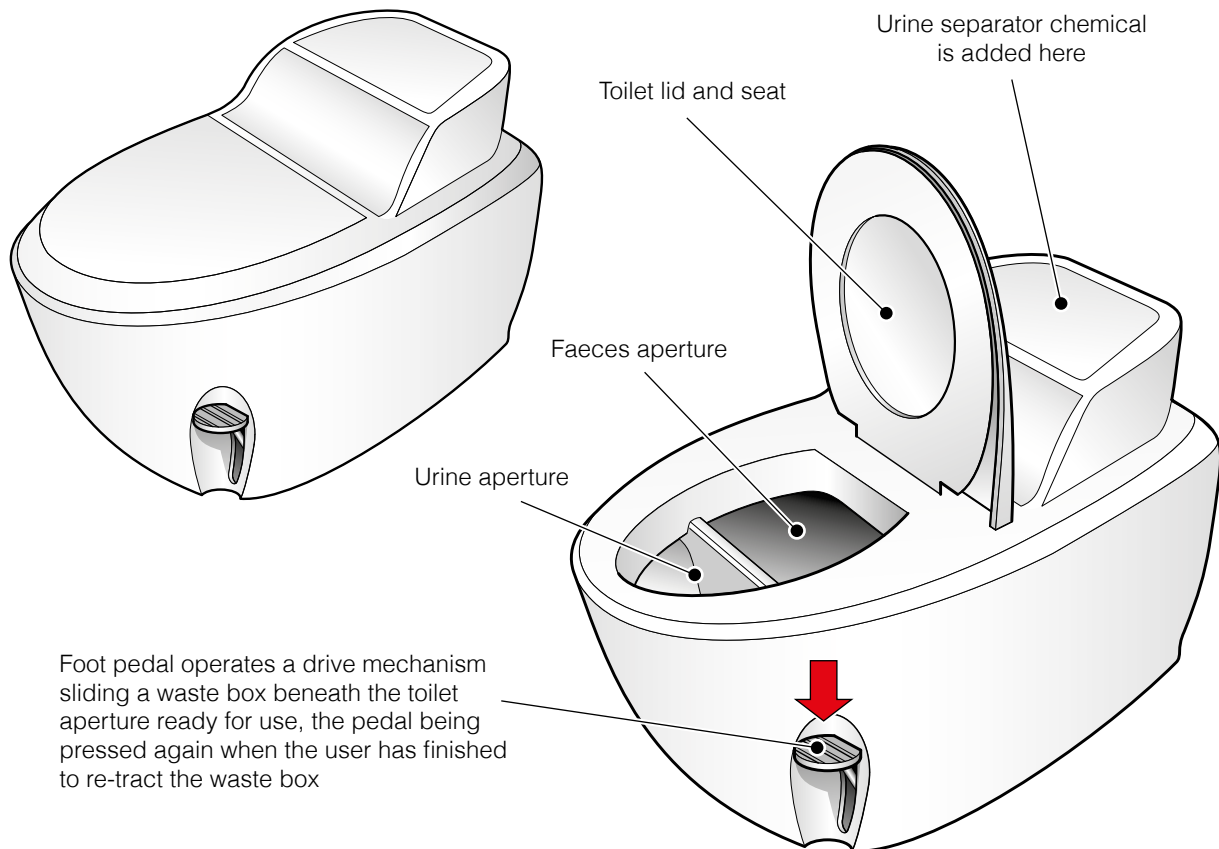

## Links

<http://forum.susana.org/forum/categories/34-urine-diversion-systems-in-cludes-uddt-and-ud-flush-toilet/706-colombiamexico-aguayuda-is-looking-for-a-urinal-design>  
<http://timetocare.victorinox.com/en/nc/vote-win/waterless-toilet.html>



# WC der Zukunft

WC der Zukunft (Toilet of the Future) is a urine diversion composting toilet. Urine can be used either as a fertilizer or simply discharged into the sewage system. Faeces are collected with other recyclable materials and compost.

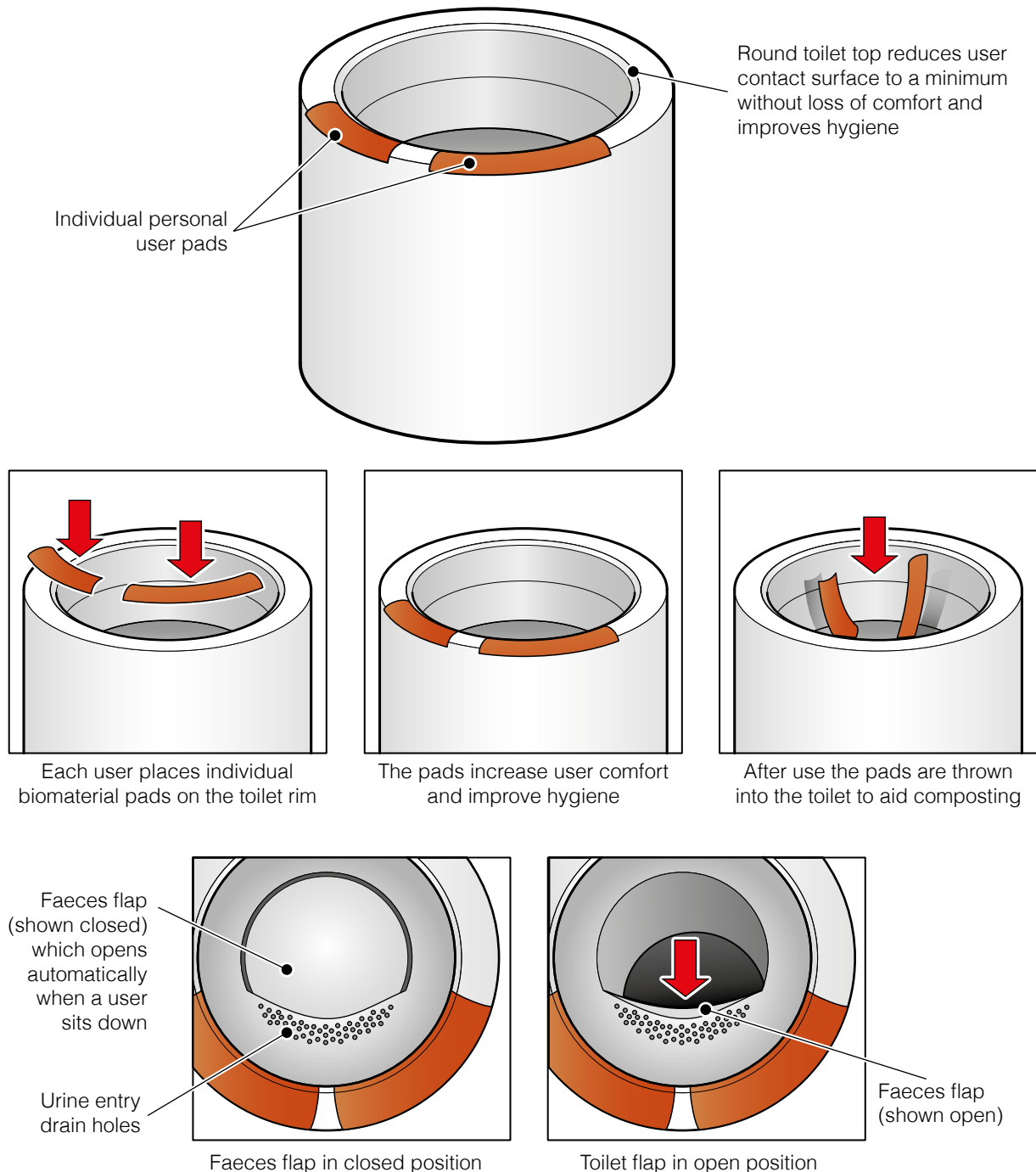

## Links

<http://www.ronja-scholz.de>

# WooWoo

Woo Woo is a London-based company, providing waterless toilets for sale throughout the UK. This free standing, public toilet system functions without water, electricity or chemicals and can be installed virtually anywhere. It offers an ideal solution for sites with no connection to water or sewerage services.

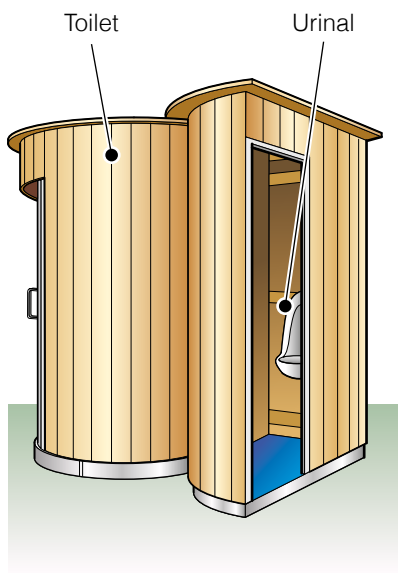
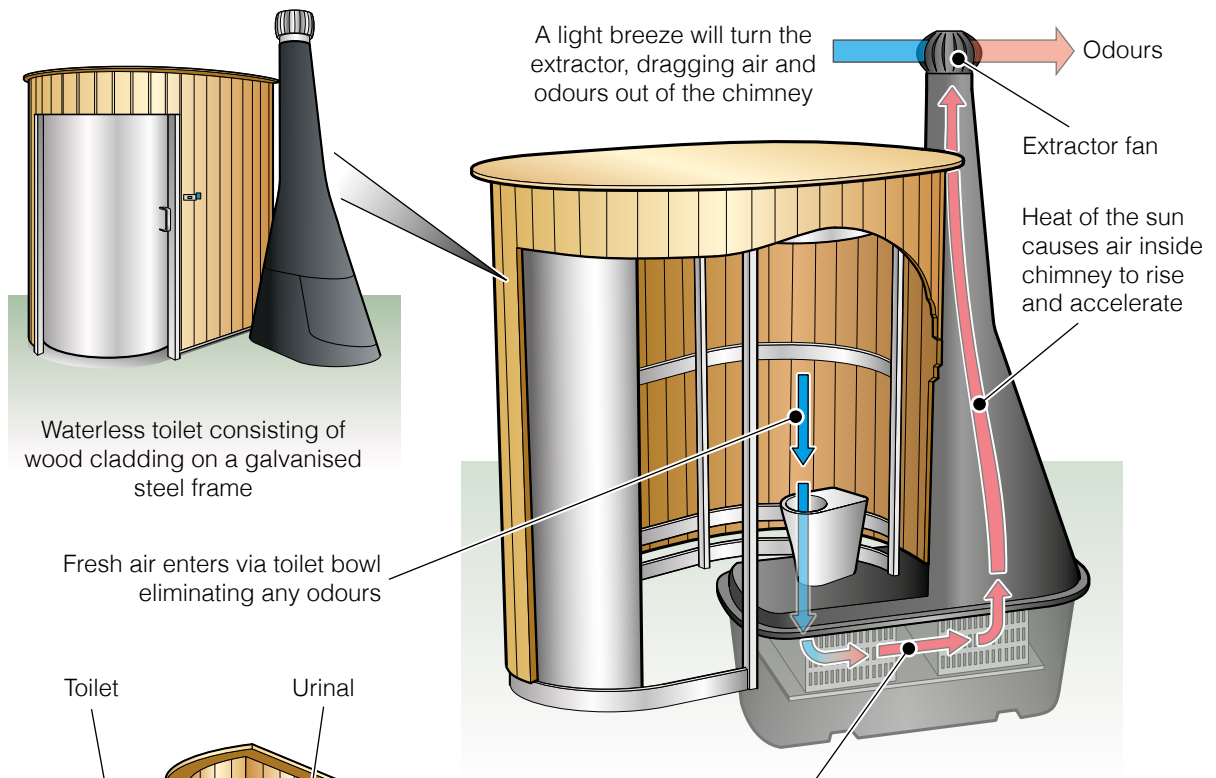

Waterless urinals are also available installed alongside toilet and both linked to the evaporation system

Air streams over separated waste in evaporation unit (installed below ground level) dehydrating solids, evaporating liquids and removing odours

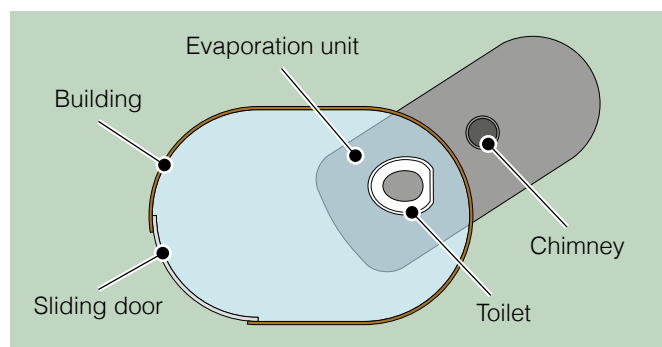

Plan view showing arrangement of polyethylene evaporation unit and chimney to the actual building

## Links

<http://www.waterlesstoilets.co.uk>

# Controlling Odour

# Controlling odour from urine

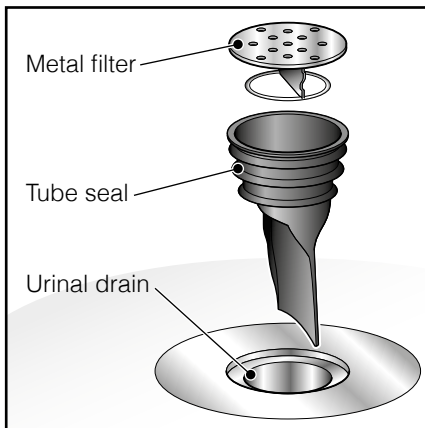

## Rubber tube seal

This rubber tube is flat at the bottom when not in use (and hence blocks odour from the sewer or urine storage tank) but opens up when urine is flowing through. This one-way valve allows passage of grit up to 2mm.

It must be cleaned approximately once per month and replaced every year.

<http://pro.keramag.com/produkte/urinale/centaurus.html>

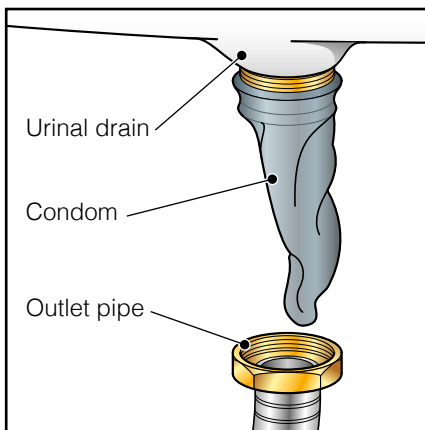

## Condoms – The low-tech alternative

Condoms with the ends trimmed can be used as an effective seal for male urinals.

[http://www.wecf.eu/download/2011/February/SSP-06\\_Jan2011\\_16-221.pdf](http://www.wecf.eu/download/2011/February/SSP-06_Jan2011_16-221.pdf)

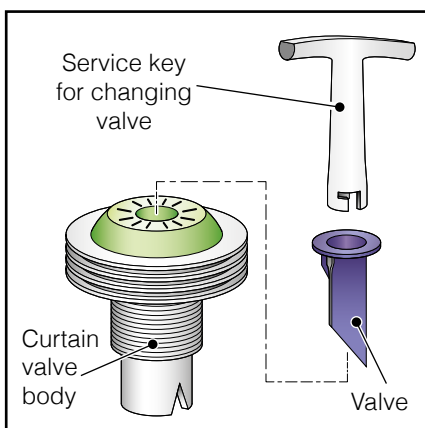

## Valve seals

Valve seals are similar to the rubber tube seal, but are designed to reduce maintenance requirements. This seal has self-cleaning properties, although the production requires complex injection moulding machines, so it is not feasible to produce it locally.

<http://www.autospec.co.za/productmedia/addicom/datasheets/addicomframe.htm>

<http://www.enswico.com/en/technology/key-system.html>

<http://www2.gtz.de/Dokumente/oe44/ecosan/en-waterless-urinals-a-proposal-to-save-water-and-recover-urine-nutrients-in-africa-2009.pdf>

<http://www.culu.eu/zubehoer>

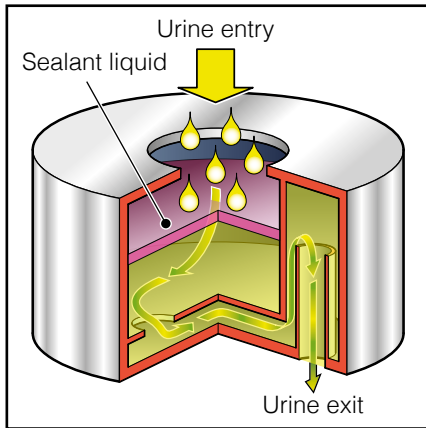

### Sealant liquid

This system works with a sealant liquid (also called blocking fluid) which is made of vegetable oils or aliphatic alcohols. The sealant liquid, floats on top of the urine contained in the trap and thus constitutes an effective odour barrier. Urine immediately penetrates the sealant liquid and flows away to the drain.

<http://www.freepatentsonline.com/6589440.html>

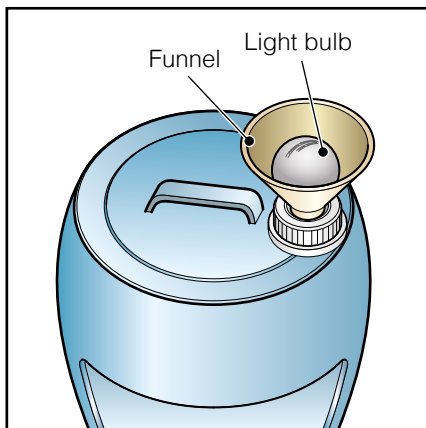

### Light bulb / table tennis ball

Another low-tech solution: an old light bulb is placed in a funnel which in turn is inserted in the opening of a jerrican. This provides a portable and ready-made urinal. The contents should be clearly labelled on the outside of the can which must not be later used for water collection.

# Controlling odour from faeces

## Ventilation

Ventilated improved pit latrines (VIP latrines) can significantly reduce the smell of excreta and can even be more pleasant to use than some other water-based technologies. Flies that hatch in the pit are attracted to the light at the top of the ventilation pipe where they are trapped by a fly-screen and die.

The vent works better in windy areas but where there is little wind, its effectiveness can be improved by painting the pipe black; the heat difference between the pit (cool) and the vent (warm) creates an updraft that pulls the air and odours up and out of the pit.

Ventilating other types of latrine and keeping them clean will also help reduce the odour from faeces.

## Soil, ash, sawdust, sand or lime

By covering the faeces with one of these dry materials, flies and odours are kept to a minimum.

[http://www.eawag.ch/forschung/sandec/publikationen/compendium\\_e/index\\_EN](http://www.eawag.ch/forschung/sandec/publikationen/compendium_e/index_EN)

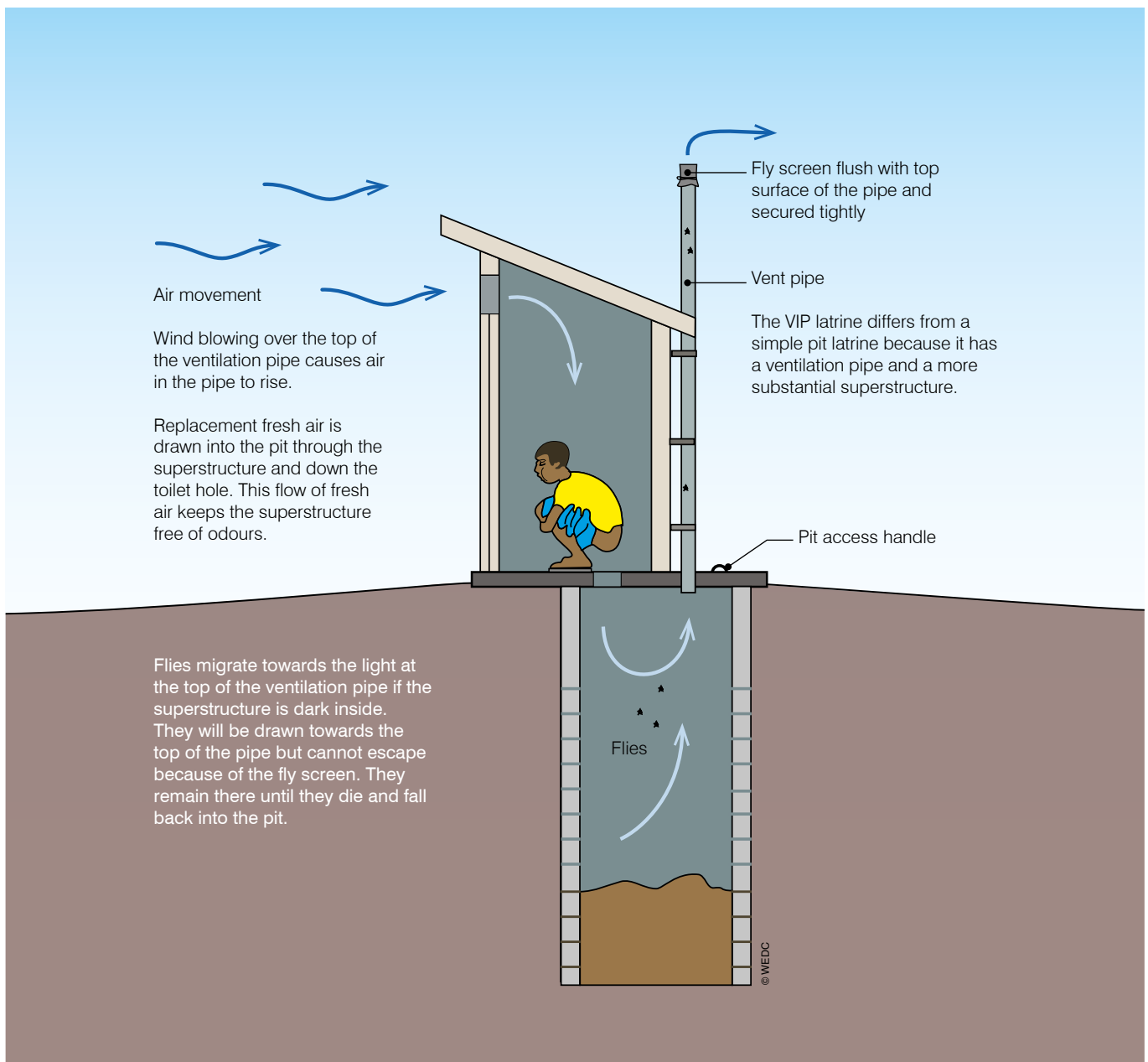



## EOOS

The EOOS design firm was established in Vienna in 1995. EOOS operates in the fields of furniture and product design as well as social design for clients such as Giorgio Armani, Adidas, Alessi, Bene, the Bill & Melinda Gates Foundation, Bulthaup, Dedon, Duravit, Keilhauer, MatteoGrassi, Walter Knoll and Zumtobel. EOOS sees sustainability and the responsible use of materials and resources as an essential part of the design process. For EOOS, design is a poetical discipline and a cultural service for society. To date, EOOS has over 15 technical patents and received more than 70 international awards, including the 2004 renowned Italian Compasso d'Oro award. For the design of the Blue Diversion Toilet EOOS received a 'Special Recognition for Outstanding Design' from the Bill & Melinda Gates Foundation in 2012.

### EOOS

Zelinkagasse 2/6  
1010 Vienna  
Austria

T: +43/1/405 39 87 F: +43/1/405 39 87-80

[www.eoos.com](http://www.eoos.com)

## WEDC

The Water, Engineering and Development Centre is one of the world's leading education and research institutes for developing knowledge and capacity in water and sanitation for sustainable development and emergency relief. WEDC focuses on solutions for people in low- and middle-income countries, helping to provide evidence-based answers to important questions – not only about what needs to be done to improve basic infrastructure and essential services – but also how to go about it.

Founded in 1971, WEDC is based in the School of Civil and Building Engineering at Loughborough University, one of the top award-winning UK universities.

WEDC's core values related to education and knowledge and research are:

**Education:** Teaching, learning and capacity building underpin sustainable developments in water, sanitation and hygiene. It is an indispensable condition of development.

**Knowledge and research:** Knowledge is central to progress. It is not just the generation of new knowledge through research, but using existing knowledge to the full, and working seriously on dissemination and uptake.

WEDC: Water, Engineering and Development Centre  
School of Civil and Building Engineering  
The John Pickford Building  
Loughborough University  
Leicestershire LE11 3TU  
United Kingdom

T: +44 (0)1509 222885 F: +44 (0)1509 211079

E: [wedc@lboro.ac.uk](mailto:wedc@lboro.ac.uk) W: <http://wedc.lboro.ac.uk>